

ACCESSORY BOOK



APRIL 20

CONTENTS

BATTERIES		Saw Stands and Accessories	93	Router Accessories	143
Battery and Charger Guide	3	JIGSAW BLADES		Biscuit Joiner Accessories	146
Battery Adaptors and accessories	5	Universal Fitting	96	Aluminium Groove Cutter Blades	146
Radios and Torches	6	Makita Fitting	98	Planer Accessories	146
Knives and Tape Measures	6	Reciprocating Saw Blades	100	Thickneser Accessories	146
Makpac Connector Cases	8	Jigsaw Accessories	104	Wire Brushes	147
Cases and Bags	11	Chain Mortiser	105	Rebar and Rod Cutter Accessories	148
Makpac Inlays	12	Band Saw Accessories	105	Shear Blades	148
Belts and Pouches	14	MULTI TOOL		Die Grinder Accessories	148
DRILLING		Starlock Accessory Sets	107	Laser Accessories	149
HSS Bits	23	Starlock	107	DUST EXTRACTION	
Countersink Bits	26	Sanding and Polishing	109	Dust Extraction Attachments	151
Cone Drill Bits	27	DIAMOND BLADES		Dust Covers and Collectors	152
Step Drill Bits	27	Nebula	111	Dust Extraction Guards	152
Wood	28	Comet	112	Hose Adaptors	152
Holesaws	31	Quasar	113	Dust Bags and Adaptors	153
Mini Diamond Drills	36	Diamak	113	Dust Extraction Chart	154
Masonry and Concrete	37	X-Lock Diamond Blades	114	Vacuum Cleaners and Accessories	155
Chisel and Points	45	Diamond Blades	114	Heat Gun Accessories	157
Chucks and Keys	50	Vacuum Brazed Diamond	114	GROUND MAINTENANCE, LANDSCAPING AND FORESTRY	
Mixing Blades	51	Tungsten Carbide	114	Chainsaw Clothing	158
Adaptors & Attachments	51	Grinding Heads	114	Disc Cutter Accessories	160
Trolleys	51	Cores Wet Drilling	116	Chainsaw Accessories	160
Drill Stands	51	Cores Dry Drilling	116	Oils	161
Hammer Grease	51	Accessories	118	Chainsaw Bars and Chains	162
FIXING		BONDED ABRASIVES		Brushcutter Blades	164
Impact Gold Bits	52	Cut-off Wheels	121	and Accessories	
Impact Black Bits	55	Cutting Discs	121	Nylon Lines and Heads	165
Torsion Bits	56	Slitting Discs	121	Line Trimmer Accessories	165
Screwdriver Bits	56	Grinding Discs	121	Hedge Trimmer Accessories	166
Bit Holders, guides and drivers	58	X-Lock Grinding Discs	122	Auger Accessories	166
Autofeed Screwdriver Accessories	60	Chop Saw Wheels	122	Pruning Extension Accessories	166
Sockets	61	Pads, Wrenches and Handles	123	Vacuum Set for Blowers	166
Caulking Gun Holders	63	FLAP DISCS AND WHEELS		Mower Blades	166
Grease Gun & Rebar Tying	63	Flap Discs	125	Split-Shaft and	167
Nails	65	Surface Conditioning Discs	127	Brush Cutter Attachments	
Staples	67	Strip Discs	127	Power Washer Accessories	168
Air and Gas	67	Flap Wheels	127		
Drilling and Fixing Bit Sets	68	ABRASIVE BELTS AND SHEETS			
SAW BLADES		Sanding Belts	129		
Efficut	82	Sanding Sheets	131		
Efficut Metal	83	Palm Sanding Sheets	133		
Specialised	84	Sanding Discs	134		
Mforce	89	Floor Sanding	136		
Multi Purpose	89	Sanding Accessories	137		
Makforce	90	ROUTER CUTTERS			
Standard Blades	91	Pro Worker	138		
Makblade	91	Premium	140		
Makblade Plus	92	Router Sets	143		

INVEST IN A PROFESSIONAL AND VERSATILE CORDLESS SYSTEM

POWERFUL - QUIET RUNNING - LIGHTER WEIGHT
NO CABLES - NO PETROL FUMES - LONG RUN TIMES

18V
LITHIUM-ION

BL
MOTOR

18V + 18V → **36V**



ICONS

 Wood	 Sheet Profile	 Leather	 Paint Removal
 Nail Embedded Wood	 Stainless Steel	 Glass Fibre Reinforced Products	 Clean Cut
 Plywood	 Non-Ferrous Metals	 Corrugated Sheet	 High Cutting Performance
 Insulation Material	 Bi-Metal	 Rubber	 Laser Welded
 Laminated Board	 Plexiglass	 Underlay	 Circular Saw
 Block Wood	 Copper Pipe	 Insulation Material	 Plunge Saw
 Fibre Cement Board	 PVC / Plastics	 Not Suitable For Insulation Material	 Mitre Saw
 Hard Board	 Glass	 Clean Cutting	 Cut Off Saw
 Engineered Wood	 Ceramic / Tiles	 Coarse Cutting	 Table Saw
 Chipboard	 Common Brick	 Scroll / Curved Cut	 Palm Sander
 MDF	 Brick / Stone	 Straight Cut	 Sheet Orbit Sander
 Pallet	 Hollow Brick	 Rip Cut	 Belt Sander
 Laminate Board	 Limestone	 Cross Cut	 Petrol Disc Cutter
 Sandwich Materials	 Reinforced Concrete	 Punched Abrasive Sheet	 Random Orbit Sander
 Metal / Steel	 Concrete	 Abrasive Sheet	 Angle Grinder
 Aluminium	 Aerated Concrete	 Hook And Loop Backing	 Delta Sander
 Metal / Mild Steel	 Polystyrene	 Brush	 Angle Sander
 1/2 BSP Fitting	 5/4 UNC Fitting	 Use Dry	 Use with water
 Do Not Use Hammer Mode	 For SDS-PLUS Hammers	 For SDS-MAX Hammers	

18V

LITHIUM-ION

3.0Ah
Li-ion

22 minute
charge time

4.0Ah
Li-ion

36 minute
charge time

5.0Ah
Li-ion

45 minute
charge time

6.0Ah
Li-ion

55 minute
charge time

OVER 200 PRODUCTS
ONE BATTERY SOLUTION



BATTERIES: ADAPTORS AND ACCESSORIES

ADAPTORS

AC ADAPTOR

SE00000498 DMR200
 SE00000066 DMR104/109
 SE00000102 DMR106/108/112
 TE00000213 CF101D/DCF101
 DC1001 CL104D



UMBILICAL ADAPTOR

BAP24

Umbilical battery adaptor for Makstar 24v batteries



UMBILICAL ADAPTOR 36v

BAP36

Umbilical battery adaptor for Makstar 36v batteries



UMBILICAL ADAPTOR 36v

BAP36N

Umbilical battery adaptor for Li-ion 36v batteries BL3626



BATTERY CONVERTER

BCV01

Umbilical battery adaptor. Accepts x2 18v li-ion batteries to convert to one 36v battery.



UMBILICAL ADAPTOR 18v

BAP182

Umbilical battery adaptor. Accepts x2 18v li-ion batteries.



TWIN 18V ADAPTOR FOR BL36120A

197718-3

Adaptor for 36v back-pack battery to twin 18v



BATTERY CONVERTER

BCV03

Accepts x2 18v li-ion batteries to convert to one 36v battery. Not compatible with BHR261.



CONVERTER

193947-6

ADP04 Adaptor 24v



PDC01 PORTABLE POWER SUPPLY 191A59-5 / 191C91-1

191A59-5
 PDC01 Portable Power Supply
 Includes 18v and Twin 18v adaptors.
 BATTERIES NOT INCLUDED



191A64-2
 PDC01 Portable Power Kit
 Includes 2x Batteries, charger
 and Twin 18v adaptor

191C91-1
 PDC01 Portable Power Kit
 Includes 4x Batteries, charge
 and Twin 18v adaptor



Weights 7kg when holding 4 batteries.

USB ADAPTOR 18V

DEBADP05

USB port adaptor for 18V Li-ion batteries.



USB ADAPTOR 12V Max CXT

DEAADP06

USB port adaptor for 12v Max CXT Li-ion batteries.



PROTECTORS AND COVERS

BATTERY PROTECTOR

195797-5

Batteries BL1415, BL1430
 Protects battery when on tool.



BATTERY PROTECTOR

195798-3

Batteries BL1815, BL1830, BL1840,
 BL1850, BL1860
 Protects battery when on tool.



BATTERY PROTECTOR

194649-7

Batteries 18v Li-ion
 Protects battery when on tool.



BATTERY COVER

450128-8

Batteries 18v Li-ion
 Protects battery when not in use.



BATTERIES: BATTERY AND CHARGERS



DC18RE
Twin Port CXT/LXT



DC18RC*



DC18SD



DC18SF
Four Port Charger



DC18RD*
Twin Port Charger



DC18SE
Automotive



18V
Lithium-ion

14.4V
Lithium-ion

6.0
Ah



BL1860B
(197422-4)

55
Minute
Charge
1-2 Batteries

130
Minute
Charge

130
Minute Charge
1-2 Batteries
230
Minute Charge
3-4 Batteries

5.0
Ah



BL1850B
(197280-8)

45
Minute
Charge
1-2 Batteries

110
Minute
Charge

110
Minute Charge
1-2 Batteries
220
Minute Charge
3-4 Batteries

4.0
Ah



BL1840B
(197265-4)

36
Minute
Charge
1-2 Batteries

90
Minute
Charge

90
Minute Charge
1-2 Batteries
180
Minute Charge
3-4 Batteries

3.0
Ah



BL1830B
(197599-5)



BL1430B
(197615-3)

22
Minute
Charge
1-2 Batteries

60
Minute
Charge

60
Minute Charge
1-2 Batteries
120
Minute Charge
3-4 Batteries

2.0
Ah



BL1820B
(632F01-2)

24
Minute
Charge
1-2 Batteries

45
Minute
Charge

45
Minute Charge
1-2 Batteries
90
Minute Charge
3-4 Batteries

*Also available in 110v

Battery capacity measured in line with battery directive 2006/66/EC and EU regulations 11/03/2010. Li-ion IEC61960.
For information on other Makita batteries please visit our website: www.makita.com

18V
Lithium-ion

14.4V
Lithium-ion



DC18WA



1.3
Ah

BL1815G
(198186-3)



BL1415G
(198192-8)



60
Minute Charge

12V
Lithium-ion



DC10SB

DC18RE
Twin Port CXT/LXT

DC10WD



4.0
Ah

BL1041B
(197406-2)



60
Minute Charge

130
Minute Charge

2.0
Ah

BL1021B
(197396-9)



30
Minute Charge

70
Minute Charge

1.5
Ah

BL1016B
(197393-5)



22
Minute Charge

50
Minute Charge

10.8V
Lithium-ion

DC10WA



1.3
Ah

BL1013
(194550-6)



50
Minute Charge

7.2V
Lithium-ion

DC10WA



1.0
Ah

BL0715
(198000-3)



50
Minute Charge

36V
Lithium-ion

12
Ah

BL36120A



Built in
charger

2.2
Ah

BL3622
(195410-5)



DC36RA
£249.00



Batteries & Cases
Tool Holders
Drilling
Fixing
Saw Blades
Jigsaw & Recip
Multi Tool
Diamond
Bonded Abrasives
Flap Discs
Coated Abrasives
Router Cutters
Dust Extraction
Ground Maintenance

RADIO AND TORCHES

RADIOS

12v CXT LI-ION RADIO MR052

FM/AM Radio / AUX in



TORCHES

BULB 18v LI-ION TORCH DML185

Xenon Bulb
Max Run Time 9 Hours / 180 Lumen

BULB SET: A-30542 (x2)



LED 14.4v / 18v LI-ION TORCH DML802

3.2W Single LED
Max Run Time 27 Hours / 180 Lumen
9 head Positions



LED 14.4v / 18v LI-ION TORCH DML801

Half Power 6 x 0.5W LED
Full Power 12 x 0.5W LED
Max Run Time 48 Hours / 240 Lumen



LED 14.4v / 18v LI-ION TORCH DML806

1W Single LED + 20 x 0.5W LED
Max Run Time 71 Hours / 620 Lumen
Can be used as 360° lantern, 180° lantern
or flash light



LED 14.4v / 18v LI-ION TORCH DML803

2.4W LED
Max Run Time 36 Hours / 170 Lumen
Umbilical with clothing clip



LED 14.4v/18v LI-ION HEADLIGHT DML800

1.6W Single LED
Max Run Time 20 Hours / 100 Lumen
7 Position head / IPX-4 Waterproof design



LED 14.4v / 18v FLASHLIGHT DML808

4.9W Single LED
Max Run Time 32 Hours / 190 Lumen



LED 18v LI-ION TORCH DML186

0.08W 6 x LED
Max Run Time 114 Hours / 500 Lumen



LED 14.4v LI-ION TORCH DML146

0.08W 6 x LED
Max Run Time 103 Hours / 500 Lumen



LED 12v / 7.2v LI-ION TORCH ML102

1.25W Single LED
Max Run Time 8 Hours / 100 Lumen
Can be used as a lantern or torch



LED 12v TORCH ML103

1.5W Single LED
Max Run Time 28 Hours / 100 Lumen



CXT 12v WORKLIGHT ML105

4.9W Single LED
Max Run Time 14 Hours / 190 Lumen



LED 12v FLASHLIGHT ML106

4.9W Single LED
Max Run Time 12 Hours / 190 Lumen



LED 12v FLASHLIGHT ML104

2W Single LED + 20 x 0.5W LED
Max Run Time 19 Hours / 710 Lumen
Can be used as 360° lantern, 180° lantern
or flash light



LED 18v G-SERIES TORCH ML187

0.1W 9 x LED
Max Run Time 15 Hours / 48 Lumen



LED WORKLIGHT

LED MAINS 14.4v / 18v LI-ION WORKLIGHT



Light Source	Type	20 x 0.5W LED	
	illuminance 1x	0.5m from light	High 1,150 / Low: 750
		1m from light	High 300 / Low 200
Luminous Flux 1x	High 750 / Low: 450		

DML805

- 360° adjustable knob enables the light section to be rotated 360° up and down
 - Battery capacity warning function
 - 1/4" thread
 - Available in 110v
- Can be mounted on optional tripod or vice



BATTERY RUN TIMES

- 18v Li-ion 5.0Ah**
Low: 17h / High: 8.5h
- 18v Li-ion 4.0Ah**
Low: 13h / High: 6.5h
- 18v Li-ion 3.0Ah**
Low: 10h / High: 5h



DML805 TRIPOD



GM00001381



DML805 CLAMP



GM00001396



FOLDING KNIFE

P-90548



- Quick change mechanism
- Belt clip for easy access
- Accepts all standard utility blades
- Pack includes 10x blades

TAPE MEASURE 8 METRE

P-72986 / P-73003

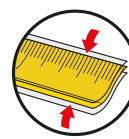

- 25mm nylon coated
- Metric scale
- Imperial scale to 8m
- MID and CE approved
- Drop tested to 2m
- Auto lock
- Magnetic hook end
- 6 in a display box

TAPE MEASURES



- B-68507 - 5.5m
- B-68513 - 7.5m
- B-68529- 10m



	5.5 Metre	7.5 Metre	10 Metre
Coating	Dura Coating	Dura Coating	Silica Coating
2 Sided	YES	YES	YES
Matte Finish	YES	YES	YES
Stand-out	2.4m	2.4m	2.2m
Magnetic Hook	YES	YES	YES
4 Rivet Hook & Protector	YES	YES	YES
Shock Absorber	YES	YES	YES
Hook Protection	YES	YES	YES

Makpac Connector Cases

The smart way to store tools and accessories. The MakPac connector case system consists of four cases varying in height, three tool boxes, two cool boxes and two transport trolleys. The cases can be stacked on top of each other and locked together with the locking latches. Inlays for your tools and accessories are also available.

The interconnected cases take up less storage space and are easy to transport to and from the work site. See full range and www.makita.com



CASES: MAKPAC

TYPE 1 MAKPAC CASE 821549-5

TYPE 1

396mm x 296mm x 105mm

Plastic



TYPE 2 MAKPAC CASE 821550-0

TYPE 2

396mm x 296mm x 157mm

Plastic



TYPE 3 MAKPAC CASE 821551-8

TYPE 3

396mm x 296mm x 210mm

Plastic



TYPE 4 MAKPAC CASE 821552-6

TYPE 4

396mm x 296mm x 315mm

Plastic



TYPE 3 MAKPAC COOL BOX 198254-2



TYPE 3 Cool Box

396mm x 296mm x 210mm

Plastic

11 Litre Capacity

Compatible with Makpac shoulder strap

11L 350ml x15 500ml x10 2000ml x2

TYPE 4 MAKPAC COOL BOX 198253-4

TYPE 4 Cool Box

396mm x 296mm x 315mm

Plastic

18 Litre Capacity

Compatible with Makpac shoulder strap



18L 350ml x30 500ml x20 2000ml x4

MAKPAC STACKABLE TOOL BOX SMALL P-83836

Stackable Tool Box

396mm x 296mm x 145mm

Plastic



MAKPAC STACKABLE TOOL BOX LARGE P-83842

Stackable Tool Box

396mm x 296mm x 325mm

Plastic



MAKPAC STACKABLE CANTILEVER TOOL BOX P-84137

Stackable Cantilever Tool Box

396mm x 296mm x 234mm (inc. handle)

Plastic



MAKPAC CLIP HOLDER VC4210M W107418357

Makpac clip holder for VC4210M

Plastic



Batteries & Cases
Tool Holders
Drilling
Fixing
Saw Blades
Jigsaw & Recip
Multi Tool
Diamond
Bonded Abrasives
Flap Discs
Coated Abrasives
Router Cutters
Dust Extraction
Ground Maintenance

CASES: MAKPAC

MAKPAC LATCH

453974-8

Replacement latch for all Makpac cases



MAKPAC SHOULDER STRAP

196817-8

Shoulder strap for Makpac cases



ACCESSORY INSERT

P-83652

Insert with coloured compartments.

Plastic



ACCESSORY INSERT

P-83680

Insert with 2 compartments (6x dividers)

1x fits in a type 2 case
2x fits in a type 3 case
3x fits in a type 4 case

Plastic



ACCESSORY INSERT

P-83696

Insert with 3 compartments (9x dividers)

1x fits in a type 2 case
2x fits in a type 3 case
3x fits in a type 4 case

Plastic



MAKPAC TROLLEY

TR00000001

Foldable Makpac transporter trolley with inline wheels and securing belt.

Metal



MAKPAC TROLLEY BASE

P-83886

Manoeuvrable Makpac platform on 4 swivel wheels, 2 which are lockable.

Plastic



BLACK CUBE TOOL BAG

831373-8

22.5 x 22.5 x 22.5cm
Hard wearing sturdy storage bag
3 hook and loop internal dividers
Internal pocket storage
Nylon woven fabric
Padded shoulder strap



RT0700 TOOL BAG

831327-5

41 x 35 x 31cm
Heavy duty tool bag
Removable hook and loop dividers
Internal pocket storage
Nylon woven fabric
Removable padded shoulder strap



CASES: FOR ALL MAKITA POWER TOOLS

Part No.	Details	Material
----------	---------	----------



CARRYING CASES FOR CORDLESS MACHINES

824652-1	6270DWPE3	Plastic
824698-7	6904, 6905B	Plastic
153859-5	6935FD, 6980FD,	Plastic
154902-3	6936FDWAE	Plastic
141485-2	BCS550, BSS500, BSS501,	Plastic
141358-9	BDA350, BDA341, BDA351, BPB180	Plastic
158597-4	BDF445, BHP452, BDF452,	Plastic
	BDF442, BHP442, DHP480, DDF480	
141856-3	BDF456, BHP456	Plastic
140392-6	BFS450, BFS440,	Plastic
141257-5	DGA452/450	Plastic
824975-7	BGD800	Plastic
158777-2	BHP453, BDF343, BHP343	Plastic
824861-2	BHR202	Plastic
141643-0	BHR240, BHR241	Plastic
824874-3	BHR261	Plastic
141354-7	BJR181, BJR182	Plastic
153566-0	BJR240	Plastic
141486-0	BJV140, BJV180	Plastic
824982-0	DKP180, BKP180, DK1893	Plastic
141496-7	BPB180	Plastic
141074-3	BPT350, BHR162, BST221	Plastic
153612-9	BSR730S	Plastic
141205-4	BTD140, BTW251, BTP130, BTD132,	Plastic
	BTP140, BDF450, BTD130	
141493-3	BTL060, BTL061, BTL062, BTL063	Plastic
141487-8	BTW150SA, BTW151SA	Plastic
824777-1	BTW450, DTW450	Plastic
141494-1	BUC121, BUC122	Plastic
821766-7	DVR350	Plastic
A84384-3	CL Kits	Plastic
824627-0	DA312, DA392, DA391	Plastic
824550-9	DA391D, HR160D	Plastic
824842-6	DF030D, DF011D, TD090, DF330	Plastic
831362-3	DF330DWXP	Fabric
824958-7	GA9020/7020	Plastic
824708-0	HM0860C	Plastic
823308-3	LCT204, LCT303	Aluminium
140354-4	LXT202, LXT232, BDF441, BDF451,	Plastic
	BHP451, BHP441, BDF450	
831276-6	TD020DSE	Fabric
141353-9	DSS611, DSS610	Plastic
141352-1	BFR540, BFR550, BFR750	Plastic
824852-3	8271D, 8281D, 8381D	Plastic
821737-4	DDA460	Plastic
452198-3	DUM165	Plastic
821746-3	DHR400	Plastic
821725-1	DTR180	Plastic
832074-1	DLX2248PT1	Cloth Bag
143644-4	TD30D/TM30D	Plastic

MEDIUM CARRY BAG

831278-2

LXT400 - 60 x 36 x 30cm
Heavy duty tool bag
Hard wearing nylon weave material
Multiple internal and external pockets for storage
Padding throughout
Plastic skids on base



Part No.	Details	Material
----------	---------	----------



CARRYING CASES FOR MAINS MACHINES

824540-2	3901	Plastic
153603-0	8406	Plastic
824944-8	1902 1923B 1923H	Plastic
824002-0	2012NB	Plastic
824809-4	4351	Plastic
824554-1	5703R	Plastic
824651-3	5704RK	Plastic
824439-1	6904vh	Plastic
824522-4	8406C, 8406	Plastic
824985-4	9553NB/9555NB	Plastic
824562-2	BTW150SA	Plastic
824591-5	BO6040	Plastic
824646-6	DA4000LR	Plastic
84001020	DBM131	Steel
824875-1	GN900SE	Plastic
824523-2	HK0500	Plastic
150879-0	HM0810	Plastic
824905-8	HM0870, HM0871	Plastic
150583-1	HM1200K	Plastic
824826-4	HM1304/B	Steel
824897-1	HM1317C / CB	Plastic
824811-7	HP1631K	Plastic
824923-6	HP1640K, HP1641K	Plastic
824608-4	HP2040, HP2041	Plastic
824650-5	HR1830, HP2050, HP2051, HP2070,	Plastic
	HP2071, HR2020, HR2440, HR2450	
824799-1	HR2230, 2460, 2470	Plastic
824789-4	HR2811	Plastic
824825-6	HR3210CT/SMAK	Plastic
824539-7	JR3060T, JR3070CT	Plastic
821621-3	JR3050T	Plastic
824892-1	KP0800	Plastic
181789-0	PC1100	Steel
140073-2	PC5000C	Steel
824880-8	RP0900	Plastic
824709-8	SG1250	Plastic
824703-0	TW0200/ 250	Plastic
824702-2	TW0350	Plastic
824737-3	TW1000	Plastic
824998-5	JV0600K	plastic
98C360	RP801X/RP2301X	plastic
824908-2	HM1213	plastic
824559-1	HR3000C	plastic
150582-3	HR5000K/HR38	plastic
824519-3	HR5001C	plastic
824786-0	KP0810	plastic
OTHER		
824841-8	AN943	Plastic
GENERAL CASES		
P-04101	Universal Case	Steel
	Drill Screwdrivers & Hammers Up to 2kg	
824964-2	Universal Case 280mm	Plastic
824904-0	HM0871C	Plastic
140561-9	VC4210M	Plastic
821718-8	JR3061T	Plastic
821781-1	HR2650	Plastic
140B63-7	PC5010	Steel

LARGE CARRY BAG

831279-0

LXT600 - 70 x 36 x 38cm
Heavy duty tool bag
Hard wearing nylon weave material
Multiple internal and external pockets for storage
Padding throughout
Plastic skids on base



CASES: MAKPAC INLAYS

Part No.	Details	Material
TYPE 1 821549-5		
837664-5	JR100DWJ, JR102DWJ, JR102DZJ	Plastic
837665-3	JV100DWJ, JV100DZJ	Plastic
837695-4	DA330DWJ, DA330DZJ, DA331DWJ, DA331DZJ	Plastic
837696-2	DK1481J, DK1482J	Plastic
837803-7	4327J, 4329J, 4350CTJ, 4350FCTJ, 4350TJ, 4351CTJ, 4351FCTJ, 4351TJ, JV0600J	Plastic
837866-3	DF030DWJ, DF030DWJX1, DF030DWLJ, DF030DZJ, DF330DWJ, DF330DWJX2, DF330DWLJ, DF330DWLJ1, DF330DZJ, HP330DWJ, HP330DWLJ, HP330DZJ, TD090DWJ, TD090DWJX1, TD090DZJ, TW100DWJ	Plastic
837867-1	DK1488J	Plastic
837869-7	6904VJ, 6952J, 6953J, TW0200J	Plastic
837871-0	DF010DSJ, DF010DZJ, TD021DSJ	Plastic
837872-8	6822J, DP4700J	Plastic
837875-2	LCT204J, LCT303JX	Plastic
837876-0	6842J, 6842JX, 6843J, 6843JX	Plastic
837880-9	DA3010FJ, DA3011FJ	Plastic
837881-7	JR1000FTJ	Plastic
837882-5	JN1601J, JS1602J	Plastic
837895-6	3706J	Plastic
838027-8	JS1000J, JS1601J	Plastic
838030-9	6413J, DP2010J, DP2011J, FS2300J, FS2500J, FS2700J, FS4000J, FS4300J, FS6300J	Plastic
838038-3	HP1630J, HP1631J, HP1640J, HP1641FJ, HP1641J	Plastic
838039-1	DP3003J, DP4001J, DP4003J, DP4011J, HP2051FHJ, HP2051FJ, HP2051HJ, HP2051J, HP2051FJ, HP2071FJ, HP2071J	Plastic
838062-6	DCO180Y1J, DCO180ZJ	Plastic
838312-9	DF031DSAJ, DF031DSMJ, DF031DY1J, DF032DSAJ, DF032DSMJ, DF032DY1J, DF032DZJ, DF331DSAJ, DF331DSMJ, DF331DY1J, DF332DSAJ, DF332DSMJ, DF332DY1J, DF332DZJ, HP331DSAJ, HP331DSMJ, HP331DY1J, HP332DSAJ, HP332DSMJ, HP332DZJ, HP332DY1J, HP332DZJ, TD110DSAJ, TD110DSMJ, TD110DY1J, TW140DWAE, TW140DZ, TW060DWAE, TW060DZ, TW161DSAJ, TW161DZ, TW160DSAJ, TW160DZ, TW141DWAE, TW141DZ	Plastic
838313-7	JR103DSAJ, JR103DSMJ, JR103DY1J, JR105DSMJ	Plastic
838439-5	CLX201SAJ, CLX201SMJ, CLX400SAJ1	Plastic
838563-4	JV101DSAJ, JV101DSMJ, JV101DY1J	Plastic
837948-1	18v Li-ion Battery and charger	Plastic
TYPE 3 821551-8		
837628-9	DCS550RFJ, DCS550RMJ, DCS550RTJ, DCS550Y1J, DCS550ZJ, DSS500RFJ, DSS500RMJ, DSS500Y1J, DSS500ZJ, DSS501RFJ, DSS501RMJ, DSS501RTJ, DSS501Y1J, DSS501ZJ, DCS552RTJ, DCS552Z	Plastic
837631-0	DFR440RFJ, DFR440ZJ, DFR450RMJ, DFR540RFJ, DFR540RMJ, DFR540ZJ, DFR550RFJ, DFR550RMJ, DFR550RMJX, DFR550RTJ, DFR550Y1J, DFR550ZJ	Plastic
837634-4	DHR202RFJ, DHR202RMJ, DHR202RTJ, DHR202Y1J, DHR202ZJ	Plastic
837641-7	DHR241RFJ, DHR241RMJ, DHR241RTJ, DHR241ZJ	Plastic
839387-1	DHR171RMJ	Plastic
837642-5	DSS610RFJ, DSS610RMJ, DSS610RTJ, DSS610Y1J, DSS610ZJ	Plastic
837645-9	DTW1001RFJ, DTW1001RMJ, DTW1001RTJ, DTW1001ZJ, DTW1002RFJ, DTW1002RMJ, DTW1002RTJ, DTW1002ZJ, DTW450RFJ, DTW450RMJ, DTW450RTJ, DTW450Y1J, DTW450ZJ, DTW800RFJ, DTW800RMJ, DTW800RTJ	Plastic
837648-3	DPJ140RFJ, DPJ140RMJ, DPJ140ZJ, DPJ180RFJ, DPJ180RMJ, DPJ180RTJ, DPJ180Y1J, DPJ180ZJ	Plastic
837652-2	9403J	Plastic
837653-0	9404J	Plastic
837654-8	BO6030J, BO6030JX	Plastic
837655-6	BO6040J	Plastic
837658-0	9910J, 9911J	Plastic
837659-8	KP0800J, KP0810CJ, KP0810J	Plastic
837660-3	RP0910JFA, RP1110CJFA	Plastic
837661-1	PJ7000J	Plastic
837671-8	DLX2154TJ1, DTM40RFJ, DTM40RFJX3, DTM40RMJ, DTM40ZJ, DTM40ZJX3, DTM41RFJ, DTM41RMJ, DTM41RMJX3, DTM41Y1J, DTM41ZJ, DTM50RFJ, DTM50RFJX2, DTM50RFJX3, DTM50RFJX4, DTM50RFJX6, DTM50RMJ, DTM50RMJX2, DTM50ZJ, DTM50ZJX1, DTM50ZJX2, DTM50ZJX3, DTM50ZJX4, DTM51RFJ, DTM51RFJX3, DTM51RFJX6, DTM51RMJ, DTM51RMJX1, DTM51RMJX2, DTM51RMJX3, DTM51RTJ, DTM51RTJX2, DTM51Y1J, DTM51ZJ, DTM51ZJX1, DTM51ZJX2, DTM51ZJX3, DTM51ZJX6, DJN160RFJ, DJN160RMJ, DJN160ZJ, DJN161RFJ, DJN161RMJ, DJN161RTJ, DJN161Y1J, DJN161ZJ	Plastic
837789-5	DJV141RFJ, DJV141RMJ, DJV141RTJ, DJV141ZJ, DJV141Y1J, DJV141ZJ, DJV181RFJ, DJV181RMJ, DJV181RTJ, DJV181Y1J, DJV181ZJ	Plastic
837808-7	DKP180RFJ, DKP180RMJ, DKP180RTJ, DKP180Y1J, DKP180ZJ	Plastic
837864-7	DK1817JX, DLX2000MJ, DLX2000TJ, DLX2001MJ, DLX2003MJ, DLX2005JX1, DLX2006JX1, DLX2012JX1, DLX2014J, DLX2014JX, DLX2014MJ, DLX2014MJJ, DLX2015MJX, DLX2022AJ, DLX2022CJ, DLX2022YJ, DLX2061MJ1, DLX2121AJ, DLX2121J, DLX2127MJ, DLX2127MJ1, DLX2141AJ, DLX2131JX1, DLX2173TJ, DLX2283TJ	Plastic
837865-5	DLX2008JX	Plastic
837877-8	9902J, 9903J, 9920J	Plastic
837878-6	1911BJ, N1923BJ	Plastic
837879-4	CC300DWJ, CC300DZJ	Plastic
837893-0	DDF343RHLJ, DDF446RFLJ, DDF448RFLJ, DDF453RYLJ, DDF456RFLJ, DDF456RYLJ, DDF458RFLJ	Plastic
838023-6	DBN500RFJ, DBN500RMJ, DBN500RTJ, DBN500Y1J, DBN500ZJ	Plastic
838026-0	9741J	Plastic
838107-0	DLX2004MJ, DLX2040MJ1, DLX2040TJ1, DLX2054MJ1, DLX2118MJ, DLX2119MJ, DLX2132MJ, DLX2176TJ	Plastic
838109-6	DHR162RFJ, DHR162RMJ, DHR162Y1J, DHR162ZJ, DHR164RFJ, DHR164RMJ, DHR164Y1J, DHR164ZJ, DHR165RMJ, DHR165RTJ, DHR165Y1J, DHR165ZJ	Plastic
838175-3	DGA454RMJ, DGA504RFJ, DGA504RMJ, DGA504RTJ, DGA504RTJ2, DGA504RTJ3, DGA504Y1J, DGA504ZJ, DGA505RFJ, DGA505RMJ, DGA505RTJ, DGA505RTJ1, DGA505Y1J, DGA505ZJ, DGA506RFJ, DGA506RMJ, DGA506RTJ, DGA506Y1J, DGA506ZJ, DGA508RFJ, DGA508RMJ, DGA508RTJ, DGA508Y1J, DGA508ZJ	Plastic
838181-8	DS4012J	Plastic
838182-6	DHS680RFJ, DHS680RMJ, DHS680RTJ, DHS680Y1J, DHS680ZJ	Plastic
838246-6	BO6050J	Plastic
838258-9	DLX2065PMJ, DLX2065PTJ, DLX2101PMJ	Plastic
838269-4	DCS551RMJ, DCS551RTJ, DCS551Y1J, DCS551ZJ	Plastic
838314-5	HS6601J	Plastic
839751-6	DCS553ZJ	Plastic
839752-4	DHS660RTJ, DHS660Z, DHS661ZU	Plastic
839527-1	DSC102ZJ	Plastic



CASES: MAKPAC INLAYS

TYPE 2 821550-0		
837630-2	JN3201J, JS3201J	Plastic
837632-8	DGA452RFJ, DGA452RMJ, DGA452RTJ, DGA452Y1J, DGA452ZJ	Plastic
837636-0	DJS101RFJ, DJS101RMJ, DJS101RTJ, DJS101Y1J, DJS101ZJ, DJS160RFJ, DJS160RMJ, DJS160ZJ, DJS161RFJ, DJS161RMJ, DJS161RTJ, DJS161Y1J, DJS161ZJ	Plastic
837639-4	DJV140RF1J, DJV140RFJ, DJV140RM1J, DJV140RMJ, DJV140Y1J, DJV140ZJ, DJV142RFJ, DJV142RM1J, DJV142RMJ, DJV142Y1J, DJV142ZJ, DJV180RF1J, DJV180RFJ, DJV180RM1J, DJV180RMJ, DJV180Y1J, DJV180ZJ, DJV182RFJ, DJV182RM1J, DJV182RMJ, DJV182Y1J, DJV182ZJ	Plastic
837640-9	DPT350RFJ, DPT350RMJ, DPT350Y1J, DPT350ZJ, DPT351RFJ, DPT351RMJ, DPT351RTJ, DPT351Y1J, DPT351ZJ, DST110RFJ, DST110RMJ, DST110ZJ, DST220RFJ, DST220RMJ, DST220ZJ, DST221RFJ, DST221RMJ, DST221Y1J, DST221ZJ	Plastic
837644-1	DTL060RF1J, DTL060RFJ, DTL060RM1J, DTL060RMJ, DTL060ZJ, DTL061RF1J, DTL061RFJ, DTL061RM1J, DTL061RMJ, DTL061RTJ, DTL061ZJ, DTL062RFJ, DTL062RMJ, DTL062ZJ, DTL063RFJ, DTL063RMJ, DTL063ZJ	Plastic
837646-7	RP0900J, RP0900XJ	Plastic
837651-4	HR2300J, HR2600J, HR2601J, HR2610J, HR2611FJ, HR2630J, HR2631FJ	Plastic
837660-3	RP0910J, RP1110CJ	Plastic
837662-9	HS300DWJ, HS300DZJ	Plastic
837670-0	BTP130RFJ, BTP130ZJ, DTD129RFJ, DTD129RHJ, DTD129RMJ, DTD129RMJ1, DTD129RTJ, DTD129Y1J, DTD129ZJ, DTD134RF3J, DTD134RFJ, DTD134RMJ, DTD134Y1J, DTD134ZJ, DTD136RFJ, DTD136RMJ, DTD136Y1J, DTD136ZJ, DTD137RFJ, DTD137RMJ, DTD137Y1J, DTD137ZJ, DTD146RF3J, DTD146RFJ, DTD146RMJ, DTD146RMJ1, DTD146Y1J, DTD146ZJ, DTD147RFJ, DTD147RMJ, DTD147Y1J, DTD147ZJ, DTD148RFJ, DTD148RMJ, DTD148RTJ, DTD148Y1J, DTD148ZJ, DTD152RM3J, DTD152RMJ, DTD152RTJ, DTD152Y1J, DTD152ZJ, DTP131RFJ, DTP131RFJ1, DTP131RMJ, DTP131Y1J, DTP131ZJ, DTP131ZJX1, DTP140RFJ, DTP140RMJ, DTP140Y1J, DTP140ZJ, DTP141RFJ, DTP141RFJ1, DTP141RFJX, DTP141RMJ, DTP141RTJ, DTP141Y1J, DTP141ZJ, DTP141ZJX1, DTS130RFJ, DTS130RMJ, DTS130ZJ, DTS131RFJ, DTS131RMJ, DTS131Y1J, DTS131ZJ, DTS141RFJ, DTS141RMJ, DTS141Y1J, DTS141ZJ, DTW250RFJ, DTW250RMJ, DTW250Y1J, DTW250ZJ, DTW251RFJ, DTW251RMJ, DTW251Y1J, DTW251ZJ, DTW280RFJ, DTW280RMJ, DTW280Y1J, DTW280ZJ, DTW281RFJ, DTW281RMJ, DTW281RTJ, DTW281Y1J, DTW281ZJ, DTW180RMJ, DTW180Z, DTD171Z, DTW181Z	Plastic
837671-8	DLX3000J, DLX3016MJ	Plastic
837672-6	GA5040CJD, GA5040JD, GA5040RKDJ	Plastic
837673-4	TM3000CJ, TM3000CX1J, TM3000CX2J, TM3000CX3J	Plastic
837674-2	3708FCJ, 3710J	Plastic
837675-0	BO4900VJ, BO4901J	Plastic
837773-0	TM3010CJ, TM3010CX1J, TM3010CX2J, TM3010CX3J, TM3010CX4J, TM3010CX6J	Plastic
837805-3	DFS441RFJ, DFS441RMJ, DFS441ZJ, DFS451RFJ, DFS451RMJ, DFS451Y1J, DFS451ZJ, DFS452RAJ, DFS452RFJ, DFS452RMJ, DFS452RTJ, DFS452Y1J, DFS452ZJ	Plastic
837806-1	DGD800RFJ, DGD800RMJ, DGD800RTJ, DGD800Y1J, DGD800ZJ	Plastic
837809-5	DBO140RFJ, DBO140ZJ, DBO180RFJ, DBO180RMJ, DBO180RTJ, DBO180Y1J, DBO180ZJ	Plastic
837862-1	DTD129SHJ, DTD129SYJ	Plastic
837863-9	DDF343RH3J, DDF343RHJ, DDF343RYJ, DDF343SHJ, DDF343SYJ, DDF446RY1J, DDF446Y1J, DDF453RA3J, DDF453RAJ, DDF453RHJ, DDF453RY3J, DDF453RYJ, DDF453SHJ, DDF453SYJ, DDF456RAJ, DDF456RYJ, DDF459RAJ, DDF459RHJ, DDF459RYJ, DDF459SHJ, DDF459SYJ, DDF480RAJ, DDF480Y1J, DHP343RHJ, DHP343RYJ, DHP343SHJ, DHP446Y1J, DHP453RAJ, DHP453RHJ, DHP453RYJ, DHP453SHJ, DHP459SHJ, DHP459SYJ, DHP480RAJ, DHP480Y1J	Plastic
837868-9	HR2811FJ, HR2811FTJ	Plastic
837870-2	TW0350J	Plastic
837874-4	BO5031J, BO5041J	Plastic
837897-2	DJR143RM1J, DJR143Y1J, DJR145RM1J, DJR145ZJ, DJR183RM1J, DJR183RMJ, DJR183RTJ, DJR183RYJ, DJR183Y1J, DJR183ZJ, DJR185RM1J, DJR185RT1J, DJR185ZJ	Plastic
837914-8	HR2610TJ, HR2611FTJ, HR2630TJ, HR2631FTJ	Plastic
837916-4	DDF343RYLJ, DDF441RFJ, DDF441RMJ, DDF441ZJ, DDF444RFJ, DDF446RF3J, DDF446RFJ, DDF446RM3J, DDF446RMJ, DDF446ZJ, DDF448RFJ, DDF448RMJ, DDF448Y1J, DDF448ZJ, DDF451RFJ, DDF451RMJ, DDF451RTJ, DDF451Y1J, DDF451ZJ, DDF453RF3J, DDF454RF3J, DDF454RFJ, DDF456M3WJ, DDF456RF3J, DDF456RFJ, DDF456RFWJ, DDF456RFHJ, DDF456RM3J, DDF456RMJ, DDF456SP1J, DDF456ZJ, DDF458RF3J, DDF458RFJ, DDF458RM3J, DDF458RMJ, DDF458RTJ, DDF458Y1J, DDF458ZJ, DDF459RF3J, DDF459RFJ, DDF459RM3J, DDF459RMJ, DDF459RTJ, DDF459Y1J, DDF459ZJ, DDF470RF3J, DDF470RFJ, DDF470RM3J, DDF470RMJ, DDF470RMJ1, DDF470ZJ, DDF480RF3J, DDF480RFJ, DDF480RM3J, DDF480RMJ, DDF480RTJ, DDF480Y1J, DDF480ZJ, DDF481RFJ, DDF481RMJ, DDF481RTJ, DDF481Y1J, DDF481ZJ, DDF482RM3J, DDF482RMJ, DDF482Y1J, DDF482ZJ, DHP441RFJ, DHP441ZJ, DHP444RFJ, DHP446RFJ, DHP446RMJ, DHP446ZJ, DHP448RF3J, DHP448RFJ, DHP448RM3J, DHP448RMJ, DHP448Y1J, DHP448ZJ, DHP451RFJ, DHP451RMJ, DHP451RTJ, DHP451Y1J, DHP451ZJ, DHP453RFJ, DHP453RYLJ, DHP453SHLJ, DHP454RF3J, DHP454RFJ, DHP456RF3J, DHP456RFJ, DHP456RMJ, DHP456SP1J, DHP456ZJ, DHP458RF3J, DHP458RFJ, DHP458RM3J, DHP458RMJ, DHP458RTJ, DHP458Y1J, DHP458ZJ, DHP459RF3J, DHP459RFJ, DHP459RM3J, DHP459RMJ, DHP459RTJ, DHP459Y1J, DHP459ZJ, DHP470RFJ, DHP470RMJ, DHP470ZJ, DHP480RFJ, DHP480RMJ, DHP480RTJ, DHP480ZJ, DHP481RFJ, DHP481RMJ, DHP481Y1J, DHP481ZJ, DHP482RMJ, DHP482ZJ, DLX2019JX1, DLX2117MJ, DLX2126TJ1, DLX2130TJ3, DLX2152TJ1, DHP485Z, DHP485RTJ, DHP485SFE, DHP485SME, DDF485Z, DDF485RTJ	Plastic
837920-3	GA5030JSP1	Plastic
838024-4	6906J	Plastic
838025-2	9046J	Plastic
838028-6	BO3711J	Plastic
838029-4	BO4555J, BO4558J, BO4565J, BO4566J	Plastic
838040-6	DDA340RFJ, DDA340RMJ, DDA340Y1J, DDA340ZJ, DDA341RFJ, DDA341RMJ, DDA341Y1J, DDA341ZJ, DDA350RFJ, DDA350RMJ, DDA350RTJ, DDA350Y1J, DDA350ZJ, DDA351RFJ, DDA351RMJ, DDA351RTJ, DDA351Y1J, DDA351Z	Plastic
838119-3	DFS450RMJ, DFS450Y1J	Plastic
838214-9	6271DWPX3	Plastic
838267-8	DF347DWJX4	Plastic
838302-2	DJS130RMJ, DJS130RTJ	Plastic
838315-3	HS301DSAJ, HS301DSMJ, HS301DY1J	Plastic
838550-3	DTW190RFJ, DTW190RMJ, DTW190RTJ, DTW190ZJ	Plastic
838582-0	DST111RFJ, DST111ZJ, DST112RFJ, DST112ZJ	Plastic
838612-7	TM30DSAJX3, TM30DSAJX4, TM30DSMJX5, TM30DZJX5	Plastic
839245-1	HR140DWAE1	Plastic
TYPE 4 821552-6		
837247-1	RT0700CJ, RT0700CX2J, RT0700CX3J, RT0700CX5J	Material
837635-2	DHS630RFJ, DHS630RMJ, DHS630RTJ, DHS630Y1J, DHS630ZJ	Plastic
837647-5	RP1800FX1J, RP1800FXJ, RP1800X1J, RP1800XJ, RP2300FC3J, RP2300FCXJ, RP2300FCX1J	Plastic
837649-1	DHR242RFJ, DHR242RMJ, DHR242RTJ, DHR242ZJ, DHR243RFJ, DHR243RMJ, DHR243RTJ, DHR243Y1J, DHR243ZJ,	Plastic
837650-6	BHR262RDJ, BHR262TDPJ, BHR262TRDJ, BHR262TZJ	Plastic
837657-2	5008MGJ, 5008MGJX, 5604RJ	Plastic
837787-9	DK1479J, DLX3001J	Plastic
837807-9	5704RJ, HS6101J, HS6101J1, HS7101J, HS7101J1, HS7101JX	Plastic
837861-3	DHS710PM2J, DHS710PT2J, DHS710RF2J, DHS710RM2J, DHS710RT2J, DHS710ZJ	Plastic
837873-6	N5900BJ	Plastic
837894-8	4131J	Plastic
837988-9	DHR263ZJ, DHR264RM2J, DHR264ZJ	Plastic
838096-9	DLX2053ZJ, DLX2125ZJ	Plastic
838108-8	HS7601J	Plastic
838111-9	SG1251J,	Plastic
838253-9	DLX2067PMJ, DLX2067PTJ, DLX2106PMJ	Plastic
838257-1	DHR264PM2J, DHR264PT2J	Plastic
838390-9	CA5000XJ	Plastic
838538-3	GA5040CJD1	Plastic
839523-9	DBN600ZJ	Plastic
839559-8	DHR280ZJ, DHR281ZJ	Plastic
839290-6	DSP601ZJU, DSP601ZJ	Plastic
839891-0	DHR182ZJ	Plastic

Batteries & Cases
Tool Holders
Drilling
Fixing
Saw Blades
Jigsaw & Recip
Multi Tool
Diamond
Bonded Abrasives
Flap Discs
Coated Abrasives
Router Cutters
Dust Extraction
Ground Maintenance

Belts and Pouches - Blue Collection

The Blue Collection tool holders and pouches are designed and manufactured in Europe, are both innovative and stylish. With over 50 designs using the highest quality materials they are technically advanced with comfort and safety being important features. Air-mesh material allowing circulation of air for the wearer, and high-visibility reflective inlays have been incorporated into the design. All metal parts including the riveted seams are manufactured from stainless steel parts ensuring extended durability and extra security when holding heavy items. The range now covers, Tool Holders, Pouches, Belts, Forestry, and a new collection of Bags and Holdalls.



LEATHER BELT - BROWN M 28" - 38" P-72229

Fits waist sizes 28"- 38". Made from top grain leather, Makita logo is embossed into fashionable, age distressed buckle.	Height	38mm
	Width	-
	Length	1130mm
	Weight	0.2kg
	Capacity	-

LEATHER BELT - BROWN L 33" - 45" P-72235

Fits waist sizes 33"- 45". Made from top grain leather, Makita logo is embossed into fashionable, age distressed buckle.	Height	38mm
	Width	-
	Length	1330mm
	Weight	0.2kg
	Capacity	-

LEATHER BELT - BLACK M 28" - 38" P-72207

Fits waist sizes 28"- 38". Made from top grain leather, Makita logo is embossed into fashionable, age distressed buckle.	Height	38mm
	Width	-
	Length	1130mm
	Weight	0.2kg
	Capacity	-

LEATHER BELT - BLACK L 33" - 45" P-72213

Fits waist sizes 33"- 45". Made from top grain leather, Makita logo is embossed into fashionable, age distressed buckle.	Height	38mm
	Width	-
	Length	1330mm
	Weight	0.2kg
	Capacity	-

TOOL BELT SYSTEM: BLUE COLLECTION

"HEAVYWEIGHT" LEATHER BELT

P-71803

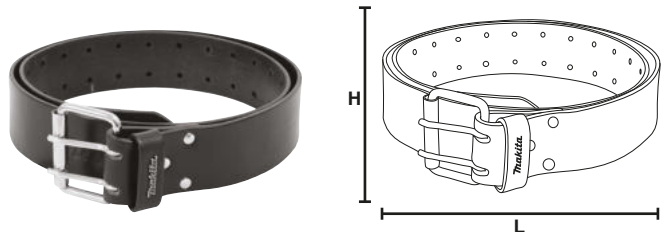

This hard wearing premium leather belt is an ideal start to your customised tool belt system. Fits up to 48" waist.

Height	48mm
Width	-
Length	380mm
Weight	0.29kg
Capacity	-

HEAVY DUTY BELT

P-80911

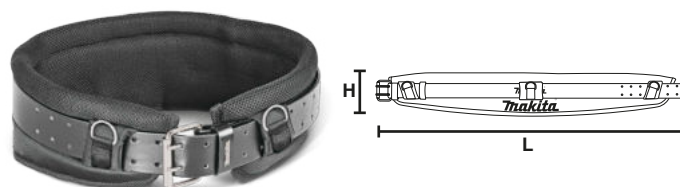

Extra-cushioned construction provides perfect foundation for building a customised tool belt set. The Belt fits any Pouch or Holder as well as Tool Organiser.

Height	130mm
Width	-
Length	940mm
Weight	0.51kg
Capacity	-

QUICK RELEASE BELT

P-71825

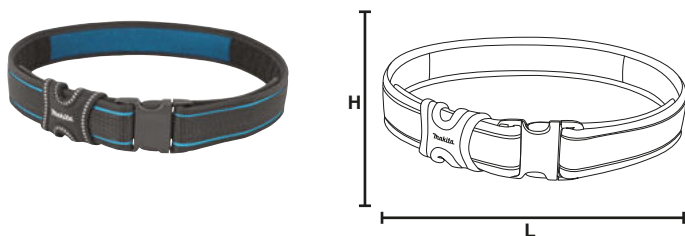

With the quick release belt it doesn't matter what your size as the belt is easily adjustable. Fits any Makita pouch or holster.

Height	50mm
Width	-
Length	1340mm
Weight	0.23kg
Capacity	-

QUICK RELEASE SHOULDER STRAP / TOOL BELT

P-81000

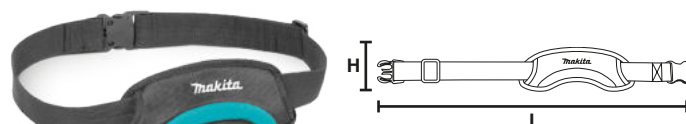

Quick release buckle system ensures easy fastening and unfastening. The length is adjustable to different waist sizes. This light duty tool belt fits any pouch or holder from the collection.

Height	100mm
Width	15mm
Length	1,320mm
Weight	0.13kg
Capacity	-

UNIVERSAL BAG AND BELT SET

P-80905

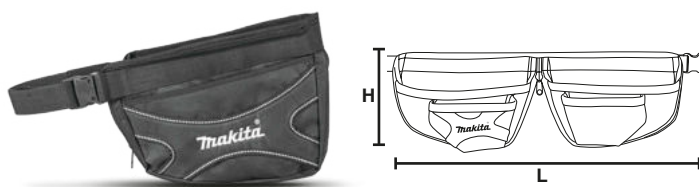

Unique construction allows for using the tool holder in two ways: as a belt set with pockets worn on the waist, or as a zipped bag with carry handle.

Height	240mm
Width	100mm
Length	350mm
Weight	0.62kg
Capacity	4.50l

"SUPER-HEAVYWEIGHT" BELT

P-71819

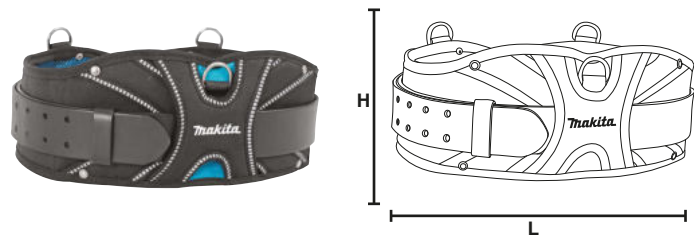

The super heavyweight belt comfy and padded. Fits any Makita tool holder or pouch. The perfect foundation for customising your tool holder set.

Height	140mm
Width	-
Length	865mm
Weight	0.62kg
Capacity	-

3 POUCH BELT SET

P-71772

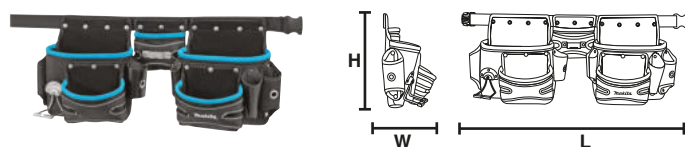

The 3 pouch belt set is a professional solution for hard working carpenters and builders.

Height	290mm
Width	170mm
Length	640mm
Weight	1.4kg
Capacity	6.0l

HEAVY DUTY BELT SET

P-80927

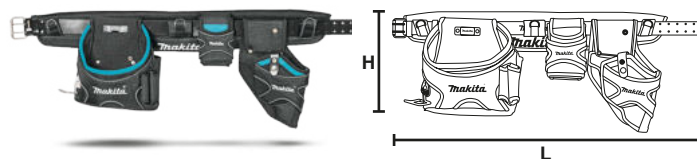

Comprises of a Heavy-Duty Belt, a Universal Pouch, a Smart Phone Holder and a Drill Holster RH. A universal set to hold all necessary tools and accessories, such as a cordless drill, a hammer, screwdrivers, hand tools, a tape measure, fixings and nails. Waist size: 30-44"

Height	300mm
Width	150mm
Length	920mm
Weight	1.37kg
Capacity	3.70l

Batteries & Cases
Tool Holders
Drilling
Fixing
Saw Blades
Jigsaw & Recip
Multi Tool
Diamond
Bonded Abrasives
Flap Discs
Coated Abrasives
Router Cutters
Dust Extraction
Ground Maintenance

TOOL BELT SYSTEM: BLUE COLLECTION

“SUPER-HEAVYWEIGHT” CHAMPION BELT SET

P-71897

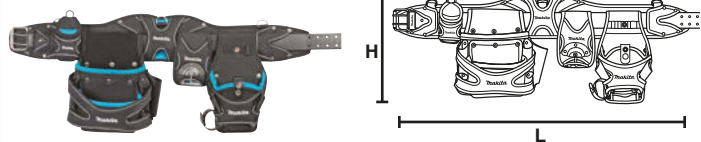

The Ultimate tool belt system!
Drill holster, fixing pouch, hammer holder, mobile phone holder with padded heavy duty belt. Waist size: 29-46"

Height	340mm
Width	-
Length	865mm
Weight	1.58kg
Capacity	2.7l

SUPER-HEAVYWEIGHT SUPPORT BRACES

P-80612

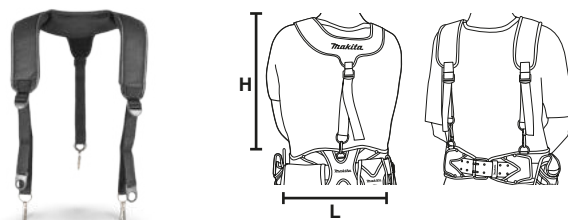

Provides added support for Super-Heavyweight tool belt and set by distributing weight between waist and shoulders. Extra thick cushioning on back and shoulder pads for maximum comfort.

Height	410mm
Width	-
Length	540mm
Weight	0.37kg
Capacity	-

PENCIL DRIVER HOLSTER

P-80999

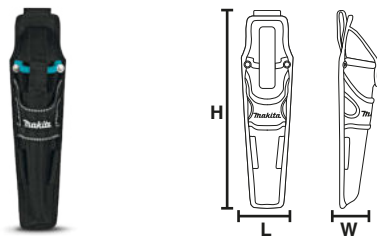

Designed to hold cordless power tool model: DF010D. Suitable for right and left-handed users. Hook-and-loop security strap ensures safe climbing of ladders and scaffolding. Two small loops on the sides for replacement screwdriver bits.

Height	320mm
Width	50mm
Length	80mm
Weight	0.12kg
Capacity	0.25l

SIDE GATE HAMMER HOLDER

P-71875

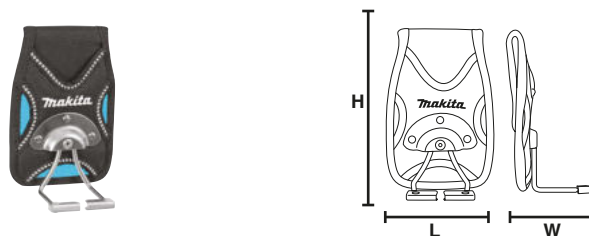

The side gate hammer holder swings to keep your hammer at a comfortable angle and also lets you put the tool in the holder without looking!

Height	160mm
Width	75mm
Length	105mm
Weight	0.14kg
Capacity	-

HAMMER HOLDER

P-71869

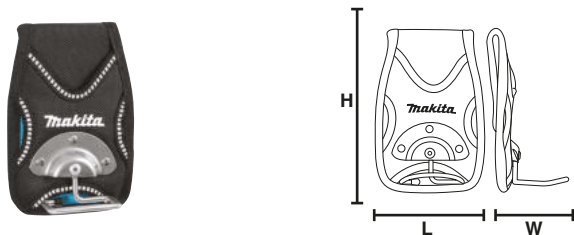

The hammer holder sits comfortably on any Makita tool belt or normal clothing belt.

Height	160mm
Width	70mm
Length	105mm
Weight	0.12kg
Capacity	-

DRILL HOLSTER R/H

P-80880

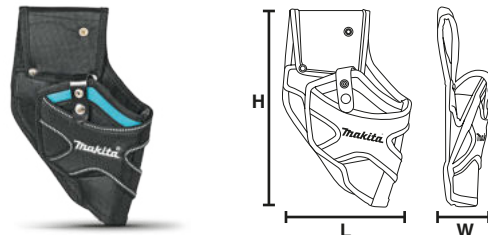

Holds any standard sized cordless or mains powered drill.

Height	320mm
Width	100mm
Length	200mm
Weight	0.25kg
Capacity	-

KNIFE AND TOOL HOLDER

P-71928

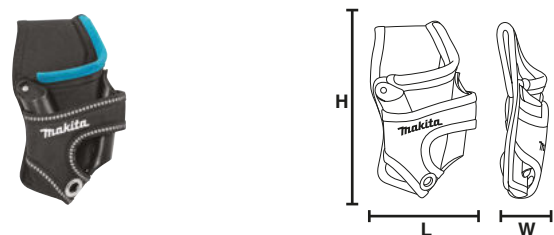

Perfectly shaped to hold a utility knife. Metal ring at the bottom keeps sharp ends away from wearers body and includes a versatile tool loop.

Height	265mm
Width	135mm
Length	260mm
Weight	0.53kg
Capacity	2.6l

MEASURING TAPE HOLDER 3-10M

P-71831

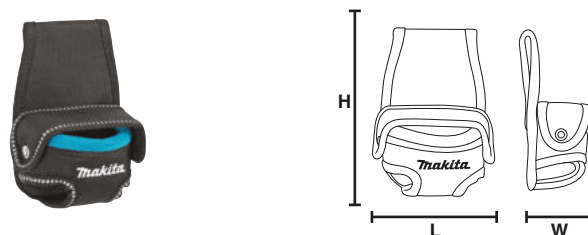

Measuring tape holder suitable for any common builders tape measure from 3-10 meters. Cover to protect tape from falling out whilst climbing ladders.

Height	165mm
Width	75mm
Length	120mm
Weight	0.1kg
Capacity	-

TOOL BELT SYSTEM: BLUE COLLECTION

IMPACT DRIVER HOLSTER UNIVERSAL L/R HANDED P-71940

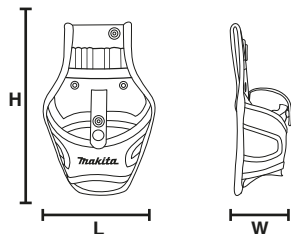

Bit loops for convenient storage, security strap to keep the driver secure when climbing ladders and scaffolding. Unique left/right handed design.

Height	235mm
Width	75mm
Length	155mm
Weight	0.13kg
Capacity	-

DRILL HOLSTER UNIVERSAL L/R HANDED P-71794

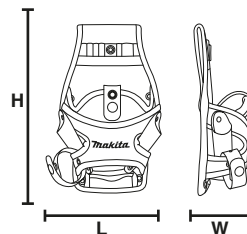

This holster is designed for the cordless and corded tools. Can be worn left or right handed with tool forward or backwards facing.

Height	290mm
Width	85mm
Length	170mm
Weight	0.26kg
Capacity	-

UNIVERSAL TOOL HOLDER P-71912

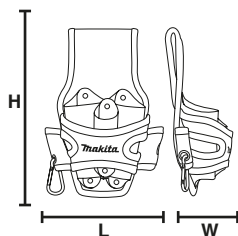

One special slot for long thin tools, two universal tool loops to hold your bigger tools and two open ended slots either side.

Height	235mm
Width	70mm
Length	175mm
Weight	0.22kg
Capacity	-

HAMMER AND TOOL HOLDER P-71934

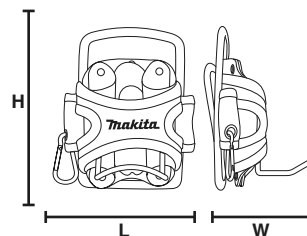

Can be worn on a belt or in pocket, so that the contents are always kept upright.

Height	325mm
Width	175mm
Length	315mm
Weight	0.76kg
Capacity	3.9l

FIXINGS POUCH AND HAMMER HOLDER P-71906

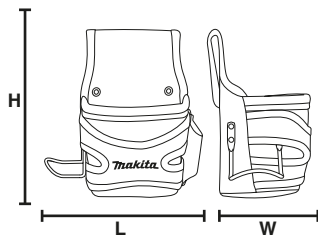

The square shaped support keeps the pouch stable and upright to prevent any danger of spilling fixings.

Height	210mm
Width	110mm
Length	180mm
Weight	0.28kg
Capacity	1.1l

TOOL ORGANISER P-80868

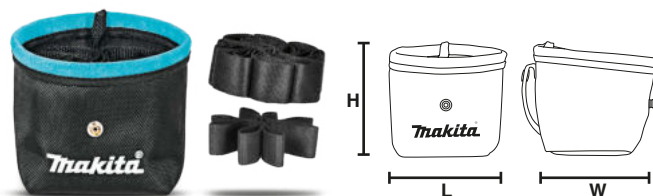

Unique but simple construction of the tool organiser makes it very functional and quick and easy to use.

Height	120mm
Width	100mm
Length	120mm
Weight	0.34kg
Capacity	1.40l

DRAWSTRING FIXINGS POUCH P-80874

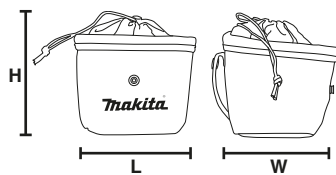

Wide and deep pouch perfect for storing large quantities of fixings, nails and other small components. Features an extending collar with a useful drawstring fastener and stopper, which prevents the content from falling out and provides quick and easy access to the inside.

Height	120mm
Width	100mm
Length	120mm
Weight	0.13kg
Capacity	1.40l

DRAWSTRING FIXINGS POUCH P-71956

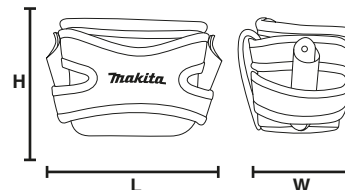

Perfect when up scaffolding and in need of plenty of fixings at hand. Extending collar and drawstring fastening make for easy access.

Height	160mm
Width	50mm
Length	155mm
Weight	0.26kg
Capacity	-

TOOL BELT SYSTEM: BLUE COLLECTION

ZIP TOP POUCH

P-71962

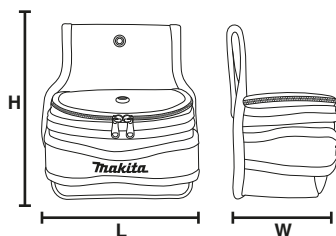

Zip allows security for important items such as keys, money or mobile phone. Additional button option to clip open pouch flap for easy access.

Height	315mm
Width	140mm
Length	250mm
Weight	0.5kg
Capacity	1.65l

UNIVERSAL POUCH

P-80933

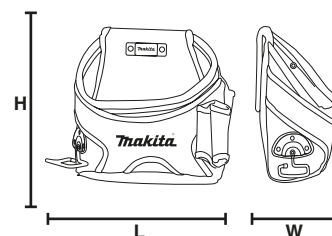

Designed to maintain a vertical position thanks to unique shape and rigid construction. A perfectly positioned and deep main pocket for all necessary tools and accessories.

Height	270mm
Width	120mm
Length	300mm
Weight	0.48kg
Capacity	3.50l

ELECTRICIANS' POUCH

P-71738

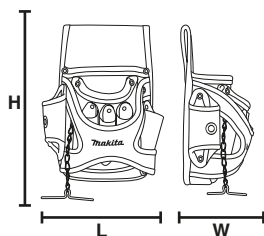

Electricians pouch is ready to carry a full range of specialised electrical tools. Designed for screwdrivers and pliers with handy insulation tape holder.

Height	315mm
Width	140mm
Length	250mm
Weight	0.5kg
Capacity	1.65l

ELECTRICIANS' MATE

P-71881

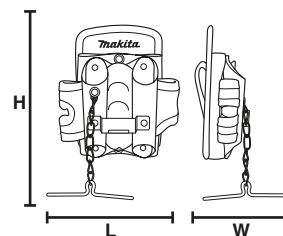

Electricians' mate holder can be adjusted to a vertical position so which ever way you wear it, it will always be comfortable. For belt or pocket flap.

Height	160mm
Width	50mm
Length	155mm
Weight	0.26kg
Capacity	-

2 POCKET FIXINGS POUCH

P-71750

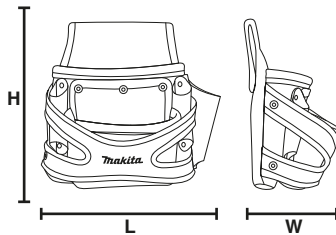

2 pocket fixings pouch has perfectly positioned wide pockets to provide quick tool recognition and easy access. For belt or use carry handle.

Height	265mm
Width	135mm
Length	260mm
Weight	0.53kg
Capacity	2.6l

3 POCKET FIXINGS POUCH

P-71766

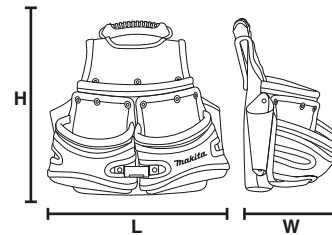

Hard wearing leather lined 3 pocket fixing pouch. Perfect for those whom need to carry different fixings and keep them separate.

Height	325mm
Width	175mm
Length	315mm
Weight	0.76kg
Capacity	3.9l

ROOFER'S POUCH

P-71788

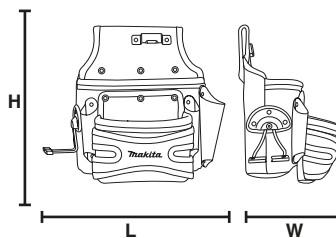

The roofers pouch has been designed specifically to keep vertical at all times to prevent spillage of fixings when pouch is full.

Height	270mm
Width	155mm
Length	265mm
Weight	0.65kg
Capacity	2.9l

GENERAL PURPOSE POUCH

P-71744

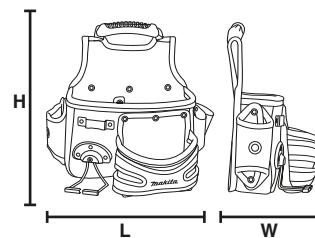

General purpose pouch has a divided 2 section main compartment. Easy carry handle for off belt use.

Height	320mm
Width	170mm
Length	350mm
Weight	0.72kg
Capacity	3.15l

TOOL BELT SYSTEM: BLUE COLLECTION

DRILL HOLSTER AND POUCH UNIVERSAL L/R HANDED P-71722

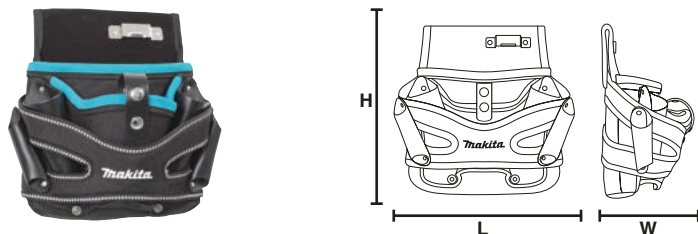

Universal drill holster and pouch lets you have all the great features of our drill holster plus a big deep pouch for all your fixings.

Height	280mm
Width	160mm
Length	255mm
Weight	0.58kg
Capacity	1.50l

SMART PHONE HOLDER P-80896

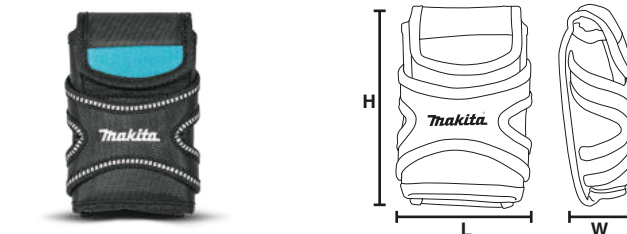

Universal size of the holder fits most popular mobile phones as well as smartphones models.

Height	150mm
Width	25mm
Length	100mm
Weight	0.09kg
Capacity	0.10l

MOBILE PHONE AND PEN HOLDER P-71847

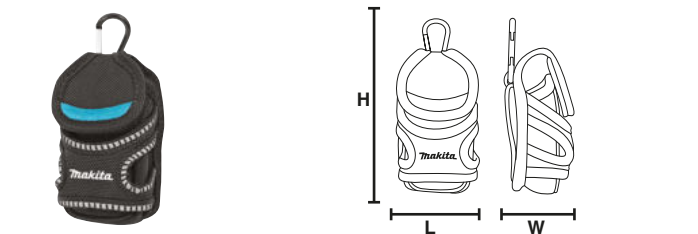

The mobile phone and pen holder sits comfortably on any Makita tool belt or normal clothing belt. Spring clip for keys or other tools.

Height	115mm
Width	40mm
Length	70mm
Weight	0.06kg
Capacity	0.09l

LARGE HOLDER - MOBILE PHONE, PDA, CAMERA P-71853

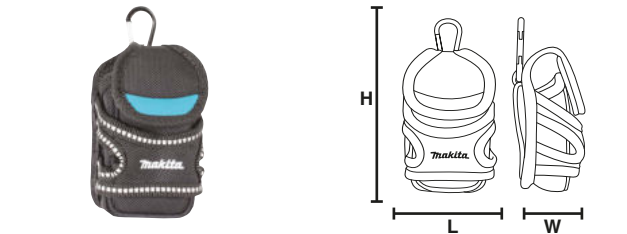

Universal size to fit most handheld PAD, camera and large mobile phone models. Can be worn on belt or hung with spring clip.

Height	125mm
Width	45mm
Length	75mm
Weight	0.07kg
Capacity	0.12l

KNEE PADS - LIGHT DUTY - INTERNAL USE P-71984



Flexible, lightweight knee pads made from durable, high quality artificial leather. Ideal for most applications.

Height	210mm
Width	50mm
Length	175mm
Weight	0.18kg
Capacity	-

GEL KNEE PADS - HEAVY DUTY - EXTERNAL USE P-71978

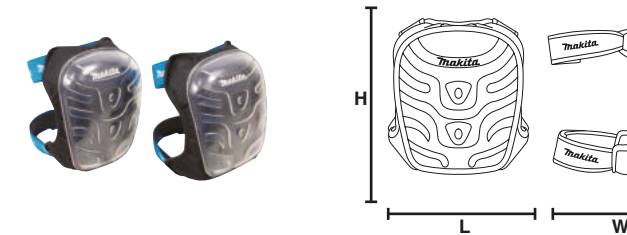

Designed for maximum protection. "U" shaped foam construction and 100% pure gel insert for better stability and comfort.

Height	210mm
Width	90mm
Length	165mm
Weight	0.49kg
Capacity	-

STAINLESS STEEL INSULATED MUG P-72198

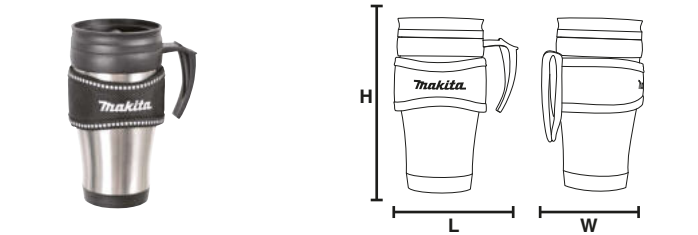

Engraved with the Makita logo, the mug keeps drinks hot or cold for many hours. Loop holder to wear on your belt.

Height	170mm
Width	95mm
Length	125mm
Weight	0.21kg
Capacity	0.40l

THERMAL FLASK WITH HOLDER P-72148

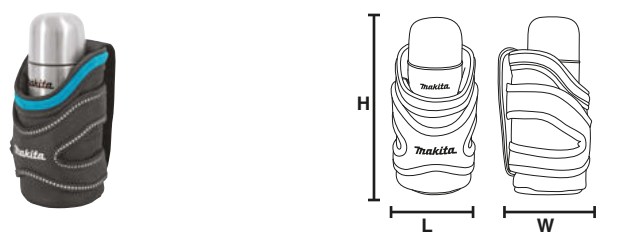

Adjustable straps and quick release buckles for ease of use. Loops allow the holster to be attached to a belt or secured to the leg with straps.

Height	215mm
Width	105mm
Length	105mm
Weight	0.42kg
Capacity	0.35l

Batteries & Cases
Tool Holders
Drilling
Fixing
Saw Blades
Jigsaw & Recip
Multi Tool
Diamond
Bonded Abrasives
Flap Discs
Coated Abrasives
Router Cutters
Dust Extraction
Ground Maintenance

TOOL BELT SYSTEM: BLUE COLLECTION

LUNCH BAG

P-72023

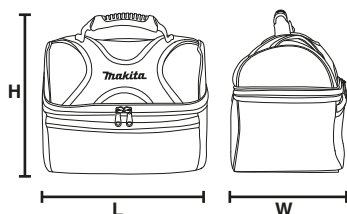

Internal aluminium foil is easy to clean and helps keep your food fresh. Can be used in conjunction with an ice pack.

Height	230mm
Width	170mm
Length	280mm
Weight	0.36kg
Capacity	7.5l

WORKERS VEST

P-72089

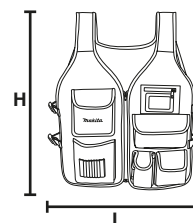

Hi-VIS trimming makes you easily visible in darkness. Many useful pockets for small tools and bits. Adjustable sides.

Height	640mm
Width	-
Length	500mm
Weight	0.74kg
Capacity	-

UNIVERSAL TOTE

P-72045

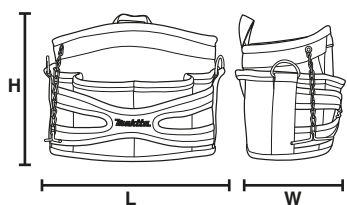

Ergonomic design adapted to the body shape. Open design for quick tool recognition with a diverse range of pocket sizes.

Height	220mm
Width	185mm
Length	290mm
Weight	0.95kg
Capacity	6.1l

BUCKET TOTE

P-72095

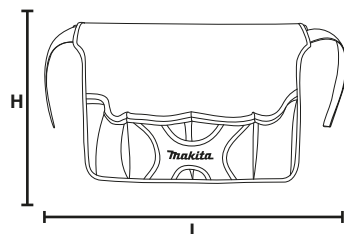

This bucket tote is adjustable so it's right for all different shapes and sizes. Bucket not included.

Height	320mm
Width	-
Length	470mm
Weight	0.38kg
Capacity	2.6l

PROFESSIONAL LAPTOP AND TOOL BAG

P-72067

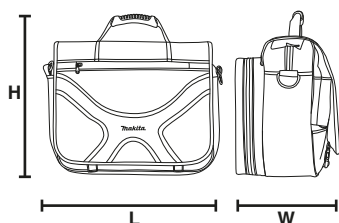

Everything a laptop bag should be. Main compartment has 2 extra pockets for mouse and charger. Extra space included for storage of CD's, pens etc.

Height	340mm
Width	225mm
Length	410mm
Weight	1.73kg
Capacity	21.0l

PROFESSIONAL TOOL RUCKSACK WITH ORGANIZER

P-72017

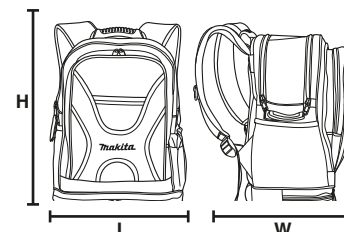

Great alternative to the classic tool bag. With plenty of space and protection for all your essential hand tools, power tools and accessories.

Height	410mm
Width	240mm
Length	295mm
Weight	1.73kg
Capacity	19.6l

TOOL BAG GATE MOUTH 20"

P-71990

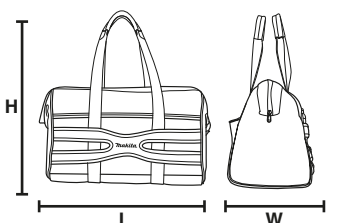

Wide mouth zip opening provides easy tool access. External straps for extra reinforcement guarantees unbreakable strength.

Height	290mm
Width	250mm
Length	520mm
Weight	1.82kg
Capacity	25.0l

TOOL CASE OPEN TOTE

P-72001

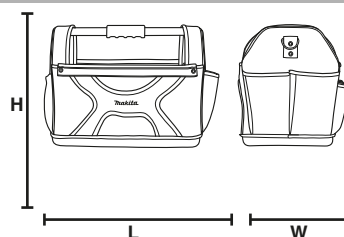

This open tote is perfect for quick and easy tool location. Internal and external pockets with elasticated side pocket to prevent small items falling out.

Height	335mm
Width	285mm
Length	450mm
Weight	2.3kg
Capacity	26.2l

TOOL BELT SYSTEM: BLUE COLLECTION

TOOL WRAP WITH HANDLE

P-72039

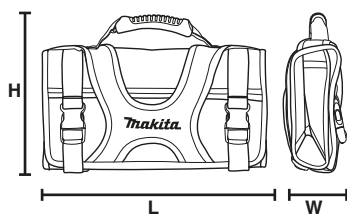

Designed to store all of your small tools and parts that seemingly get lost at the bottom of the bag.

Height	195mm
Width	85mm
Length	350mm
Weight	0.78kg
Capacity	2.2l

TOOL CASE TUBE

P-72051

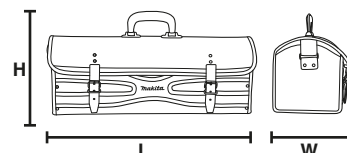

Perfect for storing long tools. Carry handle is a simple alternative to carrying the bag on your shoulder.

Height	185mm
Width	170mm
Length	515mm
Weight	1.51kg
Capacity	11.3l

TOOL CASE

P-72073

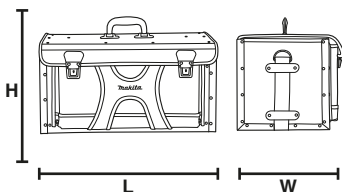

The huge tool case will carry all your tools and accessories onto the job, meaning you don't have to return to your vehicle for anything else.

Height	265mm
Width	295mm
Length	505mm
Weight	3.9kg
Capacity	32.9l

INDUSTRIAL TOOL CASE

P-80955



Giant, rigid case perfect for carrying lots of tools and accessories together.

Height	310mm
Width	300mm
Length	510mm
Weight	2.78kg
Capacity	27.00l

TOOL BAG

P-80977

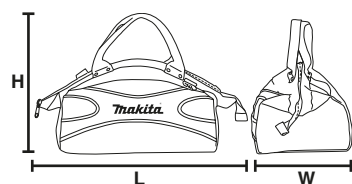

Uniquely designed, rigid gate-mouth opening with zip provides maximum access to the inside. Spacious main compartment holds a remarkable quantity of tools and power tools.

Height	300mm
Width	300mm
Length	500mm
Weight	1.93kg
Capacity	25l

TOOL CASE WING OPENING TOTE

P-80949

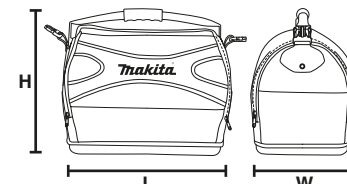

Unique construction of the case's covers with two-sided wide 'wing' opening. The covers protect tools from dirt and water and ensures the contents remains secure. When opened wide, easy access is offered to the tools and accessories.

Height	400mm
Width	290mm
Length	510mm
Weight	2.44kg
Capacity	20.70l

TOOL CASE OPEN TOTE WITH SAW POCKET

P-79946

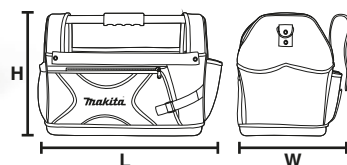

Large number of internal pockets and dedicated tool holders provide ideal storage solution for different kinds of tools and accessories.

Height	350mm
Width	340mm
Length	500mm
Weight	2.67kg
Capacity	30.00l

CHAIR TOOL BAG

P-80961

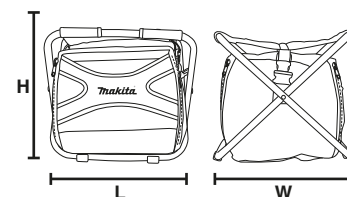

New unique solution - A Tool Bag and a Chair in one! The bag can be un-clipped and the two items can be used separately.

Height	350mm
Width	360mm
Length	400mm
Weight	4.38kg
Capacity	34l

Batteries & Cases
Tool Holders
Drilling
Fixing
Saw Blades
Jigsaw & Recip
Multi Tool
Diamond
Bonded Abrasives
Flap Discs
Coated Abrasives
Router Cutters
Dust Extraction
Ground Maintenance

TOOL BELT SYSTEM: BLUE COLLECTION FOR GROUNDS MAINTENANCE AND LANDSCAPING

UNIVERSAL GARDEN AND FOREST POUCH P-72154

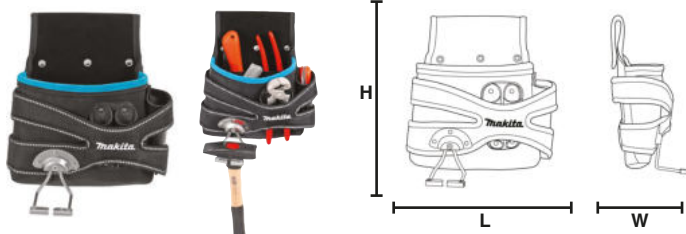

Perfectly positioned open deep pocket holds plenty of fixings and provides quick tool recognition. Rubber bands stitched to the back side of the main pocket organize tools and keep them in right places. Perfect for wedges. Side-Gate metal tool holder and versatile leather slots. Features a leather-lined interior for protection against sharp fixings.

Height	275mm
Width	105mm
Length	225mm
Weight	0.49kg
Capacity	1.30l

MULTI-PURPOSE GARDEN HOLDER P-72110

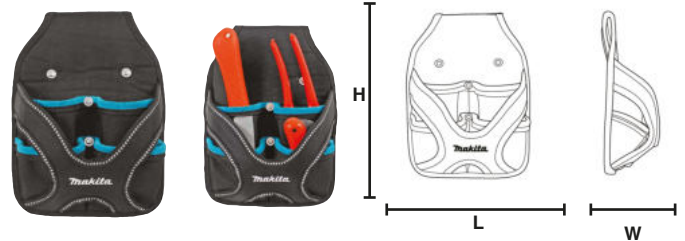

Multipurpose – four universal pockets in two sizes. Extra leather layer in hard wearing areas ensuring resistance to years of wear and tear. Perfectly positioned four open pockets provide quick tool location and for easy use.

Height	245mm
Width	80mm
Length	190mm
Weight	0.20kg
Capacity	0.60l

PROFESSIONAL SHEAR HOLSTER P-72182

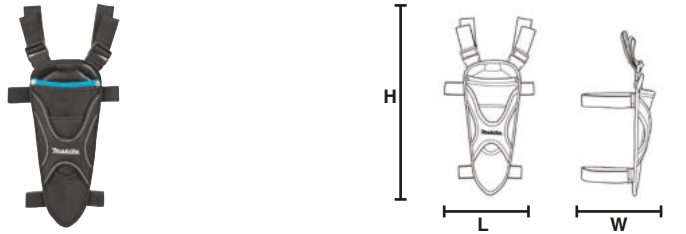

Adjustable straps and plastic quick release buckles for easy unfastening. Pocket on the front side for easy access to smaller tools. PVC coated polyester fabrics for longer life. Loops tool belt or normal clothing belt. Made from strong 35mm width elastic rubber straps that are easy to attach.

Height	370mm
Width	95mm
Length	160mm
Weight	0.37kg
Capacity	0.60l

SECATEUR AND PRUNING SAW HOLDER P-72104



Riveted in critical point for truly unbreakable strength with galvanized washers top and bottom. Extra leather layer in hard wearing areas, ensuring resistance to years of wear and tear. The pouch sits comfortably on any Makita tool belt or normal clothing belt. Special shape designed to be universal for both secateurs and folding pruning saw.

Height	270mm
Width	55mm
Length	130mm
Weight	0.10kg
Capacity	0.20l

CALLIPER AND AXE HOLDER P-72126

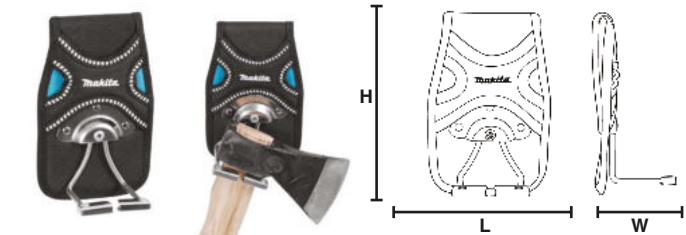

Side-Gate Caliper & Axe metal holder swivels to keep a tool at a comfortable angle. New solution with side gate lets you hang the tool without looking at a holder. The holder sits comfortable on any Makita tool belt or normal clothing belt. Riveted with galvanized washers top and bottom.

Height	170mm
Width	65mm
Length	120mm
Weight	0.12kg
Capacity	-

CHAINSAW AND FOREST TOOL HOLDER P-72132

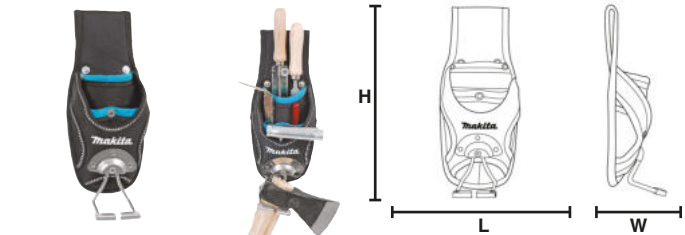

Extra leather layer in friction points help protect against years of wear and tear. Elasticated Band keeps thin tools secure and upright to prevent them falling out. Three versatile pockets and open design provides easy access to tools. Side-Gate Calliper & Axe metal holder swivels to keep a tool at a comfortable angle. Side gate lets you easily put the tool in without looking at the holder.

Height	280mm
Width	70mm
Length	115mm
Weight	0.25kg
Capacity	0.25l

PROFESSIONAL FORESTRY TOOL BAR P-72160



Open design provides easy access. Pockets for two wedges and marking pens. Three leather holders provide convenient tool storage. Flapped pocket with clip for First Aid Kit. Two metal rings to hang your forestry measuring tape. PVC coated polyester no tear lining to give extra strength and protect the pouch before damage (First Aid Kit not included)

Height	240mm
Width	90mm
Length	340mm
Weight	0.40kg
Capacity	0.35l

BRACES WITH CLIPS P-72176

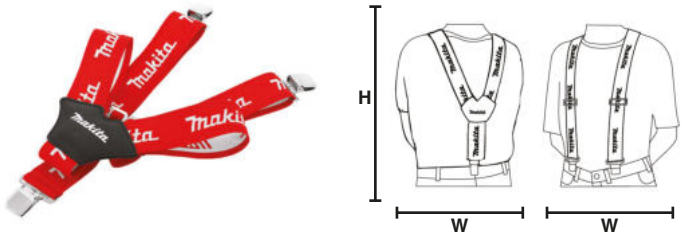

One size fits all. Designed to transfer weight from waist to shoulders. Straps with two steel buckles makes it easy to adapt the length to your body. Made of strong and durable 50 mm width elastic rubber.

Height	universal
Width	50mm
Length	-
Weight	0.23kg
Capacity	-

DRILLING: METAL

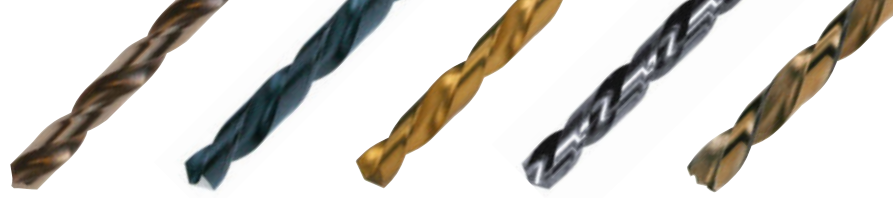

Ground Point HSS-R

Performance HSS-G

Titanium HSS-TIN

Colbalt HSS-CO

M-Force

HSS Metal Drill Bits Series

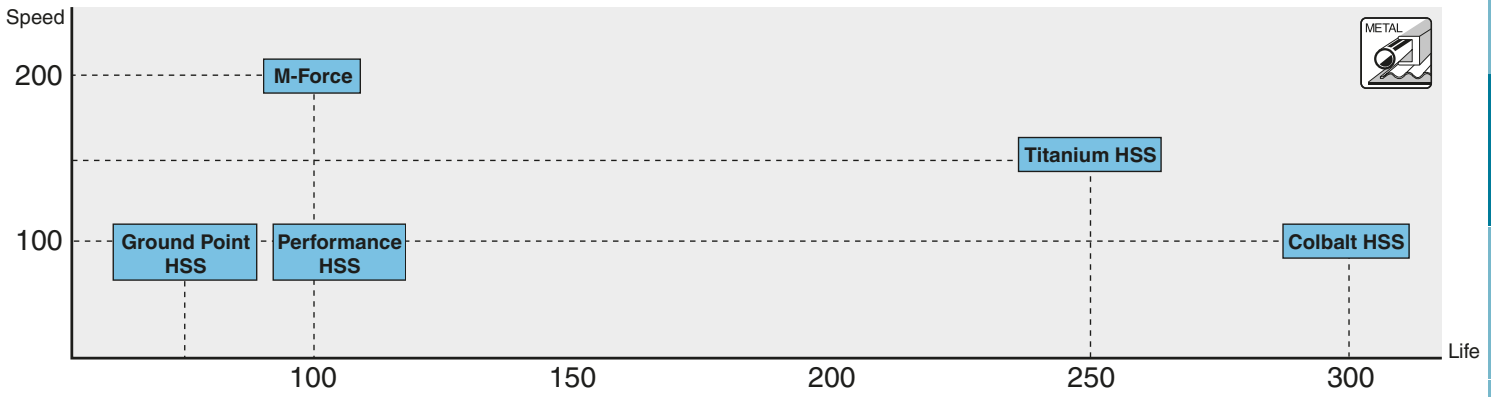

Part No.	D mm	L1 mm	L2 mm	Pack
B-38869	3.3	50	20	5
B-56437				

RIVET DRILL BIT

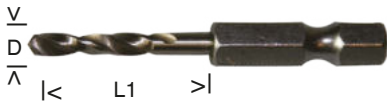

B-38869	3.3	50	20	5	*****
B-56437					

A 1/4" shank bit that's specially designed for drilling holes for rivets. The sharp cross-shaped drilling tip has a 135° split point, which means these bits will drill holes at twice the speed of a standard bit with a sharper centre point that will not wander.



GROUND POINT HSS-R

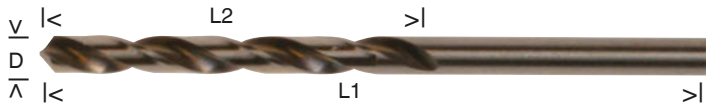

HSS Ground Point

Ground point drill bits suitable for ferrous and non-ferrous metals, offering good drilling speeds and extended working life. Available in 1.5mm - 13mm singular or in multipacks.



D-09656	1.5	40	18	1	***
D-09662	2	49	24	1	
D-09678	2.5	57	30	1	
D-09684	3	61	33	1	
D-09690	3.5	70	39	1	
D-09709	4	75	43	1	
D-09715	4.5	80	47	1	
D-09721	5	86	52	1	
D-09737	5.5	93	57	1	
D-09743	6	93	57	1	
D-09759	6.5	101	63	1	
D-09765	7	109	69	1	
D-09771	7.5	109	69	1	
D-09787	8	117	75	1	
D-09793	8.5	117	75	1	
D-09802	9	125	81	1	
D-09818	9.5	125	81	1	
D-09824	10	133	87	1	
D-09830	10.5	133	87	1	
D-09846	11	142	94	1	
D-09852	11.5	142	94	1	
D-09868	12	151	101	1	
D-09874	12.5	151	101	1	
D-09880	13	151	101	1	

GROUND POINT HSS DISPENSER

D-30617

Red Dispenser with Ground Point HSS Multi-Packs

10PC: 1.5, 2, 2.5, 3, 3.5, 4, 4.5, 5, 5.5, 6, 6.25, 6.5, 7, 7.5, 8mm

5PC: 8.5, 9, 9.5, 10, 10.5, 11, 11.5, 12, 12.5, 13mm



Batteries & Cases
Tool Holders
Drilling
Fixing
Saw Blades
Jigsaw & Recip
Multi Tool
Diamond
Bonded Abrasives
Flap Discs
Coated Abrasives
Router Cutters
Dust Extraction
Ground Maintenance

DRILLING: METAL

PERFORMANCE GROUND POINT HSS-G



Performance Ground Point straight shank

These bits have a 118° ground point for fast and accurate drilling. They are milled from a solid steel form which means a higher level of strength and precision. Ideal for use on steel, cast iron, aluminium, malleable cast iron, brass and copper aided with a helicoidal flute to improve swarf discharge.



Part No.	D mm	L1 mm	L2 mm	Pack
P-19314	2	49	24	2
P-19320	2.5	57	30	2
P-19336	2.6	57	30	2
P-19342	3	61	33	2
P-19358	3.2	65	36	2
P-19364	3.3	65	36	2
P-19370	3.5	70	39	2
P-19386	3.8	75	43	2
P-19392	4	75	43	2
P-19401	4.1	75	43	2
P-19417	4.2	75	43	2
P-19423	4.3	80	47	2
P-19439	4.5	80	47	2
P-19445	4.8	86	52	2
P-19451	5	86	52	2
P-19467	5.1	86	52	1
P-19473	5.2	86	52	1
P-19489	5.5	93	57	1
P-19495	6	93	57	1
P-19504	6.5	101	63	1
P-19510	6.8	109	69	1
P-19526	7	109	69	1
P-19532	7.5	109	69	1
P-19554	8	117	75	1
P-19560	8.5	117	75	1
P-19576	9	125	81	1
P-19582	9.5	125	81	1
P-19598	10	133	87	1
P-19607	10.5	133	87	1
P-19613	11	142	94	1
P-19629	11.5	142	94	1
P-19635	12	151	101	1
P-19641	12.5	151	101	1
P-19657	13	151	101	1

PERFORMANCE GROUND POINT HSS SET 6PC P-23743

2mm	
3mm	
4mm	
5mm	
6mm	
8mm	

PERFORMANCE GROUND POINT HSS SET 10PC P-23765

1mm	8mm	
2mm	9mm	
3mm	10mm	
4mm		
5mm		
6mm		
7mm		

PERFORMANCE GROUND POINT HSS SET 19PC P-19906

1mm	5mm	9mm	
1.5mm	5.5mm	9.5mm	
2mm	6mm	10mm	
2.5mm	6.5mm		
3mm	7mm		
3.5mm	7.5mm		
4mm	8mm		
4.5mm	8.5mm		

TITANIUM HSS HEX FITTING HSS-TIN

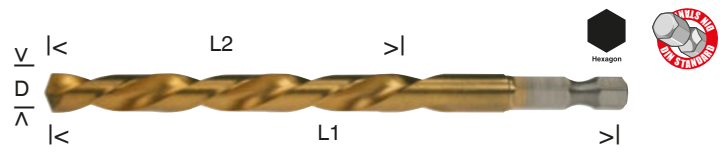

Titanium HSS

Titanium nitride coated for extended working life. 1/4" hex shank suitable for quick change chuck systems and hex receivers. Diameters from 3 - 13mm. Kits are round shank.



Part No.	D mm	L1 mm	L2 mm	Pack
D-14928	3	80	47	1
D-14934	3.2	85	52	1
D-16081	3.3	85	52	1
D-14940	4	95	57	1
D-14956	4.2	95	57	1
D-14962	5	105	65	1
D-14978	6	110	69	1
D-15827	8	115	75	1
D-15833	10	130	87	1
D-15849	12	150	101	1
D-15855	13	150	101	1

TITANIUM DRILL SET 19PC P-30813

1-10mm x 35-130mm	
-------------------	--

TITANIUM DRILL SET 16PC P-51873

1.5-10mm x 40-130mm	
---------------------	--

DRILLING: METAL

COBALT HSS-CO

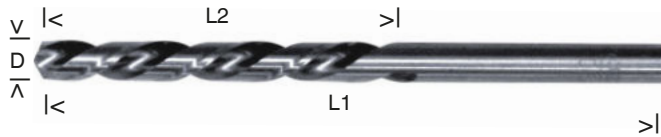

Cobalt straight shank

HSS drill bits, to DIN338 featuring M35 steel with 5% cobalt content. This means the bit is stronger and lasts longer when compared to a traditional one. A 118° point reduces the risk of the bit slipping with a high temperature treatment during the manufacturing process make it perfect when applied to steels that are tensile or have a large alloy content (like auto or aircraft bodies). Use on mild steel, stainless steel and difficult to machine materials, welded seams and car body work.



Part No.	D mm	L1 mm	L2 mm	Pack
D-17289	1.5	40	16	1
D-17295	2	49	24	1
D-17304	2.5	57	30	1
D-17310	3	61	33	1
D-17332	3.5	70	39	1
D-17348	4	75	43	1
D-17354	4.5	80	47	1
D-17360	5	86	52	1
D-17376	5.5	93	57	1
D-17382	6	93	57	1
D-22648	6.35			1
D-17398	6.5	101	63	1
D-17407	7	109	69	1
D-17413	7.5	109	69	1
D-17429	8	117	75	1
D-17435	8.5	117	75	1
D-17441	9	125	81	1
D-17457	9.5	125	81	1
D-17463	10	133	87	1
D-17479	10.5	133	89	1
D-17485	11	142	94	1
D-17491	11.5	142	94	1
D-17500	12	151	101	1
D-17516	12.5	151	101	1
D-17522	13	151	101	1

M-FORCE MULTIFACETED HSS



Multifaceted straight shank

M-Force drills with multiple cutting faces, drills quickly, requires 50% less thrust and produces 60% less heat. A self centring point that does not wander and produces a true round hole. Titanium nitride coated to help dissipate heat and ensures extended service life.



Part No.	D mm	L1 mm	L2 mm	Pack
D-29614	2	49	24	1
D-29620	2.5	57	30	1
D-29636	3	61	33	1
D-29642	3.5	70	39	1
D-29658	4	75	43	1
D-29664	4.5	80	47	1
D-29670	5	86	52	1
D-29686	5.5	93	57	1
D-29692	6	93	57	1
D-29701	6.5	101	63	1
D-29717	7	109	69	1
D-29723	7.5	109	69	1
D-29739	8	117	75	1
D-29745	8.5	117	75	1
D-29751	9	125	81	1
D-29767	9.5	125	81	1
D-29773	10	133	87	1
D-29789	10.5	133	87	1
D-29795	11	142	94	1
D-29804	11.5	142	94	1
D-29810	12	151	101	1
D-29826	12.5	151	101	1
D-29832	13	151	101	1

METAL DRILL BITS HSS-TIN SDS-PLUS SHORT SHANK

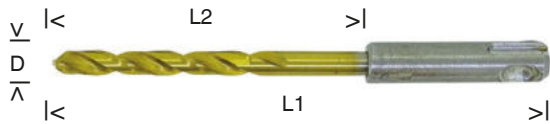

To be used in rotation only mode.

Enables SDS+ Hammers to use drills bit suitable for metal.

Standard accessory drill bits for HR166D (Comes in case)

Part No.	D mm	L1 mm	L2 mm	Pack
B-57401	3	90		1
B-57417	3.5	100		1
B-57423	4	105		1
B-57439	4.5	110		1
B-57445	5	116		1
B-57451	5.5	123		1
B-57467	6	123		1
B-57473	6.5	131		1

METAL AND WOOD DRILL BIT SET 5PC

B-57532

Metal: 3x90, 4x105mm

Wood: 4x105, 5x116, 6x123mm



Batteries & Cases
Tool Holders
Drilling
Fixing
Saw Blades
Jigsaw & Recip
Multi Tool
Diamond
Bonded Abrasives
Flap Discs
Coated Abrasives
Router Cutters
Dust Extraction
Ground Maintenance

COUNTERSINK BITS



Part No.	Length	Diameter	Shank	Application	Cutting Edge
----------	--------	----------	-------	-------------	--------------



It is made of alloy steel and economical type of bit. It can make a variety of holes up to M10 freely.

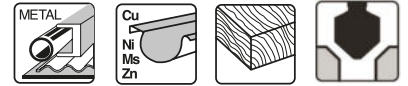

D-37306	50mm	13mm	1/4" HEX	90°	7
---------	------	------	----------	-----	---



DIN 338

Countersink with three cutters and large flutes are used for dee countersinking. The shank is in C form and can be used with a variety of bit holders.

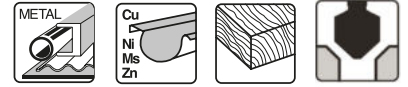

D-37312	31mm	6.3mm	1/4" C form	M3	3
D-37328	31mm	8.3mm	1/4" C form	M4	3
D-37334	34mm	10.4mm	1/4" C form	M5	3
D-37340	35mm	12.4mm	1/4" C form	M6	3
D-37356	40mm	16.5mm	1/4" C form	M8	3
D-37362	41mm	20.5mm	1/4" C form	M10	3



Straight shank. Countersink with five or more cutters are used for flat countersinking.

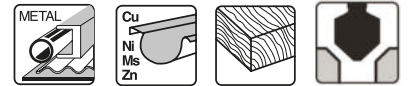

D-37378	48mm	6mm	Cylindrical 6mm	M3	5
D-37384	48mm	8mm	Cylindrical 6mm	M4	5
D-37390	40mm	10mm	Cylindrical 6mm	M5	5
D-37409	40mm	12mm	Cylindrical 6mm	M6	5
D-37415	43mm	16mm	Cylindrical 6mm	M8	5
D-37421	45mm	20mm	Cylindrical 6mm	M10	5



DIN 338

Straight shank. Countersink with three cutters and large flutes are used for deep countersinking. It is the most common type of countersink bit.

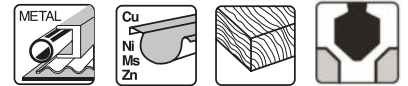

D-37437	45mm	6.3mm	Cylindrical 5mm	M3	3
D-37443	50mm	8.3mm	Cylindrical 6mm	M4	3
D-37459	50mm	10.4mm	Cylindrical 6mm	M5	3
D-37465	56mm	12.4mm	Cylindrical 8mm	M6	3
D-37471	60mm	16.5mm	Cylindrical 10mm	M8	3
D-37487	63mm	20.5mm	Cylindrical 10mm	M10	3
D-37493	67mm	25mm	Cylindrical 10mm	M12	3



Slanting hole countersinks have a conical head with a slant opening. The cutting edge is formed by the slanted opening on the cutter head. Because of the special cutting edge geometry, the filing can escape in a continuous flow which allows more stable, smooth, roundish countersinking especially in thin metal sheets.

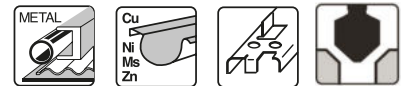

D-37502	45mm	2-5mm	Cylindrical 6mm	90°	1
D-37518	48mm	5-10mm	Cylindrical 8mm	90°	1
D-37524	65mm	10-15mm	Cylindrical 10mm	90°	1
D-37530	85mm	15-20mm	Cylindrical 12mm	90°	1

COUNTERSINK 6PC SET

D-42204

Length: 45mm - 63mm
Diameter: 6.3mm - 20.5mm
Cylindrical: 5mm - 10mm

- Straight shank
- 3 Cutters
- Deep countersinking

Applications:
M3, M4, M5, M6, M8, M10

DIN 338



COUNTERSINK 4PC SET

P-51954

Features: 4 counter sink bits
Contains: 4 - Fast Change Countersink. Size: No.6, No.8, No.10, No.12

For recessing screws in hinges and for furniture
Application: Countersink, joinery, cabinet making, furniture, assembly, MDF





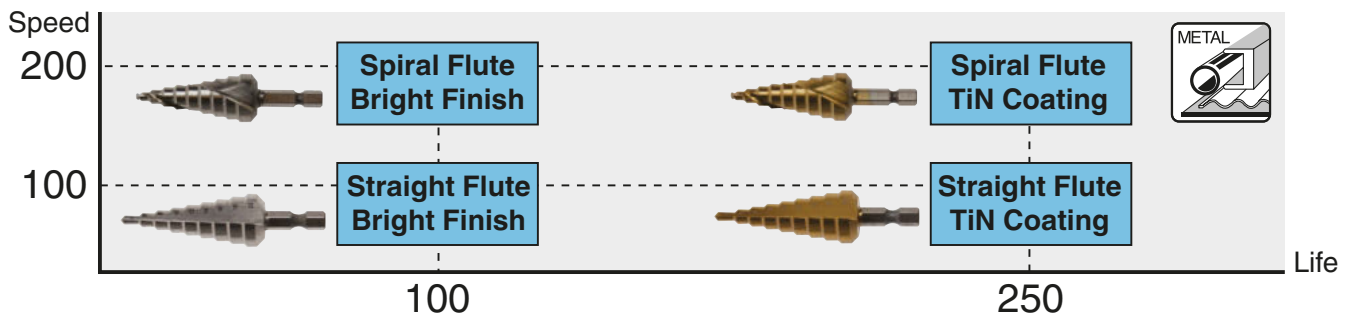





DRILLING: METAL



















CONE DRILL BITS



Part No.	Flute	Shank	Application
		HSS DIN 1412C	  
D-40048	Straight	6mm 3 Flat	3-14
D-40054	Straight	6mm 3 Flat	4-20
		HSS DIN 1412C	  
D-40060	Straight	6mm 3 Flat	16-30.5
D-40076	Straight	6mm 3 Flat	24-40

STEP DRILL BITS



		DIN 1412C	  
D-40082	Straight	1/4" HEX	4-12
D-40098	Straight	1/4" HEX	4-20
D-40107	Straight	6mm 3 Flat	4-32
		TiN Coated DIN 1412C	  
D-40113	Straight	1/4" HEX	4-12
D-40129	Straight	1/4" HEX	4-20
D-40135	Straight	6mm 3 Flat	4-32
		DIN 1412C	  
D-40141	Spiral	1/4" HEX	4-12
D-40157	Spiral	1/4" HEX	4-20
D-40163	Spiral	6mm 3 Flat	4-32
		TiN Coated DIN 1412C	  
D-40179	Spiral	1/4" HEX	4-12
D-40185	Spiral	1/4" HEX	4-20
D-40191	Spiral	6mm 3 Flat	4-32

CONE DRILL BIT SET 3PC

D-41872

- D-40179: 4-12mm
- D-40185: 4-20mm
- D-40191: 4-32mm



Batteries & Cases
Tool Holders
Drilling
Fixing
Saw Blades
Jigsaws & Recip
Multi Tool
Diamond
Bonded Abrasives
Flap Discs
Coated Abrasives
Router Cutters
Dust Extraction
Ground Maintenance

STANDARD FLAT BIT



Part No.	D mm	L1 mm	L2 mm	Pack
D-07674	6	150	125	1
D-07680	8	150	125	1
D-07696	10	150	125	1
D-07705	12	150	125	1
D-07711	14	150	125	1
D-07727	15	150	125	1
D-07733	16	150	125	1
D-07749	18	150	125	1
D-07755	20	150	125	1
D-07761	22	150	125	1
D-07777	24	150	125	1
D-07783	25	150	125	1
D-07799	26	160	130	1
D-07808	28	160	130	1
D-07814	30	160	130	1
D-07820	32	160	130	1
D-07836	34	160	130	1
D-07842	35	160	130	1
D-07858	36	160	130	1

Flat-Bit

Contractor quality flat bits, suitable for hard, soft woods and on site use. Diameters 6 - 36mm. Hex shank for high torque application.



PERFORMANCE FLAT BIT

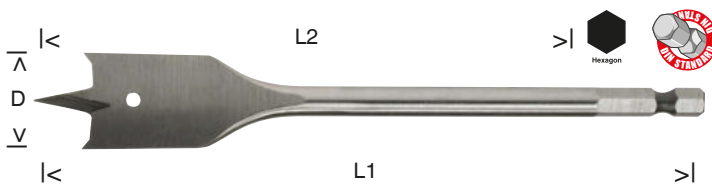

Performance Flat-Bit

Ideal for most types of wood, hard or soft. A flat-bit with a grooved head for improved centring and discharge and a hexagon shank that prevents chuck slippage. Available up to 35mm diameter and in 150mm or 300mm length.

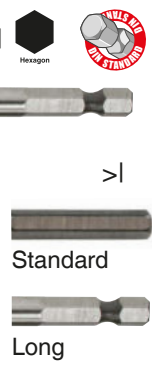

Extension Bar 7/16" hex shank

For self feed bits and auger bits 9/16" (14.2mm) in diameter and larger

STANDARD LENGTH				
P-23357	8	150	125	1
P-23363	10	150	125	1
P-30237	12	150	125	1
P-23379	14	150	125	1
P-23385	16	150	125	1
P-23391	18	150	125	1
P-30243	20	150	125	1
P-23400	22	150	125	1
P-23416	25	150	125	1
P-23422	32	150	115	1
P-63769	35	150	125	1
LONG LENGTH				
P-46143	16	300	275	1
P-46137	18	300	275	1
P-46121	22	300	275	1
P-46115	25	300	275	1
P-46109	32	300	275	1
EXTENSION BARS				
D-35645		140		1
D-35651		305		1
D-35639		457		1

FLAT BIT SET 8PC P-52093

12, 14, 16, 18, 20, 22, 25, 32 x 150mm



FLAT BIT LONG LENGTH SET 5PC P-46090

16, 18, 22, 25, 32 x 300mm



FLAT BIT SET 5PC P-46084

16, 18, 22, 25, 32 x 150mm



Part No.	D mm	L1 mm	L2 mm	Pack
----------	------	-------	-------	------

STANDARD 3 POINT WOOD BITS



3 Point Wood Bits straight shank

These bits are excellent when applied to hard or soft wood. They have a polished steel body with a centering point.



STANDARD LENGTH				
D-07026	3	60	30	1
D-07032	4	75	43	1
D-07048	5	85	50	1
D-07054	6	95	58	1
D-07060	7	110	70	1
D-07076	8	115	73	1
D-07082	9	125	80	1
D-07098	10	135	85	1
D-07107	12	155	100	1
D-53453	13	151	96	1
D-07113	14	170	120	1
D-53469	15	160	100	1
D-07129	16	180	130	1
D-07135	18	200	140	1
D-07141	20	200	140	1
LONG LENGTH				
D-07157	6	315	150	1
D-07163	8	315	150	1
D-07179	10	315	150	1
D-07185	12	315	150	1
D-07191	14	315	150	1
D-07200	16	315	150	1
D-07216	18	335	150	1
D-07222	20	335	150	1

STANDARD 3 POINT WOOD BITS HEX FITTING

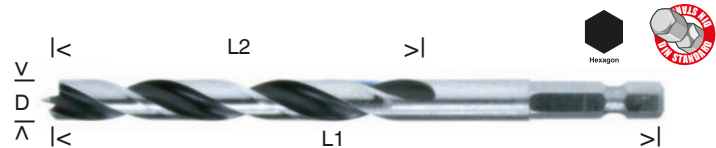

1/4" Hexagon shank bits

Suitable for drilling holes with small or medium diameter. Able to drive to drill soft plastics and general wood.



D-15861	3	60	30	1
D-15877	4	70	46	1
D-15883	5	85	50	1
D-15899	6	92	75	1
D-15908	8	115	76	1
D-15914	10	130	85	1
D-15920	12	150	95	1
D-15936	15	150	100	1

WOOD DRILL BITS SDS-PLUS SHORT SHANK



To be used in rotation only mode.

Enables SDS+ Hammers to use drills bit suitable for wood.

Standard accessory drill bits for HR166D (Comes in case)

B-57489	4	105		1
B-57495	5	116		1
B-57504	6	123		1
B-57510	8	147		1
B-57526	10	163		1

METAL AND WOOD DRILL BIT SET 5PC

B-57532

Metal: 3x90, 4x105mm

Wood: 4x105, 5x116, 6x123mm



FORSTNER BITS



TOOTH TYPE
10 - 20 Flat Tooth
25+ Saw Tooth

Suitable for drilling blind holes or penetrating holes of medium to large diameter with a high quality finish.



D-41844	10	90	8	1
D-41925	15	90	8	1
D-42232	20	90	8	1
D-42248	25	90	8	1
D-42254	26	90	8	1
D-42260	30	90	8	1
D-42276	32	90	10	1
D-42282	35	90	10	1
D-42298	40	90	10	1
D-42307	50	90	10	1

FORSTNER 5PC BIT SET

D-47363

Sizes: 15mm, 20mm, 25mm, 30mm, 33mm

Complete with a wooden box

A high quality Forstner Drill Bit Set for the professional. For drilling accurate flat bottom holes in wood with excellent chip free results. Set includes popular sizes.



Batteries & Cases
Tool Holders
Drilling
Fixing
Saw Blades
Jigsaw & Recip
Multi Tool
Diamond
Bonded Abrasives
Flap Discs
Coated Abrasives
Router Cutters
Dust Extraction
Ground Maintenance

DRILLING: WOOD

STANDARD AUGER BITS

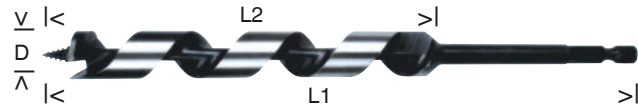

STANDARD AUGER SET 5PC

P-46464

Ground auger bits with threaded self drilling point. Excellent quality hole finish and roundness. Suitable for wood and wet wood. 6, 8, 13, 16, 19mm



Part No.	D mm	L1 mm	L2 mm	Pack
D-15992	6	200	130	1
D-16003	8	200	130	1
D-16019	10	200	130	1
D-16025	12	200	130	1
P-78455	13	235	130	1
D-16031	14	200	130	1
D-16047	16	200	130	1
D-16053	18	200	130	1
D-16069	20	200	130	1
D-16075	21	200	130	1

Self feeding and high cutting rate, the Hex fitting auger bit range is supplied in traditional 200mm lengths. Hex shank minimises chuck slippage and can be used with Makita's breakthrough 4-way combi-drill.



STANDARD AUGER BITS

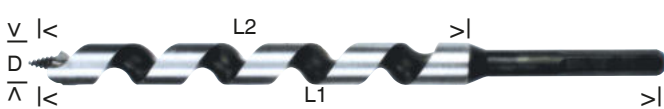

The Standard auger bit range is supplied in 400mm lengths. The bits come in sizes from 8mm to 30mm and are self feeding with a high cutting rate. Highly effective for boring clean and precise holes in soft or hard wood.



Part No.	D mm	L1 mm	L2 mm	Pack
D-07434	8	400	330	1
D-07440	10	400	330	1
D-07456	12	400	330	1
D-53475	13	250	180	1
D-53497	13	450	380	1
D-07462	14	400	330	1
D-53481	15	250	180	1
D-53506	15	450	380	1
D-07478	16	400	330	1
D-07484	18	400	330	1
D-07490	20	400	330	1
D-07509	22	400	330	1
D-07515	24	400	330	1
D-07521	26	400	330	1
D-07537	28	400	330	1
D-07543	30	400	330	1

SHIP AUGER BITS

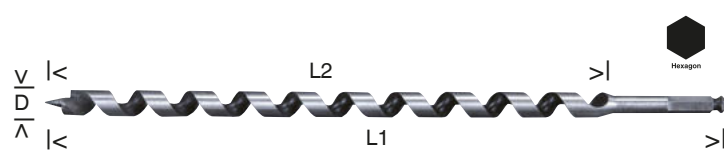

Designed for working in construction, shuttering and form work timber. Larger shank size for high torque applications.

Suitable for knotty nail embedded wood.

Hardened cutting edge and low-friction inner flute coating to reduce chip clogging.

10mm - 12mm > 8mm hex shank
14mm - 38mm > 11mm hex shank



Part No.	D mm	L1 mm	L2 mm	Pack
D-36055	10	165	120	1
D-36061	12	165	120	1
D-36077	14	165	120	1
D-36083	16	165	120	1
D-36099	18	165	120	1
D-36108	20	165	120	1
D-36114	22	165	120	1
D-36120	24	165	120	1
D-36136	26	165	120	1
D-36142	28	165	120	1
D-36158	30	165	120	1
D-36164	32	165	120	1
D-36170	35	165	120	1
D-36186	38	165	120	1
D-36192	10	470	400	1
D-36201	12	470	400	1
D-36217	14	470	400	1
D-36223	16	470	400	1
D-36239	18	470	400	1
D-36245	20	470	400	1
D-36251	22	470	400	1
D-36267	24	470	400	1
D-36273	26	470	400	1
D-36289	28	470	400	1
D-36295	30	470	400	1
D-36304	32	470	400	1
D-36310	35	470	400	1
D-36326	38	470	400	1

PERFORMANCE STUBBY AUGER BITS

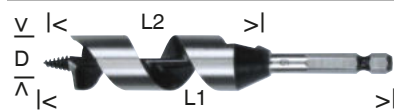

PERFORMANCE STUBBY AUGER SET 5PC

P-67686

20mm short length stubby auger bit set for wood working especially suited to working with angle screwdrivers or in tight spaces 16,19,22,25,32,mm



Master Carton: 12

Part No.	D mm	L1 mm	L2 mm	Pack
P-65872	10	120	90	1
P-65888	13	120	90	1
P-65894	16	120	90	1
P-65903	19	120	90	1
P-65919	22	120	90	1
P-65925	25	120	90	1
P-66422	32	120	90	1
P-66438	35	120	90	1

Especially designed to be used in angle drills enabling access into confined spaces. Excellent feed rate with low pressure required.



MATERIAL HOLESAW CHART

Application	Steel	INOX Stainless	Aluminum	Non-ferrous Metals	Wood	MDF	Plater Board	PVC	FRP	Soft Tile	Brick	Lime Stone	Marble	Hard Tile	Granite	Glass
Vacuum Brazed Diamond										••	••	••	••			
Ezy BIM	••	•	••	••	•			••								
BiM	••		•	•	••			••								
Multi Purpose TCT					••	••	••	••	••	•	•	••				
TCT Grit									••	••						
Diamond Wet										••			••	••	••	••

•• Recommended • Acceptable

Part No.	D mm	Arbor	Pack
----------	------	-------	------

STANDARD HOLESAWS



Bi-Metal holesaws

The Bi-Metal holesaw range have a varied-pitch tooth design and are recommended for cutting steel, aluminium, copper, brass, wood and plastic. Also available in plumbers and electricians kits with the most popular sizes. Arbours available with hex. (3 jaw chuck) and SDS-PLUS shanks.

Arbors

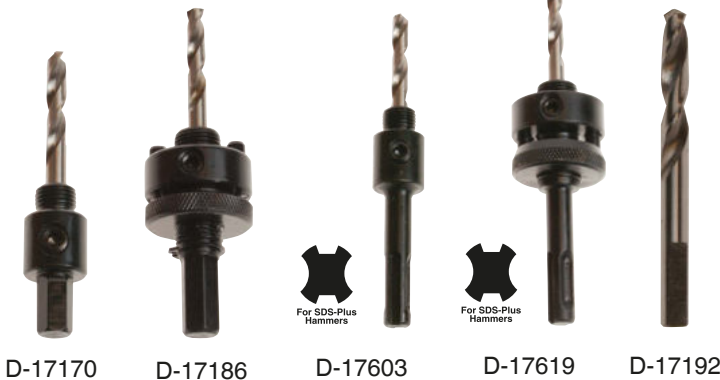

D-35368	14	D-17170 / D-17603	1
D-16994	16	D-17170 / D-17603	1
D-35374	17	D-17170 / D-17603	1
D-17005	19	D-17170 / D-17603	1
D-17251	20	D-17170 / D-17603	1
D-35380	21	D-17170 / D-17603	1
D-17011	22	D-17170 / D-17603	1
D-17027	24	D-17170 / D-17603	1
D-17033	25	D-17170 / D-17603	1
D-35396	27	D-17170 / D-17603	1
D-17267	29	D-17170 / D-17603	1
D-35405	30	D-17186 / D-17619	1
D-17049	32	D-17186 / D-17619	1
D-35411	33	D-17186 / D-17619	1
D-17055	35	D-17186 / D-17619	1
D-35427	37	D-17186 / D-17619	1
D-17061	38	D-17186 / D-17619	1
D-17273	40	D-17186 / D-17619	1
D-35433	41	D-17186 / D-17619	1
D-35449	43	D-17186 / D-17619	1
D-17077	44	D-17186 / D-17619	1
D-35455	46	D-17186 / D-17619	1
D-35461	48	D-17186 / D-17619	1
D-17083	51	D-17186 / D-17619	1
D-35477	52	D-17186 / D-17619	1
D-24876	54	D-17186 / D-17619	1
D-35483	56	D-17186 / D-17619	1
D-17099	57	D-17186 / D-17619	1
D-35499	59	D-17186 / D-17619	1
D-25688	60	D-17186 / D-17619	1
D-30140	64	D-17186 / D-17619	1
D-24882	65	D-17186 / D-17619	1
D-35508	67	D-17186 / D-17619	1
D-17108	68	D-17186 / D-17619	1
D-25694	70	D-17186 / D-17619	1
D-35514	73	D-17186 / D-17619	1
D-17114	76	D-17186 / D-17619	1
D-35520	79	D-17186	1
D-33869	80	D-17186	1
D-17120	83	D-17186	1
D-35536	86	D-17186	1
D-35542	89	D-17186	1
D-17136	92	D-17186	1
D-35558	95	D-17186	1
D-35564	98	D-17186	1
D-35570	102	D-17186	1
D-17142	105	D-17186	1
D-35586	108	D-17186	1
D-35592	111	D-17186	1
D-35601	114	D-17186	1
D-35617	121	D-17186	1
D-17158	127	D-17186	1
D-35623	140	D-17186	1
D-17164	152	D-17186	1

ARBORS

D-17170	16 - 29	Hex	1
D-17186	30 - 152	Hex	1
D-17603	14 - 29	SDS-PLUS	1
D-17619	30 - 76	SDS-PLUS	1
D-17192	6.5	Pilot drill	1

*Single holesaws clamshell packed

Batteries & Cases
Tool Holders
Drilling
Fixing
Saw Blades
Jigsaw & Recip
Multi Tool
Diamond
Bonded Abrasives
Flap Discs
Coated Abrasives
Router Cutters
Dust Extraction
Ground Maintenance

DRILLING: STANDARD HOLESAW KITS

16PC LARGE UNIVERSAL HOLESAW KIT D-47307

16, 19, 22, 25, 32, 35, 37,
44, 51, 57, 64, 68, 76mm
2x Arbor, 1x Spring
Aluminium case



14PC LARGE PLUMBERS HOLESAW KIT D-47298

19, 22, 25, 29, 35, 38,
44, 51, 57, 68, 75mm
2x Arbor, 1x Spring
Aluminium case



12PC LARGE PLUMBERS HOLESAW KIT D-47282

19, 22, 29, 35, 38, 51,
54, 57, 68mm
2x Arbor, 1x Spring
Aluminium case



8PC PLUMBERS HOLESAW KIT D-47117

19, 22, 29, 38, 44, 57mm
2x Arbor



8PC ELECTRICIANS HOLESAW KIT 1 D-47139

20, 25, 32, 40, 51, 65mm
2x Arbor



8PC ELECTRICIANS HOLESAW KIT 2 D-47123

16, 20, 25, 32, 40, 51mm
2x Arbor



5PC LARGE HOLESAW KIT D-34861

20, 25, 32, 51mm
Arbor



5PC SMALL HOLESAW KIT D-34855

20, 25, 32, 35mm
Arbor



PERFORMANCE HOLESAWS

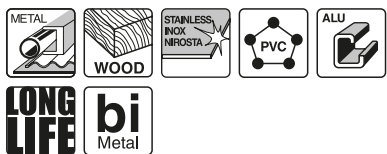

Bi-Metal Holesaws 5% Cobalt

HSS Bi-Metal variable pitch tooth 4-btpi with 5% cobalt content for high durability and extended working life. Suitable for wood, gypsum board, plastics, non ferrous metals, aluminium, steel and stainless steel.

Large range from 14 - 152mm with hex and SDS adaptors and extra long pilot drill.



P-35156



P-35162



P-35190



For SDS-Plus Hammers



P-35178

Part No.	D mm	Arbor No.	Pack
P-52451	14	P-35156 / P-35178	1
P-34936	16	P-35156 / P-35178	1
P-52467	17	P-35156 / P-35178	1
P-34942	19	P-35156 / P-35178	1
P-52473	20	P-35156 / P-35178	1
P-52489	21	P-35156 / P-35178	1
P-34958	22	P-35156 / P-35178	1
P-34964	24	P-35156 / P-35178	1
P-34970	25	P-35156 / P-35178	1
P-52495	27	P-35156 / P-35178	1
P-52504	29	P-35156 / P-35178	1
P-52510	30	P-35162 / P-35184	1
P-34986	32	P-35162 / P-35184	1
P-52526	33	P-35162 / P-35184	1
P-34992	35	P-35162 / P-35184	1
P-52532	37	P-35162 / P-35184	1
P-35003	38	P-35162 / P-35184	1
P-52548	40	P-35162 / P-35184	1
P-52554	41	P-35162 / P-35184	1
P-52560	43	P-35162 / P-35184	1
P-35019	44	P-35162 / P-35184	1
P-52576	46	P-35162 / P-35184	1
P-52582	48	P-35162 / P-35184	1
P-35025	51	P-35162 / P-35184	1
P-52598	52	P-35162 / P-35184	1
P-52607	54	P-35162 / P-35184	1
P-35031	57	P-35162 / P-35184	1
P-52613	59	P-35162 / P-35184	1
P-52629	60	P-35162 / P-35184	1
P-52635	64	P-35162 / P-35184	1
P-52641	65	P-35162 / P-35184	1
P-52657	67	P-35162 / P-35184	1
P-35047	68	P-35162 / P-35184	1
P-52663	70	P-35162 / P-35184	1
P-52679	73	P-35162 / P-35184	1
P-35053	76	P-35162 / P-35184	1
P-52685	79	P-35162 / P-35184	1
P-35069	83	P-35162 / P-35184	1
P-52691	86	P-35162 / P-35184	1
P-52700	89	P-35162 / P-35184	1
P-35075	92	P-35162 / P-35184	1
P-52716	95	P-35162 / P-35184	1
P-52722	98	P-35162 / P-35184	1
P-52738	102	P-35162 / P-35184	1
P-35081	105	P-35162 / P-35184	1
P-52744	108	P-35162 / P-35184	1
P-52750	111	P-35162 / P-35184	1
P-52766	114	P-35162 / P-35184	1
P-52772	121	P-35162 / P-35184	1
P-35097	127	P-35162 / P-35184	1
P-52788	140	P-35162 / P-35184	1
P-52794	146	P-35162 / P-35184	1
P-35106	152	P-35162 / P-35184	1
ARBORS			
P-35156	14 - 30	9.5mm Hex	1
P-35162	32 - 210	11mm Hex	1
P-35190	32 - 210	11mm Hex Quick Release	1
P-35178	14 - 30	SDS-PLUS	1
P-35184	32 - 210	SDS-PLUS	1
P-35209	83mm	Pilot Drill	1
P-35215	102mm	Pilot Drill	1

RECOMMENDED RPM FOR HOLESAWS

Diameter	Metal	Copper	Aluminium	Stainless Inox	Wood	Diameter	Metal	Copper	Aluminium	Stainless Inox	Wood
16	530	730	825	275	3000	57	170	230	255	85	2000
19	460	600	690	230	3000	57	150	200	225	75	2000
20	440	580	675	220	3000	60	140	190	220	70	2000
22	390	520	585	195	3000	64	135	180	205	65	1850
24	370	490	555	185	2700	68	130	170	190	65	1800
25	350	470	525	175	2700	70	125	160	185	60	1800
29	300	400	450	150	2700	76	115	150	170	55	1800
30	285	380	425	145	2400	83	105	140	155	50	1500
32	275	360	410	140	2400	92	90	120	140	45	1200
35	250	330	375	125	2400	102	85	110	130	40	1000
38	230	300	345	115	2400	105	85	110	130	40	1000
41	210	280	315	105	2100	127	80	110	120	40	1000
44	195	260	295	95	2100	152	65	90	90	30	800
48	180	240	270	90	2100						

EZYCHANGE HOLESAWS

Ezychange



HSS Bi-Metal Ezychange holesaws

Only one arbour needed is for the range of 16 - 152mm with quick release pilot drill and core body. This not only allows speedy size changes but is also a safer method for the user. Manufactured from HSS Bi-Metal with 8% cobalt and progressive tooth geometry, ensures long service life and high cutting speeds suitable for ferrous and non ferrous metal, stainless steel, Aluminium, wood and plastics. Ezychange holesaws can be purchased individually or as a kit designed with the right sizes to suit your trade. Compatible with other major manufacturers quick change holesaws.

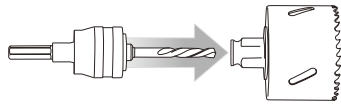
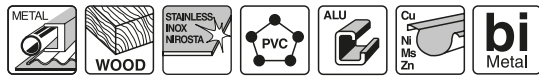

Part No.	D mm	Arbor No.	Pack

B-11265	16	B-11536	1
B-31706	17	B-11536	1
B-11271	19	B-11536	1
B-11287	20	B-11536	1
B-11293	22	B-11536	1
B-11302	24	B-11536	1
B-11318	25	B-11536	1
B-31712	27	B-11536	1
B-11324	29	B-11536	1
B-11330	30	B-11536	1
B-11346	32	B-11536	1
B-11352	35	B-11536	1
B-31728	37	B-11536	1
B-11368	38	B-11536	1
B-16754	40	B-11536	1
B-11374	41	B-11536	1
B-11380	44	B-11536	1
B-31734	46	B-11536	1
B-11396	48	B-11536	1
B-11405	51	B-11536	1
B-31740	52	B-11536	1
B-18194	54	B-11536	1
B-31756	56	B-11536	1
B-11411	57	B-11536	1
B-11427	60	B-11536	1
B-11433	64	B-11536	1
B-16760	65	B-11536	1
B-11449	68	B-11536	1
B-11455	70	B-11536	1
B-31762	73	B-11536	1
B-11461	76	B-11536	1
B-31778	79	B-11536	1
B-11477	83	B-11536	1
B-31784	86	B-11536	1
B-11483	92	B-11536	1
B-31790	95	B-11536	1
B-11499	102	B-11536	1
B-11508	105	B-11536	1
B-31809	111	B-11536	1
B-31815	114	B-11536	1
B-31821	121	B-11536	1
B-11514	127	B-11536	1
B-31837	140	B-11536	1
B-11520	152	B-11536	1
EZYCHANGE ADAPTORS			
B-11536	Ezychange arbour +HSS pilot		1
B-31902	SDS-Plus adaptor without Pilot Drill		1
B-11542	HSS Pilot Drill Bit		1
B-16271	Adaptor set 6PC 14-30mm 32-152mm		1

10PC EZYCHANGE LARGE ELECTRICIANS HOLESAW KIT B-18188

25, 32, 40, 51, 65, 68, 76mm
Ezychange adaptor, 2x HSS Pilot Bit

8PC EZYCHANGE LARGE ELECTRICIANS HOLESAW KIT B-11988

20, 25, 32, 40, 51, 65mm
Ezychange Adaptor, HSS Pilot Bit

8PC EZYCHANGE ELECTRICIANS HOLESAW KIT B-11972

16, 20, 25, 32, 40, 51mm
Ezychange adaptor, HSS Pilot Bit

B-11536 B-31902 B-11542 B-16271

8PC EZYCHANGE PLUMBERS HOLESAW KIT B-11966

19, 22, 29, 38, 44, 57mm
Ezychange adaptor, HSS Pilot Bit

MULTI-PURPOSE TCT HOLESAW

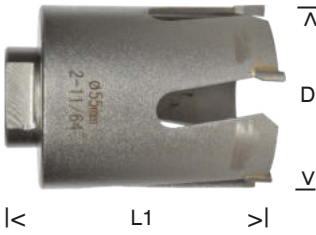

For wood, chipboard, plywood, plastic, plasterboard, brick, limestone, soft tile, etc.



Part No.	D mm	L1 mm	L2 mm	Pack
D-42684	22	60		1
D-42690	25	60		1
D-42709	29	60		1
D-42715	30	60		1
D-42737	35	60		1
D-42743	38	60		1
D-42759	40	60		1
D-42765	45	60		1
D-42787	50	60		1
D-42793	51	60		1
D-42818	55	60		1
D-42824	57	60		1
D-42830	60	60		1
D-42846	64	60		1
D-42852	65	60		1
D-42874	68	60		1
D-42880	70	60		1
D-45032	76	60		1
D-45331	80	60		1
D-45353	85	60		1
D-50326	105	60		1

10PC ELECTRICIANS HOLESAW KIT

D-51281

TCT:
22, 25, 29, 35, 38, 45, 51mm
Pilot 10x100mm
TCT Pilot 8x100mm
13mm Hex adaptor



9PC ELECTRICIANS HOLESAW KIT

D-51297

TCT:
22, 35, 51, 57, 64, 76mm
Pilot 10x100mm
TCT Pilot 8x100mm
13mm Hex adaptor



TUNGSTEN CARBIDE GRIT HOLESAW



The Tungsten Carbide Grit Holesaw is ideally suited to plumbers and interior contractors for drilling exclusively into soft tile and soft brick.

D-51188	33	54		1
D-51194	43	57		1
D-51203	53	57		1
D-51219	63	57		1
D-51225	67	57		1
D-51231	73	57		1
D-51247	83	57		1

ADAPTORS AND PILOT DRILLS

D-51253	7/16" Hex Arbor + Pilot			1
D-51269	90mm Pilot			1

VACUUM BRAZED HOLESAWS



The Vacuum brazed diamond holesaw features a rim of high quality diamonds that are vacuum brazed to the leading edge. This material joining process creates a bond which is significantly stronger than alternative methods. The benefits this offers to the tradesman are; faster drilling, increased durability and better suitability across a wider range of applications. They are ideal for all types of standard thickness wall and floor tiles, and can also be used to drill through deeper natural stone paving slabs, brick and marble.



B-45995	16			1
B-46006	19			1
B-46012	25			1
B-46028	30			1
B-46034	32			1
B-46040	35			1
B-46056	38			1
B-46062	45			1
B-46078	50			1
B-46084	53			1
B-46090	57			1
B-46109	64			1
B-53914	68			1

STRAIGHT SHANK AND PILOT DRILLS

B-46115	Straight Shank and Center Drill			1
B-46121	Center Drill 59mm/M6			1
B-46137	Straight Shank 182mm/M12-M6			1

FOR SDS-PLUS

B-52691	Shank and Center Drill			1
B-52700	Shank 182mm/M12-M6			1

DRILLING: WET HOLESAWS

DIAMOND WET HOLESAW FOR HARD CERAMICS

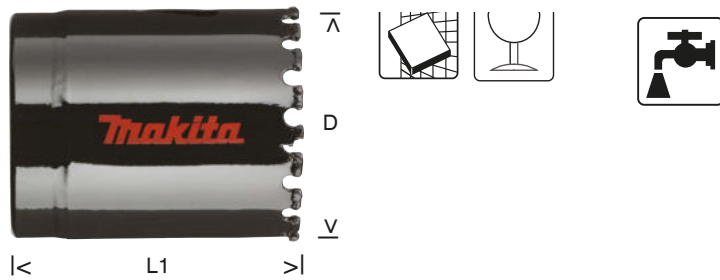

Range of wet holesaws with diamond grit for faster cutting and longer life even on harder materials. Can cut through tile, granite, marble, glass, etc.

Simply dab into a water source and drill.

Part No.	D mm	L mm	Pack
D-61210	19		1
D-61226	20		1
D-61232	22		1
D-61248	25		1
D-61254	29		1
D-61260	32		1
D-61276	35		1
D-61282	38		1
D-61298	41		1
D-61307	44		1
D-61313	51		1
D-61329	54		1
D-61335	57		1
D-61341	60		1
D-61357	64		1
D-61363	65		1
D-61379	67		1
D-61385	68		1
D-61391	70		1
D-61400	76		1
D-61416	79		1
D-61422	83		1

ADAPTORS AND PILOT DRILLS

D-61438	9.5mm HEX Adaptor 19-29mm holesaw		1
D-61444	11mm HEX Adaptor 32-83mm holesaw		1
D-61450	Retractable Starter Pilot Bit 6mm x 74mm		1

MINI DIAMOND DRILLS

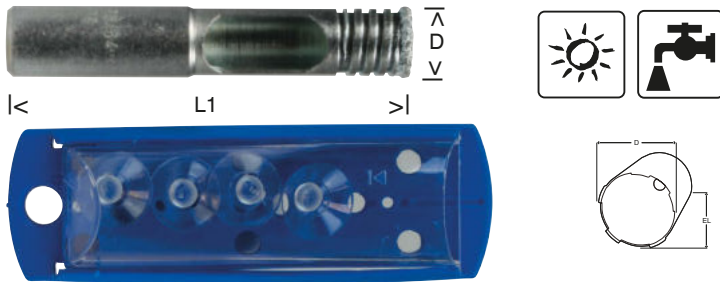

Part No.	D mm	L mm	Pack
P-66569	5	30	1
P-66575	6	30	1
P-66581	7	30	1
P-66597	8	30	1
P-66612	10	30	1
P-66709	12	30	1
P-66715	15	30	1
P-66721	20	30	1
P-66737	25	30	1

MINI DIAMOND DRILLS SET 3PC P-66628

P-66628

6, 8, 10x30mm

Complete with water reservoir.



MINI DIAMOND DRILLS SET 6PC P-83646

P-83646

6, 8, 10, 15, 20, 25x30mm

Complete with water reservoir.



MINI DIAMOND DRILLS SET 3PC P-66983

P-66983

15, 20, 25x30mm

Complete with water reservoir.



STANDARD MASONRY TCT

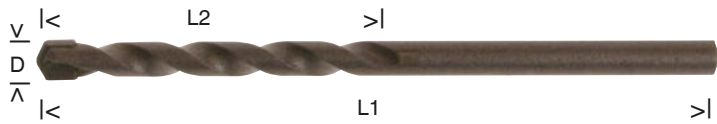

Masonry drill bits

A good general masonry bit available in popular sizes and lengths for the construction industry.



SET 5PC	D-05175	SET 5PC	D-20719
4x70mm 5x70mm 6x70mm 8x110mm 10x110mm		5x110mm 6x110mm 7x110mm 8x110mm 10x110mm	

Part No.	D mm	L1 mm	L2 mm	Pack
D-05228	3	60	36	1
D-05234	4	70	40	1
D-05240	5	85	50	1
D-05256	6	101	60	1
D-05262	6	150	90	1
P-81206	6.5	600		1
D-05278	7	101	60	1
D-05284	7	150	90	1
D-05290	8	110	90	1
D-05309	8	150	90	1
P-81212	8	600		1
D-05315	9	150	90	1
D-05321	10	150	90	1
D-18960	10	400	360	1
P-81228	10	1000		1
D-05337	11	150	90	1
D-05343	12	150	90	1
D-17697	12	400	350	1
D-17728	12	600	350	1
D-05359	13	150	90	1
D-05365	14	150	90	1
D-18976	14	400	350	1
D-05371	15	150	90	1
D-05387	16	150	90	1
D-17706	16	400	350	1
D-17734	16	600	550	1
D-18982	18	400	350	1
D-17712	20	400	350	1
D-17740	20	600	550	1

STANDARD MASONRY HEX FITTING



1/4" Hexagon shank masonry

Suitable for use with quick change chuck systems, impact drivers and percussion drills. For drilling brick, stone gypsum, lime stone and manufactured artificial stones.



D-23771	3	80	40	1
D-23787	4	80	40	1
D-23793	5	90	55	1
D-23802	6	100	60	1
D-23818	8	100	60	1

PERFORMANCE MASONRY TCT



Performance Masonry straight shank

This is a high-quality drill bit for use with percussion drills on brick, block, stone or light concrete. The tungsten carbide tip is manufactured to DIN8039 standard.

Available in standard or long lengths.



SET 5PC	P-34849	SET 13PC	P-51889
5.5x150mm 6x150mm 7x150mm 8x150mm 10x150mm		4, 5, 5.5mm x3 6mm x2 6.5mm x2 7mm x2 8mm x2	

STANDARD LENGTH				
P-19663	3	60	30	1
P-19679	3.5	75	40	1
P-19685	4	75	40	1
P-19691	4.5	85	45	1
P-19700	5	85	45	1
P-26113	5	150	95	1
P-19716	5.5	95	52	1
P-26129	5.5	150	95	1
P-19722	6	100	55	1
P-26135	6	150	95	1
P-19738	6.5	100	55	1
P-67131	6.5	150	95	1
P-19744	7	100	55	1
P-26141	7	150	95	1
P-19750	8	120	65	1
P-26157	8	150	95	1
P-19766	9	120	65	1
P-19772	10	120	65	1
P-26179	10	150	95	1
P-19788	11	150	90	1
P-19794	12	150	85	1
P-19803	13	150	85	1
P-30178	14	150	85	1
P-30184	15	150	85	1
P-30190	16	150	85	1

LONG LENGTH				
P-23830	6	400	270	1
P-23846	7	400	270	1
P-23852	8	400	270	1
P-23868	9	400	270	1
P-23874	10	400	270	1
P-23880	12	400	270	1
P-23896	13	400	270	1
P-23905	14	400	270	1
P-23911	16	400	270	1
P-23927	18	400	270	1
P-23933	20	400	270	1

Batteries & Cases
Tool Holders
Drilling
Fixing
Saw Blades
Jigsaw & Recip
Multi Tool
Diamond
Bonded Abrasives
Flap Discs
Coated Abrasives
Router Cutters
Dust Extraction
Ground Maintenance

ELITE MASONRY TCT

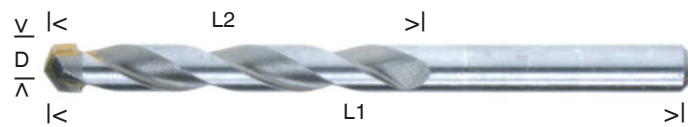

Elite Masonry straight shank

This high quality masonry bit offers a percussion ground tungsten tip, a machined body to reduce drag and a deep L shaped flute for a more efficient dust removal technique. This bit is made for use with percussion drills but is particularly useful when combined with a cordless tool as the number of holes that can be drilled between charges can increase by up to 25%.



STANDARD LENGTH				
Part No.	D mm	L1 mm	L2 mm	Pack
P-22676	3	60	30	1
P-22682	4	75	40	1
P-22698	5	85	50	1
P-22713	6	100	60	1
P-22729	6.5	100	60	1
P-22735	7	100	60	1
P-22741	8	120	72	1
P-22757	9	120	72	1
P-22763	10	120	72	1
P-22779	11	150	82	1
P-22785	12	150	82	1
P-22791	13	150	82	1
P-30209	14	150	82	1
P-30215	15	150	82	1
P-30221	16	150	82	1
LONG LENGTH				
P-22800	6	400	250	1
P-22816	7	400	250	1
P-22822	8	400	250	1
P-22838	9	400	250	1
P-22844	10	400	250	1
P-22850	12	400	250	1
P-22866	13	400	250	1
P-22872	14	400	250	1
P-22888	16	400	250	1
P-22894	18	400	250	1
P-22903	20	400	250	1

ELITE MASONRY TCT SET P-23787

4, 5, 6, 8, 10mm x 75-120mm

OMNIBOHRER MULTIPURPOSE DRILL BITS

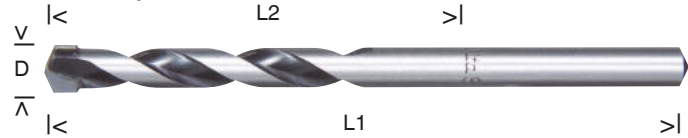

Suitable for use within concrete, tile, brick, slate, limestone, wood, sandwich materials, aluminium, plastics and metal. Eliminates need to switch between different drill bit types and features tungsten carbide tip for fast and efficient drilling.



D-30287	3	60	1
D-30293	4	70	1
D-30302	5	85	1
D-31027	5.5	85	1
D-31033	5.5	100	1
D-31049	5.5	150	1
D-30318	6	100	1
D-30324	6	150	1
D-31055	6.5	85	1
D-31061	6.5	100	1
D-31077	6.5	150	1
D-30330	7	100	1
D-30346	7	150	1
D-30352	8	110	1
D-30368	8	150	1
D-30374	9	150	1
D-30380	10	150	1
D-30396	10	400	1
D-30405	11	150	1
D-30411	12	150	1
D-30427	12	400	1
D-30433	12	600	1
D-30449	13	150	1
D-30455	14	150	1
D-30461	14	400	1

OMNIBOHRER MULTIPURPOSE SET 5PC D-30477

5x85mm
8x110mm
12x150mm
6x100mm
10x150mm

OMNIBOHRER MULTIPURPOSE SET 5PC D-36712

4x70mm
5x85mm
6x100mm
8x150mm
10x150mm

STANDARD SDS-PLUS

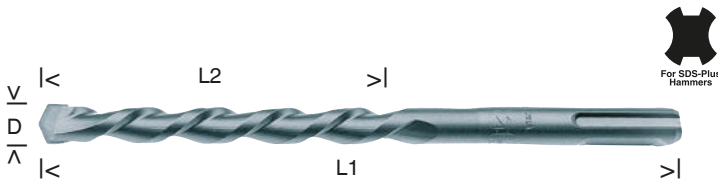

2 cutter SDS plus drill bits suitable for masonry and concrete. The solid carbide tip with centering point and optimised flutes offers fast drilling speeds in a contractors, low cost option.



Part No.	D mm	L1 mm	L2 mm	Pack
D-00016	4	110	50	1
D-00022	5	110	50	1
D-00038	5	160	100	1
D-00044	5.5	110	50	1
D-16106	5.5	160	100	1
D-00050	6	110	50	1
D-00066	6	160	100	1
D-00072	6	210	150	1
D-00088	6.5	110	50	1
D-00094	6.5	160	100	1
D-00103	7	110	50	1
D-00119	7	160	100	1
D-00125	8	110	50	1
D-00131	8	160	100	1
D-00147	8	210	150	1
D-00153	8	260	200	1
D-08056	9	160	100	1
D-00175	10	160	100	1
D-00181	10	210	150	1
D-00197	10	260	200	1
D-00212	11	160	100	1
D-00228	12	160	100	1
D-00234	12	210	150	1
D-00240	12	260	200	1
D-14102	12.5	160	100	1
D-00256	13	160	100	1
D-00262	14	160	100	1
D-00278	14	260	200	1
D-00284	15	160	100	1
D-17550	15	460	400	1
D-03981	16	160	100	1
D-00290	16	210	150	1
D-16156	16	260	200	1
D-00309	16	310	250	1
D-16287	16	460	400	1
D-00315	17	210	150	1
D-00321	18	210	150	1
D-00337	18	300	250	1
D-17566	18	460	400	1
D-00343	19	210	150	1
D-16293	19	460	400	1
D-00359	20	210	150	1
D-00365	20	310	250	1
D-15235	20	460	400	1
D-00371	22	260	200	1
D-15241	22	460	400	1
D-16302	24	460	400	1
D-00387	25	260	200	1
D-15257	25	460	400	1
D-00393	26	260	200	1
D-15263	26	460	400	1
D-16318	28	460	400	1
D-17572	30	460	400	1

MULTI PACK STANDARD SDS-PLUS

D-03888

- 5.5x110mm
- 7x110mm
- 6x160mm
- 7x160mm
- 8x160mm



MULTI PACK STANDARD SDS-PLUS

D-44987

- 5.8x110mm
- 6.5x110mm
- 6.5x60mm
- 9.5x160mm
- 12.7x160mm



GLASS BITS



Makita Glass Bits with arrow tip head provide excellent cutting in glass and ceramics. Ideal for work in Kitchen or Bathroom.



STRAIGHT SHANK				
D-25111	3	65	45	1
D-25127	4	65	45	1
D-25133	5	65	45	1
D-25149	6	65	45	1
D-25155	8	70	50	1
D-25161	10	80	60	1
D-25177	12	80	60	1
HEX SHANK				
D-15942	4	65	30	1
D-15958	5	65	30	1
D-15964	6	65	30	1
D-15970	8	70	35	1
D-15986	10	80	40	1

Batteries & Cases
Tool Holders
Drilling
Fixing
Saw Blades
Jigsaw & Recip
Multi Tool
Diamond
Bonded Abrasives
Flap Discs
Coated Abrasives
Router Cutters
Dust Extraction
Ground Maintenance

PERFORMANCE SDS-PLUS

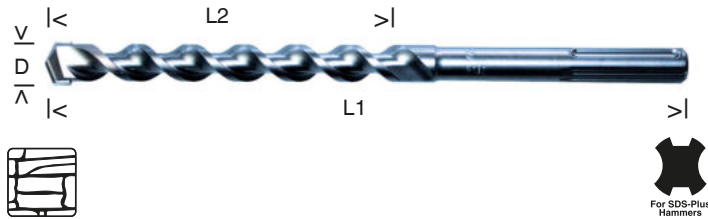

A European manufactured hammer drill with a patented, high-volume, multi-flute that quickly channels the drilling dust from the hole, saving both time and money. Due to its aggressive design, the fast and durable carbide tip allows easy centring and spot drilling. Designed for regular professional use, providing excellent performance in the toughest of materials. Also excellent for drilling in high resistance materials such as Green Concrete or Engineering Brick. The unique reinforced flute geometry transfers more impact energy from the rotary hammer to the drill head, reducing stress for user and power tool. The design and technology innovations of these SDS drill bits significantly raised the performance parameters of drilling speed and life expectancy.

Available from 4 - 26mm diameter. 110 - 1000mm overall length.

PERFORMANCE SDS-PLUS MULTI PACK P-66070

5x110mm	7x160mm
5.5x110mm	8x160mm
6x110mm	9x160mm
7x110mm	10x160mm
5.5x160mm	
6x160mm	

Part No.	D mm	L1 mm	L2 mm	Pack
B-47232	4	110	50	1
B-46492	5	110	50	1
B-46501	5	160	100	1
B-47298	5.5	110	50	1
B-47307	5.5	160	100	1
B-47313	5.5	210	150	1
B-46517	6	110	50	1
B-46523	6	160	100	1
B-47341	6	210	150	1
B-47357	6	260	200	1
B-47385	6.5	110	50	1
B-47391	6.5	160	100	1
B-47400	6.5	210	150	1
B-47416	6.5	260	200	1
B-47422	6.5	310	250	1
B-47438	7	110	50	1
B-47444	7	160	100	1
B-47450	7	210	150	1
B-46539	8	110	50	1
B-46545	8	160	100	1
B-47472	8	210	150	1
B-47488	8	260	200	1
B-47503	8	400	350	1
B-47525	8	600	550	1
B-47531	9	160	100	1
B-47547	9	210	150	1
B-47553	9.5	160	100	1
B-46551	10	110	50	1
B-46567	10	160	100	1
B-47569	10	210	150	1
B-47575	10	260	200	1
B-47581	10	310	250	1
B-47597	10	350	300	1
B-47606	10	450	400	1
B-47612	10	600	550	1
B-47634	10	1000	950	1
B-47640	11	160	100	1
B-47656	11	210	150	1
B-47662	11	260	200	1
B-46573	12	160	100	1
B-47684	12	210	150	1
B-47690	12	260	200	1
B-47709	12	310	250	1
B-47721	12	450	400	1
B-47737	12	600	550	1
B-47759	12	1000	950	1
B-47765	13	160	100	1
B-47771	13	210	150	1
B-47787	13	260	200	1
B-47793	13	310	250	1
B-46589	14	160	100	1
B-47802	14	210	150	1
B-47818	14	260	200	1
B-47824	14	310	250	1
B-47830	14	450	400	1
B-47846	14	600	550	1
B-47852	14	1000	950	1
B-47868	15	160	100	1
B-47874	15	210	150	1
B-47880	15	260	200	1
B-47896	15	450	400	1
B-47905	16	160	100	1
B-47911	16	210	150	1
B-47933	16	310	250	1
B-47949	16	450	400	1
B-47955	16	600	550	1
B-47961	16	800	750	1
B-47977	16	1000	950	1
B-47983	17	210	150	1
B-48000	18	200	150	1
B-48016	18	300	250	1
B-48022	18	450	400	1
B-48038	18	600	550	1
B-48044	18	1000	950	1
B-48050	19	200	150	1
B-48066	19	450	400	1
B-48072	20	200	150	1
B-48088	20	300	250	1
B-48094	20	450	400	1
B-48103	20	600	550	1
B-48125	20	1000	950	1
B-48131	22	250	200	1
B-48147	22	450	400	1
B-48169	22	1000	950	1
B-48175	23	250	200	1
B-48197	24	250	200	1
B-48206	24	450	400	1
B-48212	24	600	550	1
B-48228	25	250	200	1
B-48234	25	450	400	1
B-48256	25	1000	950	1
B-48262	26	250	200	1
B-48278	26	450	400	1

NEMESIS 2 SDS-PLUS



RESOLVES PROBLEMS

Drilling into reinforced concrete is no longer a hit and miss application, reinforcing bar being no obstacle for the Nemesis drill. Also perfect for use in the hardest of natural stone.

DRILLS MORE PRECISELY

Its unique symmetrical head geometry ensures precision drill holes. Perfect for critical anchor fixings and where spot drilling is required.

LASTS LONGER

The Nemesis will drill up to 50% more holes than normal rotary hammer drill bits.

NEMESIS 2 MIXED PACK 7PC

B-12304

- 5.5x110mm
- 5.5x160mm
- 6x110mm
- 6.5x160mm
- 7x160mm
- 8x160mm
- 10x160mm



NEMESIS 2 MIXED PACK 5PC

B-59003

- 5.5x110mm
- 6x160mm
- 7x110mm
- 7x160mm
- 8x160mm



Part No.	D mm	L1 mm	L2 mm	Pack
B-57897	5	110	50	1
B-57906	5	160	100	1
B-57912	5	210	150	1
B-57928	5	260	200	1
B-57940	5.5	110	50	1
B-57956	5.5	160	100	1
B-57962	6	110	50	1
B-57978	6	160	100	1
B-57984	6	210	150	1
B-57990	6	260	200	1
B-58001	6	310	250	1
B-58023	6.5	160	100	1
B-58039	6.5	210	150	1
B-58045	6.5	260	200	1
B-58051	6.5	310	250	1
B-58067	7	110	50	1
B-58073	7	160	100	1
B-58089	7	215	150	1
B-58095	8	110	50	1
B-58104	8	160	100	1
B-58110	8	210	150	1
B-58126	8	260	200	1
B-58132	8	310	250	1
B-58182	9	265	200	1
B-58198	10	110	50	1
B-58207	10	160	100	1
B-58213	10	210	150	1
B-58229	10	260	200	1
B-58235	10	310	250	1
B-58257	10	450	400	1
B-58263	10	600	550	1
B-58279	10	1000	950	1
B-58285	11	160	100	1
B-58291	11	210	150	1
B-58300	11	260	200	1
B-58316	11	310	250	1
B-58322	12	160	100	1
B-58338	12	210	150	1
B-58344	12	260	200	1
B-58350	12	310	250	1
B-58366	12	450	400	1
B-58372	12	600	550	1
B-58388	12	1000	950	1
B-58431	14	160	100	1
B-58447	14	210	150	1
B-58453	14	260	200	1
B-58469	14	310	250	1
B-58475	14	450	400	1
B-58481	14	600	550	1
B-58497	14	1000	950	1
B-58506	15	150	100	1
B-58512	15	210	150	1
B-58528	15	260	200	1
B-58534	15	450	250	1
B-58540	16	160	100	1
B-58556	16	210	150	1
B-58562	16	260	200	1
B-58578	16	310	250	1
B-58584	16	450	400	1
B-58590	16	600	550	1
B-58609	16	1000	950	1
B-58615	18	250	200	1
B-58621	18	450	400	1
B-58637	20	250	200	1
B-58659	20	450	400	1
B-58665	22	250	200	1
B-58687	22	450	400	1
B-58693	24	250	200	1
B-58702	24	450	400	1
B-58718	25	250	200	1
B-58724	25	450	400	1
B-58746	28	250	200	1
B-58752	28	450	400	1
B-58768	30	250	200	1
B-58774	30	450	400	1
B-58780	32	450	400	1



Batteries & Cases
Tool Holders
Drilling
Fixing
Saw Blades
Jigsaw & Recip
Multi Tool
Diamond
Bonded Abrasives
Flap Discs
Coated Abrasives
Router Cutters
Dust Extraction
Ground Maintenance

STANDARD SDS-MAX ***

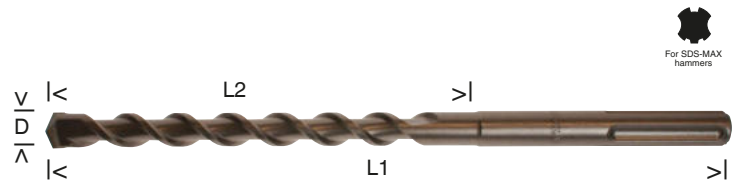

Standard
2 cutter SDS-MAX drill bits suitable for masonry and concrete. Solid carbide tip with centring point and optimised flutes offers fast drilling speeds for contractors. 12-40mm.



Part No.	D mm	L1 mm	L2 mm	Pack
D-33875	12	340	200	1
D-33881	12	530	400	1
D-33897	14	340	200	1
D-33906	14	540	400	1
D-33912	15	340	200	1
D-33928	15	540	400	1
D-33934	16	340	200	1
D-33940	16	540	400	1
D-33956	18	340	200	1
D-33962	18	540	400	1
D-33978	20	340	200	1
D-33984	20	540	400	1
D-33990	22	340	200	1
D-34001	22	540	400	1
D-34017	24	340	200	1
D-34023	24	540	400	1
D-34039	25	340	200	1
D-34045	25	540	400	1
D-34051	28	370	250	1
D-34067	28	570	450	1
D-34073	30	370	250	1
D-34089	30	540	450	1
D-34095	32	370	250	1
D-34104	32	570	450	1
D-34110	35	370	250	1
D-34126	35	570	450	1
D-34132	38	370	250	1
D-34148	38	570	450	1
D-34154	40	370	250	1
D-34160	40	570	450	1

PERFORMANCE SDS-MAX ****

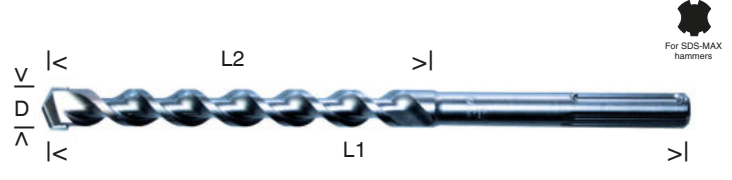

Performance
High quality 2 cutter bit with reinforced flute and centring point. The fast and durable carbide tip allows easy centring and spot drilling, whilst the dynamic chisel shaped drill bit head easily penetrates the material. Reinforced flute geometry reduces vibration and increases the life expectancy of the drill bit for tougher jobs in masonry and concrete. 14-40mm.

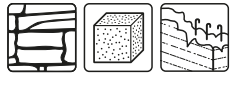

Part No.	D mm	L1 mm	L2 mm	Pack
P-70655	14	340	200	1
P-70661	14	540	400	1
P-70677	16	340	200	1
P-70683	16	540	400	1
P-70699	18	340	200	1
P-70708	18	540	400	1
P-70714	20	320	200	1
P-70720	20	520	400	1
P-70736	22	320	200	1
P-70742	22	520	400	1
P-70758	24	320	200	1
P-70764	24	520	400	1
P-70770	25	320	200	1
P-70786	25	520	400	1
P-70792	28	370	250	1
P-70801	28	570	450	1
P-70817	30	370	250	1
P-70823	30	570	450	1
P-70839	32	370	250	1
P-70845	32	570	450	1
P-70851	35	370	250	1
P-70867	35	570	450	1
P-70873	38	370	250	1
P-70889	38	570	450	1
P-70895	40	370	250	1
P-70904	40	570	450	1

MAK4 SDS-MAX



MAK4 SDS-MAX

Premium SDS-MAX drill with a dynamic 4-cutter head. Symmetrical head-geometry with cutting-tip for optimised results in the event of reinforcement collision. Shortened spiral windings and conical shaped dust tracks for extra fast material removal into the high-volume double flute. The MAK4 significantly raises the performance parameters of drilling speed and life expectancy. This considerably reduces the cost per hole. 12-52mm diameter and 200-1200mm working length.

Bit diameters 12mm-15mm are 2 cutter.



Part No.	D mm	L1 mm	L2 mm	Pack
P-17033	12	340	200	1
P-17049	12	540	400	1
P-17055	12	690	550	1
P-17077	14	340	200	1
P-17083	14	540	400	1
P-17108	15	340	200	1
P-17114	15	540	400	1
P-77730	16	340	200	1
P-77746	16	540	400	1
P-77752	16	920	800	1
P-77768	16	1320	1200	1
P-77774	18	340	200	1
P-77780	18	540	400	1
P-77805	18	1320	1200	1
P-77811	20	320	200	1
P-77827	20	520	400	1
P-77833	20	920	800	1
P-77849	20	1320	1200	1
P-77855	22	320	200	1
P-77861	22	520	400	1
P-77877	22	920	800	1
P-77883	22	1320	1200	1
P-77899	24	320	200	1
P-77908	24	520	400	1
P-77914	25	320	200	1
P-77920	25	520	400	1
P-77936	25	920	800	1
P-77942	25	1320	1200	1
P-77958	26	520	400	1
P-77964	28	370	250	1
P-77970	28	570	450	1
P-77986	28	670	550	1
P-77992	28	920	800	1
P-78003	28	1320	1200	1
P-78019	30	370	250	1
P-78025	30	570	450	1
P-78031	32	370	250	1
P-78047	32	570	450	1
P-78053	32	920	800	1
P-78069	32	1320	1200	1
P-78075	35	370	250	1
P-78081	35	570	450	1
P-78097	35	670	550	1
P-78592	35	1320	1200	1
P-78106	37	370	250	1
P-78112	37	570	450	1
P-78128	37	920	800	1
P-78134	38	370	250	1
P-78140	38	570	450	1
P-78156	40	370	250	1
P-78162	40	570	450	1
P-78178	40	920	800	1
P-78184	40	1320	1200	1
P-78190	45	570	450	1
P-78215	50	570	450	1
P-78221	52	570	450	1

CAVITY WALL DRILLING BITS SDS-MAX

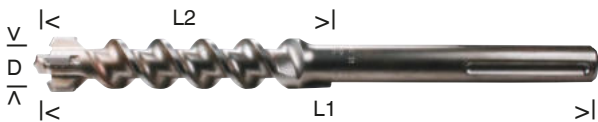

Cavity Wall Drilling Bits SDS-MAX

Specifically designed for cavity wall insulation technicians. Features a special pilot tip to prevent brick damage when starting to drill into mortar joints. Reinforced outer cutters prevent wear to the drill bit and considerably extends working life. The special length prevents cavity breach and drilling into the inner wall skin.



P-72796	22	265	130	1
P-72805	26	265	130	1

DUST EXTRACTION DRILL BITS SDS-PLUS AND SDS-MAX

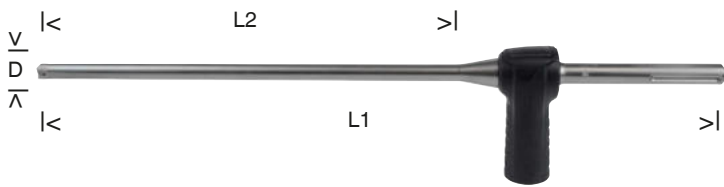

Dust extraction TCT drills bits available in SDS+ and SDS-MAX can remove dust as you drill when attached to a dust extractor. Dust is extracted through holes in the tip of the drill bit and is suitable for indoor and outdoor applications.

SDS-PLUS				
B-64381	12	325	200	1
B-64397	14	360	240	1
B-64406	16	360	240	1
B-64412	18	360	240	1
SDS-MAX				
B-64428	16	600	400	1
B-64434	18	600	400	1
B-64440	20	600	400	1
B-64456	22	600	400	1
B-64462	24	600	400	1
B-64478	25	600	400	1
B-64484	28	600	400	1
B-64490	28	900	700	1
B-64509	30	600	400	1
B-64515	30	900	700	1
B-64521	32	600	400	1
B-64537	32	900	700	1
B-64543	35	600	400	1
B-64559	35	900	700	1

HOLLOW CORE BITS

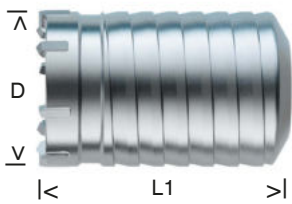

Hollow Core bits for use in concrete, masonry and stone. Excellent rotational stability and tool alignment with roof shaped guide teeth. Flat hammer teeth work with high efficiency, in such a prepared drilling base.

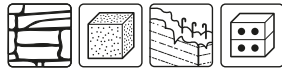

HOLLOW HAMMER CORE BIT				
P-73405	35	100		1
P-03779	40	100		1
P-73411	45	100		1
P-03785	50	100		1
P-03791	65	100		1
P-03800	80	100		1
P-03816	90	100		1
P-03822	100	100		1
P-16374	125	100		1
ADAPTORS				
P-16994	SDS-MAX	180		1
P-17005	SDS-MAX	450		1
P-72338	SDS-PLUS	115		1
CENTRING				
P-03838	11	120	Pilot drill	1
P-03763			Drift key for all Core Bit Adaptors	1

FIXED LENGTH CORE BITS

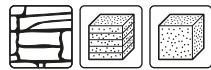
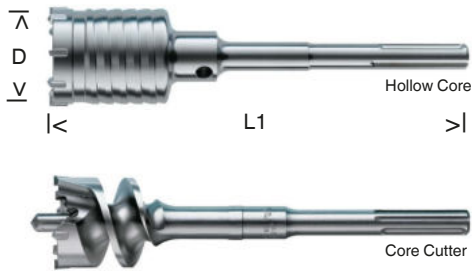

HOLLOW CORE				
P-25993	100	550		1
P-26004	125	550		1
P-26010	150	550		1
CONCRETE CORE CUTTER				
B-57635	45	550		1
B-57641	45	990		1
B-57657	55	550		1
B-57663	55	990		1
B-57679	65	550		1
B-57685	65	990		1
B-57691	80	550		1
B-57700	80	990		1

HOLLOW CORE BITS



ADAPTOR				
P-53914	30	190		1
EXTENSION SHAFT				
P-53920		320		1
P-53936		750		1
P-53942		1100		1

Extend your SDS-MAX Drills above 32mm diameter using the connector and extension shafts.

DRILLING: CHISEL AND POINTS

Part No.	D mm	L1 mm	L2 mm	Pack
----------	------	-------	-------	------

LONG LIFE SDS-PLUS



BULL POINT				
B-14037		250	190	1
COLD CHISEL				
B-14043	20	250	190	1

Long Life Chisels

New Makita SDS Steels have been through a performance enhancing change. Extra high resistance to wear and deformation has been achieved with induction hardening, extending efficient life time by 30%. Testing has shown material removal rates have also been increased by over 15%.



BULL POINT SDS-PLUS



D-19152		140	80	1
D-08034		160	100	1
D-08713		250	170	1
D-19015		400	340	1

COLD CHISEL SDS-PLUS



D-19168	20	140	80	1
D-08729	20	250	190	1
D-19021	20	400	340	1

SCALING CHISEL SDS-PLUS



D-08735	40	250	190	1
D-25616	50	250	190	1
D-61020	80	250	190	1
SELF SHARPENING				
B-14059	40	250	190	1
B-14065	60	250	190	1

GROOVING CHISEL SDS-PLUS



A-30075	8	170	110	1
---------	---	-----	-----	---

ANGLED TILE CHISEL SDS-PLUS



LONG LIFE				
B-14071	40	250	190	1

Batteries & Cases
Tool Holders
Drilling
Fixing
Saw Blades
Jigsaw & Recip
Multi Tool
Diamond
Bonded Abrasives
Flap Discs
Coated Abrasives
Router Cutters
Dust Extraction
Ground Maintenance

DRILLING: CHISEL AND POINTS

Part No.	D mm	L1 mm	L2 mm	Pack
CHANNEL CHISEL SDS-PLUS *****				
P-24963	22	12	250	1



SCRAPER ASSEMBLY SDS-PLUS *****				
343411-9	Blade only	100		1



WOOD CHISELS SDS-PLUS *****				
P-25105	20	170	110	1
P-25111	30	170	110	1



BULL POINT SDS-MAX *****				
---------------------------------	--	--	--	--

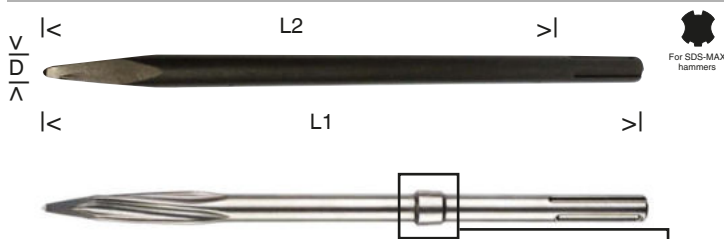

A-80787		280		1
D-34176		300	240	1
D-34182		400	320	1
D-34198		600	520	1

B-13823		280	220	1
B-13839		400	330	1
B-13845		600	520	1
SELF SHARPENING *****				
B-10366		400	330	1
B-23064*		400	330	1

Self Sharpening: 100h working with constant high removal rate without work interruption and jamming. Energy Rebound Technology

COLD CHISEL SDS-MAX *****				
----------------------------------	--	--	--	--

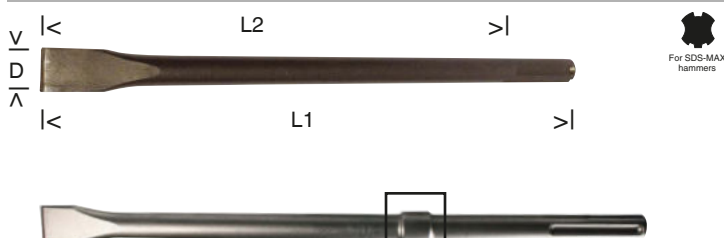

A-80802	25	280		1
D-34207	25	300	240	1
D-34213	25	400	330	1
D-34229	25	600	520	1

B-13851	25	280	220	1
B-13867	25	400	330	1
B-13873	25	600	520	1
SELF SHARPENING *****				
B-14009	25	400	330	1

Self Sharpening Energy Rebound Technology

SCALING CHISEL SDS-MAX *****				
-------------------------------------	--	--	--	--

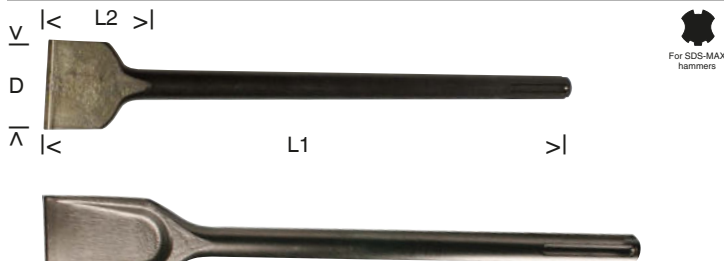

D-34235	50	400	190	1
D-34241	80	300	190	1

B-13889	50	400	190	1
B-13895	80	300	190	1
SELF SHARPENING *****				
B-14015	50	350	190	1

Self Sharpening

DRILLING: CHISEL AND POINTS

Part No.	D mm	L1 mm	L2 mm	Pack
----------	------	-------	-------	------

GROOVING CHISEL SDS-MAX

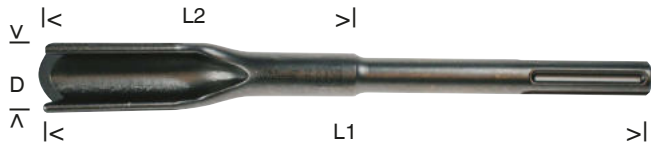

A-48555	22	280		1
B-13926	26	300	120	1

CHANNEL CHISEL SDS-MAX

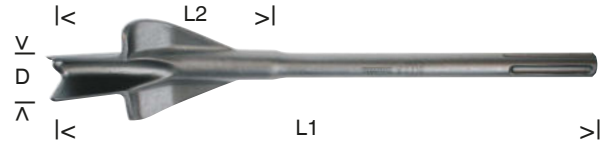

B-13948	35	380	190	1
---------	----	-----	-----	---

CHASING BRICK GOUGE SDS-MAX



B-13932	32	300	120	1
---------	----	-----	-----	---

MORTAR CHISEL SDS-MAX 9mm



B-13954	38	300		1
---------	----	-----	--	---

CURVED WIDE CHISEL SDS-MAX



B-13904	80	300		1
B-13910	115	350	190	1

ANGLED TILE CHISEL SDS-MAX



B-14021	50	300		1
---------	----	-----	--	---

BULL POINTS HEX SHANK

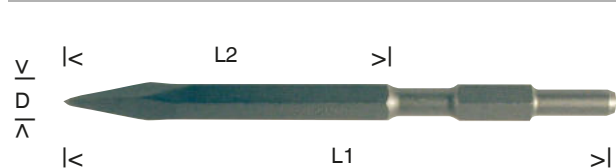

D-16374	17mm A/F	210	150	1
D-08682	17mm A/F	280	220	1
P-13035	17mm A/F	280	220	1
D-17631	28.6mm	410		1
D-16863	17mm A/F	450	360	1
P-13231	19mm A/F	300	220	1
P-13247	19mm A/F	380	320	1
P-13253	19mm A/F	460	380	1
P-13269	19mm A/F	600	520	1
P-05549	29mm A/F	410	330	1
D-15285	30mm A/F	400	320	1
A-80466	1 1/8"	400	320	1
P-05692	1 1/8"	400	320	1
P-46676	1 1/4"	380	300	1

Batteries & Cases
Tool Holders
Drilling
Fixing
Saw Blades
Jigsaw & Recip
Multi Tool
Diamond
Bonded Abrasives
Flap Discs
Coated Abrasives
Router Cutters
Dust Extraction
Ground Maintenance

DRILLING: CHISELS AND POINTS

		Part No.	Fitting	D mm	L mm	Pack
COLD CHISELS HEX SHANK *****						
		D-16879	17mm A/F	19	450	1
		D-08707	17mm A/F	19	280	1
		P-13063	17mm A/F	17	450	1
		A-80771	17mm A/F	17	280	10
		P-13275	19mm A/F	25	300	1
		P-13281	19mm A/F	25	380	1
		P-13297	19mm A/F	25	460	1
		P-13306	19mm A/F	25	600	1
		P-13487	29mm A/F	32	400	1
		D-15300	30mm A/F	30	400	1
		P-05723	1 1/8"	29	400	1
		P-46682	1 1/4"	25	380	1

		Part No.	Fitting	D mm	L mm	Pack
SCALING CHISELS HEX SHANK *****						
		B-07010	19mm A/F	50	220	1
		D-20694	17mm A/F	50	280	1
		P-13312	19mm A/F	70	300	1
		D-29228	28.6mm A/F	75	410	1
		D-23868	30mm A/F	75	310	1
		HK1800 ONLY				
		B-07004	12mm/19AF	20	220	1

		Part No.	Fitting	D mm	L mm	Pack
RAMMER *****						
		A-31485	29mm A/F	200	300	1

		Part No.	Fitting	D mm	L mm	Pack
CLAY SPADE *****						
		A-25214	17 A/F	105	400	1
		P-05468	19 A/F	120	500	1
		B-10300	30mm A/F	120	500	1
		P-05717	1 1/8"	125	400	1

MODEL NUMBER	MACHINE SHANK COMPATIBILITY						SDS-PLUS	SDS-MAX
	17mm HEX	19mm HEX	28.6mm HEX	29mm HEX	30mm HEX	1 1/4 HEX		
SCRAPERS								
HK1820 / HK1820L								•
HK0500								•
HK1820								•
DEMOLITION HAMMER								
HM0810T	•							
HM0870C / HM0871C								•
HM1203C / HM1213C								•
HM1214C								•
HM1101C / HM1111C								•
HM1304B				•			•	
HM1317C					•			
HM1317CB			•					
BREAKERS								
HM1800 / HM1810 / HM1810TR						•		
HM1812						•		
ROTARY HAMMER								
BHR262, BHR202, DHR202,								•
DHR241, DHR243, DHR263,								•
DHR264, DHR171Z, DHR182								•
HR2230, HR2470, HR2300,								•
HR2600, HR2601, HR2610,								•
HR2611, HR2811, HR2811FT,								•
HR2630, HR3210C, S-MAK32,								•
HR166DZ, HR140DZ,								•
HR2650, HR2651,								•
HR1840, HR1841F, HR140								•
DHR280, DHR281								•
HR3540C / HR3541FC								•
HR4013C								•
HR4001C / HR4011C								•
HR4511C								•
HR5212C								•
DHR400								•

DRILLING: CHISEL AND POINT SETS

SDS-PLUS CHISEL SET 3PC

D-42357



Content includes: Bull Point 250mm / Cold Chisel 250mm / Scaling Chisel 250mm

SDS-PLUS CHISEL SET 4PC

D-08757



Content include: Bull point 250mm / 2x Cold chisel 250mm

SDS-PLUS CHISEL SET 5PC

D-16368



Content includes: 2x Bull point 250mm / 2x Cold chisel 250mm / Scaling chisel 250mm

SDS-PLUS CHISEL SET 10PC

D-21191



Content includes: 5.5 x 110mm / 6 x 110mm / 7 x 160mm / 8 x 160mm / 10 x 210mm / 10 x 460mm / 16 x 460mm / 20 x 460mm / Bull point 250mm / Cold chisel 250 x 20mm

SDS-PLUS CHISEL SET 17PC

D-21200



Content includes: 5x 110mm, 5.5 x 110mm / 7x 160mm, 8 x 160mm / 10x 110mm, 10 x 210mm / 6x 110mm, 6 x 160mm / 8x 110mm, 8 x 210mm / 10x 160mm, 14 x 260mm / Bull point 140mm / Bull point 250mm / Cold chisel 140mm / Cold chisel 250mm / Scaling chisel 1x 250 x 40mm

SDS-MAX CHISEL SET 3PC

D-40543



Content includes: 1x Bull Point 400mm / 1x Cold chisel 400mm / 1x Scaling chisel 400mm

SDS-MAX CHISEL SET 4PC

D-40559



Content includes: Bull Point 300mm / Bull Point 400mm / Cold chisel 300mm / Cold chisel 400mm

SDS-MAX CHISEL SET 7PC

D-40571



Content includes: Bull point 400mm / Cold chisel 400mm / Scaling chisel 400mm / 4x TCT Drill 18x540, 20x540, 22 x 540, 25 x 540mm

DRILLING: TROLLY, HAMMER GREASE, DRILL STAND, MIXING BLADES

TROLLEY



Part No.	Details	Pack
D-26294	HM1800, HM1810	1
D-54972	HM1812, HM1810	1
D-26319	Tyre and pin set for trolleys	1



HAMMER GREASE



181490-7	30 gram	1
198993-4	100ml	1
183477-5	Hammer grease HR2450F/HR2432	1



DRILL STAND



Converts portable drill into a drill press.

43mm collar fits most modern drills.

A-36712	43mm Collar	1
---------	-------------	---



ANGLE DRILLING ATTACHMENT



STEX122177	6013 / 6300LR	1
193316-1	DA4000LR	1



MIXING BLADES

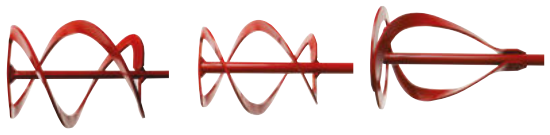
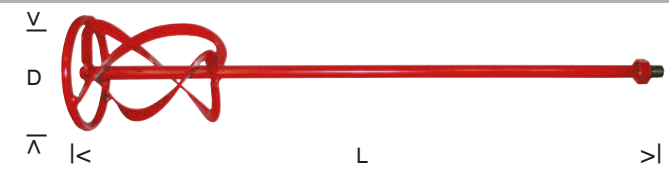

P-02347 <10kg 500W 600min⁻¹
 P-02353 <15kg 700W 500min⁻¹
 P-22012 <30kg 950W 500min⁻¹

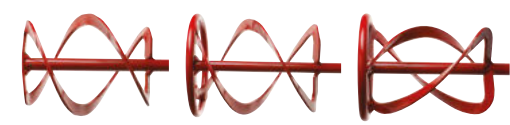

P-22028 15-30kg 800W 300-600upm
 P-22040 <30kg 1000W 400min⁻¹
 P-22056 25-40kg 800W 400-600upm



A-43717



A-43773

Part No.	Fitting	D2 mm	L mm	Pack
PLASTER				
P-02347	13mm	90	400	1
MORTAR				
P-02353	13mm	100	600	1
PAINT AND PLASTER				
P-22012	M14	120	590	1
PLASTER, MORTAR AND ADHESIVES				
P-22028	M14	100	590	1
MORTAR AND ADHESIVES				
P-22040	M14	135	590	1
PAINT AND MORTAR				
P-22056	M14	120	590	1
UT2204 - MIXING PADDLE				
A-43773	M8	Shaft		1
A-43717	M8	Blade		1



DRILLING: CHUCKS AND KEYS

Part No.	Details	Type	Pack
MAKLOK QUICK CHANGE CHUCKS SDS-PLUS *****			
	P-63725	SDS-PLUS Chuck	Hex 1
	B-57548	SDS-PLUS Sleeve chuck bit holder 80mm	Hex 1

Part No.	Key	Details	Model
CHUCKS AND KEYS *****			
CHUCKS			
192887-5	763418-3*	CHUCK 6.5MM	6501
193822-6	763430-3*	CHUCK S13	HP2070+F
763047-2		CHUCK S13	
192885-9	763415-9*	CHUCK S10	DA3000R,DA3010D
193318-7	763432-9*	DRILL CHUCK S-13	DA4000LR
193519-7	763432-9*	DRILL CHUCK S-13	DA4031
763114-3	763430-3*	DRILL CHUCK S13	HP204,HP1500
763115-1	763430-3*	DRILL CHUCK S13	8450,HP1500,HP1510
763174-5	763415-9*	DRILL CHUCK S13	DDA340,DDA350,DA3010,DA3010F,DA3011
766016-2	763430-3*	DRILL CHUCK S13	HR1640,HP1640,HR1640
CHUCK AND KEY SETS			
196008-1	763448-4	CHUCK AND KEY S13	HP1620/40
193442-6	763414-1	CHUCK AND KEY	DA3000R
192970-8	763418-3	CHUCK AND KEY S10	6012HD,601DST
CHUCK KEYS			
763432-9		CHUCK KEY S13	
763414-1		CHUCK KEY S10	
763415-9		CHUCK KEY S10	
763430-3		CHUCK KEY S13	
763418-3		CHUCK KEY S10	
763448-4		CHUCK KEY S13	
410102-8		CHUCK KEY S13	
411780-7		CHUCK KEY S10	6501, DA3010F, 301
450688-0		CHUCK KEY S10	BDA350, BDA340

*Key not included

Part No.	Details	Model
KEYLESS CHUCKS *****		
134561-9	CHUCK ASSY	HR2510
192121-3	KEYLESS CHUCK	6935+80D,TD101
194568-7	DRILL CHUCK SET	HR3210CT+FCT
196173-6	DRILL CHUCK SET	HR2611FT
196193-0	KEYLESS DRILL CHUCK	HP1500/8540,HP1621/1631/1641
766005-7	KEYLESS CHUCK 10	DDA341,DDA351
766027-7	KEYLESS DRILL CHUCK 13	DHP482
763248-2	KEYLESS DRILL CHUCK 13	BHP448
CHUCK MOUNT - 3/8 X 24UNF		
196308-9	KEYLESS CHUCK 10	DF330D
196309-7	KEYLESS DRILL CHUCK 10	DDF343
192016-0	KEYLESS CHUCK S10	6019D,6075D,6095D,6408,6410,DA302D,DA312D,DA392D
192891-4	KEYLESS CHUCK 13	6313D,6333D
CHUCK MOUNT - 1/2 X 20UNF		
193211-5	KEYLESS CHUCK 6.5MM	6503DWD
196307-1	KEYLESS CHUCK 10	6260/70/80D
196310-2	KEYLESS DRILL CHUCK 10	8271D
763187-6	KEYLESS DRILL CHUCK 10	8270D,8280D
196306-3	KEYLESS DRILL CHUCK 13	DDF453
194254-0	KEYLESS CHUCK	HP2031,2051+F,HP2071F
193616-9	KEYLESS CHUCK	6316D,6317D,6336D,6337D,6347D,DP4700
193550-3	KEYLESS CHUCK 13	8413D,8433D,8443D
194079-2	QUICK CHANGE DRILL CHUCK	DHR243,DHR262T,HR2450T,HR2470T,HR2611FT,HR2811FT
763199-9	KEYLESS DRILL CHUCK 13	6319D,6339D,6349D,8414D,8434D,8444D
763178-7	KEYLESS CHUCK 13	6390D,8390D
196311-0	KEYLESS CHUCK 13	DHP440,DDF452
763196-5	KEYLESS DRILL CHUCK 13	DDF441,DDF451,DHP441,DHP451
SDS-PLUS		
122574-2	DRILL CHUCK ASSY	HR2010,HR245
P-33788	KEYLESS CHUCK+SDS ADAPTOR	SDS MACHINE
P-34833	KEYED CHUCK ADPT AND KEY KIT	SDS MACHINE
763182-6	KEYLESS DRILL CHUCK S13 MT65	SDS MACHINE
763181-8	KEYLESS DRILL CHUCK S10 MT64	SDS MACHINE
1/4 HEX KEYLESS CHUCK		
194250-8	KEYLESS CHUCK	FOR 1/4 HEX MACHINES

Batteries & Cases
Tool Holders
Drilling
Fixing
Saw Blades
Recip
Jigsaw & Recip
Multi Tool
Diamond
Bonded Abrasives
Flap Discs
Coated Abrasives
Router Cutters
Dust Extraction
Ground Maintenance

Impact GOLD

Xtreme Torsion Technology



IMPACT GOLD TORSION BITS 50mm				
Part No.	Size	Details	Pack	*****
50mm Bits				
<p>50mm double torsion bit Impact Gold 50mm bit Impact Gold Standard bit</p>				
B-28167	PH1	50mm	2	
B-39160	PH2	50mm Double Torsion	2	
B-28189	PH3	50mm	2	
B-28276	PZ1	50mm	2	
B-39182	PZ2	50mm Double Torsion	2	
B-28298	PZ3	50mm	2	
B-28226	T10	50mm	2	
B-28232	T15	50mm	2	
B-28248	T20	50mm	2	
B-28254	T25	50mm	2	
B-28260	T30	50mm	2	
B-28195	SQ1	50mm	2	
B-28204	SQ2	50mm	2	
B-28210	SQ3	50mm	2	
B-28307	PH2	50mm Grip Wood Bit	2	
B-28313	PH2	50mm Enduro Bit	2	
B-62359	PH2	50mm Slim Torsion	2	
B-62365	PZ2	50mm Slim Torsion	2	
FLIPTOP BOX				
B-39528	PH2	50mm Double Torsion	10	
B-39540	PZ2	50mm	10	
B-39562	SQ2	50mm	10	

IMPACT GOLD 'SHORTON' BITS 30mm				
Part No.	Size	Details	Pack	*****
30mm ShorTon Bits				
<p>30mm double torsion bit Impact Gold 30mm bit Impact Gold Standard bit</p>				
B-42189	PH1	30mm	2	
B-42195	PH2	30mm Double Torsion	2	
B-42204	PH3	30mm	2	
B-42210	PZ1	30mm	2	
B-42226	PZ2	30mm Double Torsion	2	
B-42232	PZ3	30mm	2	
B-42248	T10	30mm	2	
B-42254	T15	30mm	2	
B-42260	T20	30mm	2	
B-42276	T25	30mm	2	
B-42282	T30	30mm	2	
B-42298	SQ1	30mm	2	
B-42307	SQ2	30mm	2	
B-42313	SQ3	30mm	2	
B-42329	HEX 2.5	30mm	2	
B-42335	HEX 3.0	30mm	2	
B-42341	HEX 4.0	30mm	2	

IMPACT GOLD TORSION BITS 25mm				
Part No.	Size	Details	Pack	*****
25mm Bits				
<p>IG 25mm bit+ IG Holder IG 25mm bit + Standard holder Standard bit</p>				
B-28329	PH1	25mm	2	
B-28335	PH2	25mm	2	
B-28341	PH3	25mm	2	
B-28444	PZ1	25mm	2	
B-28450	PZ2	25mm	2	
B-28466	PZ3	25mm	2	
B-28391	T10	25mm	2	
B-28400	T15	25mm	2	
B-28416	T20	25mm	2	
B-28422	T25	25mm	2	
B-28438	T30	25mm	2	
B-28363	SQ1	25mm	2	
B-28379	SQ2	25mm	2	
B-28385	SQ3	25mm	2	
B-28488	PH2	25mm Grip Wood Bit	2	
B-28503	PH2	25mm Enduro Bit	2	
B-62337	PH2	25mm Slim Torsion	2	
B-62343	PZ2	25mm Slim Torsion	2	
FLIPTOP BOX				
B-39512	PH2	25mm	15	
B-39534	PZ2	25mm	15	
B-39556	SQ2	25mm	15	

Part No.	Size	Details	Pack
----------	------	---------	------

MAGNETIC BIT HOLDER



A Magnetic Bit Holder which defies all standard magnetic holders. With 2x the magnetic force and extreme Torsion Technology, it is manufactured for strength and efficiency. Precision fit eliminate cam out and stripping.

*1/4" hex fitting

*Extreme Torsion Technology

*Convenience of one-handed fastening.

	B-28525	75mm	Torsion Bit Holder	1
	B-28531	71mm	Ultra-Mag Torsion Bit Holder	1

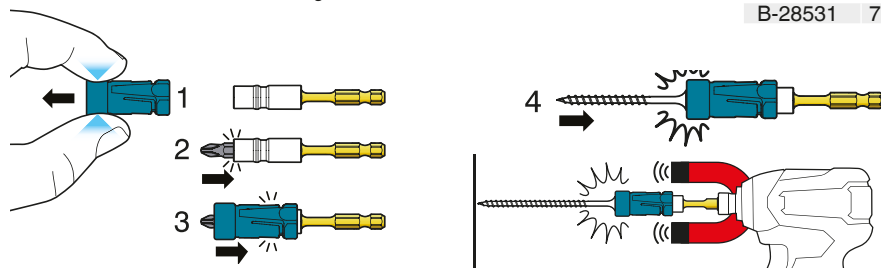

MAG BOOST

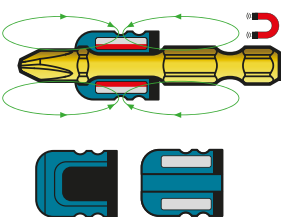

A bullet sized attachment to magnetize a screw bit allowing for instant magnetic screwdriving without the use of a holder

The Mag Boost offers 17X the magnetic force compared with a standard magnetic bit.

	B-42422		Mag Boost	1
	B-42472		Mag Boost + 5pc PZ2 50mm	1
	B-42488		Mag Boost + 5pc PH2 50mm	1
	B-42494		Mag Boost + 5pc T25 50mm	1
	B-42519		Mag Boost + 5pc SQ2 50mm	1
	B-42503		Mag Boost + 5pc PZ2x2, PH2x2, T25	1

IMPACT GOLD NUTSETTER



Ring Nutsetter

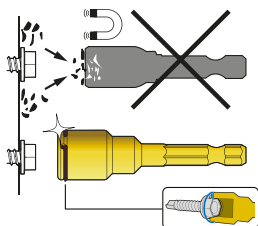

Quick and easy securing of screws without the build-up of metal debris. Non-magnetic ring grips.

Detachable Nutsetter

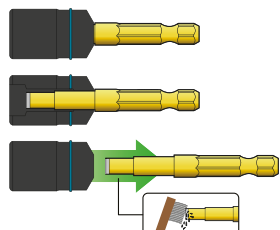

Separating the 2 parts of the holder allows direct access to the magnet meaning easy removal of swarf build-up. The socket piece and shank are each manufactured to optimal hardness, with improved breaking strength. This nutsetter has 20X the life compared with a standard nutsetter.

RING NUTSETTER			
B-28569	H8mm (5/16")	1	
B-28575	H9.6mm (3/8")	1	
B-28581	H10mm (7/16")	1	

DETACHABLE NUTSETTER			
B-40266	Hex 8mm (5/16")	1	
B-40272	Hex 9.6mm (3/8")	1	
B-40288	Hex 10mm (7/16")	1	
B-40353	Hex 8mm (5/16")	3	
B-40369	Hex 9.6mm (3/8")	3	
B-40375	Hex 10mm (7/16")	3	
B-40381	Hex 8, 9.6, 10mm	3	

TILT SOCKET ADAPTOR

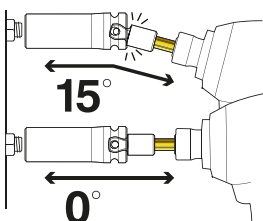

Impact Gold socket adaptors allows tilt action up to 15°. Heat treated alloy steel for extreme torque applications. The tilt action allows for working in confined spaces and engaging those hard to reach, against the wall fastens. Designed for impact drivers, impact wrenches and ratchets.

*1/4" Hex shank

*Available in 2 sizes

*Ideal for working in confined spaces

	B-28547	75mm	Tilt Socket Adaptor 75mm SQ3/8"	1
	B-28553	75mm	Tilt Socket Adaptor 75mm SQ1/2"	1

FIXING: IMPACT GOLD TORSION BITS

IMPACT GOLD TORSION BIT SET 11PC

B-28597

25mm
PH1, 2, 3
PZ1, 2, 3
T15, 20, 25, 30
Bit Holder



Impact GOLD

IMPACT GOLD ULTRA MAG SET 11PC

B-30754

25mm
PH1, 2, 3
PZ1, 2, 3
T15, T20, T25, T30
Ultra Mag Bit Holder

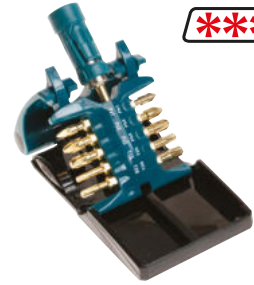

Impact GOLD

IMPACT GOLD BIT SET 38PC

B-54536

Detachable nut setter : 1x H 1/4", 1x H 5/16", 1x H 3/8, 1x Adapter. 1/4" Socket adapter Torsion bit holder Mag Boost Insert torsion bit (25mm): 1x Ph1, 3x Ph2, 1x Ph3, 1x Pz1, 3xPz2, 1x Pz3, 1x Sq1, 3x Sq2, 1x Sq3, 1x T20, 1x T25, 1x T30. Double-end torsion bit (65mm): 1x Pz2-T20, 1x Pz2-T25, 1x Pz2-T30, 1xPh2-Sq2, 1x Ph2-Ph2



Impact GOLD

IMPACT GOLD DOUBLE ENDED 10PC

B-52928-6

65mm PZ2 x 10

Master Carton: 6



Impact GOLD

IMPACT GOLD BIT SET 26PC

B-69163

20 x 25mm Screw bits
2 x 65mm Double-ended bit
2 x Magnetic nutsetters
1 x Torsion bit holder
1 x Mag boost



Impact GOLD

IMPACT

Impact driver's accessory series

BLACK

- For use with impact drivers
- Black coating prevents rusting
- High durability with longer life than standard bits

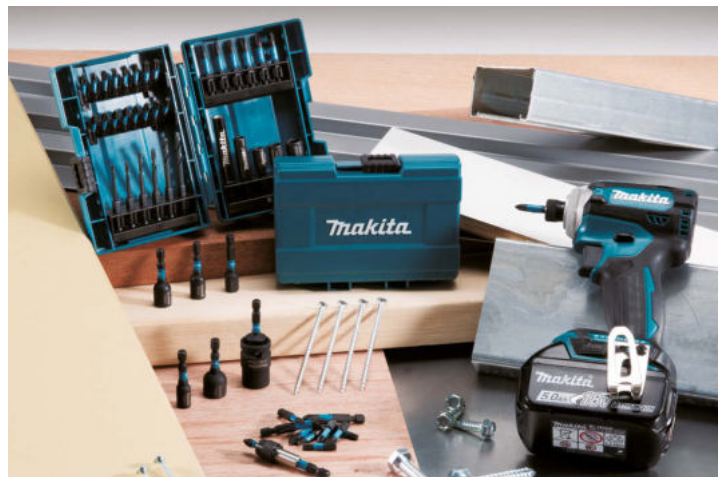

Part No.	Size	Details	Pack
----------	------	---------	------

IMPACT BLACK TORSION BITS 50mm



B-63719	PH1	1/4" Hex shank, 50mm	2
B-63725	PH2	1/4" Hex shank, 50mm	2
B-63731	PH3	1/4" Hex shank, 50mm	2
B-63747	PZ1	1/4" Hex shank, 50mm	2
B-63753	PZ2	1/4" Hex shank, 50mm	2
B-63769	PZ3	1/4" Hex shank, 50mm	2
B-63775	T15	1/4" Hex shank, 50mm	2
B-63781	T20	1/4" Hex shank, 50mm	2
B-63797	T25	1/4" Hex shank, 50mm	2
B-63806	T30	1/4" Hex shank, 50mm	2
B-63812	T40	1/4" Hex shank, 50mm	2

IMPACT BLACK TORSION BITS 25mm



B-63600	PH1	1/4" Hex shank, 25mm	2
B-63616	PH2	1/4" Hex shank, 25mm	2
B-63622	PH3	1/4" Hex shank, 25mm	2
B-63638	PZ1	1/4" Hex shank, 25mm	2
B-63644	PZ2	1/4" Hex shank, 25mm	2
B-63650	PZ3	1/4" Hex shank, 25mm	2
B-63666	T15	1/4" Hex shank, 25mm	2
B-63672	T20	1/4" Hex shank, 25mm	2
B-63688	T25	1/4" Hex shank, 25mm	2
B-63694	T30	1/4" Hex shank, 25mm	2
B-63703	T40	1/4" Hex shank, 25mm	2

IMPACT BLACK TORSION NUTSETTERS



B-66824	6mm	Magnetic, 1/4" Hex shank, 50mm	1
B-66830	8mm	Magnetic, 1/4" Hex shank, 50mm	1
B-66846	10mm	Magnetic, 1/4" Hex shank, 50mm	1
B-66852	13mm	Magnetic, 1/4" Hex shank, 50mm	1

IMPACT BLACK TORSION DRIVER ADAPTOR



B-66868		3/8" Drive adapter	1
B-66874		1/2" Drive adapter	1

IMPACT BLACK TORSION HOLDER / CHUCK / GUIDE



B-66793

B-66818

B-66802

B-66793		Mag Bit Holder	1
B-66818		Screw Guide	1
B-66802		Sleeve Chuck	1

IMPACT BLACK BIT SET 33PC

B-66896

- 16x 25mm Screw Bits
- 6x 50mm Screw Bits
- Magnetic Nutsetter 6, 8, 10mm
- Magnetic Bit Holder
- 1/4" HSS Twist Drill 2.5, 3, 3.5, 4, 4.5, 5mm
- Screw Guide Holder



Batteries & Cases
Tool Holders
Drilling
Fixing
Saw Blades
Jigsaw & Recip
Multi Tool
Diamond
Bonded Abrasives
Flap Discs
Coated Abrasives
Router Cutters
Dust Extraction
Ground Maintenance

FIXING: TORSION BITS, SCREWDRIVER BITS

Part No.	Size	L mm	Pack

B-20703	PH2	65	3
B-20719	PZ2	65	3
B-20725	PZ3	65	3
B-20731	PZ3	85	3
B-12790	PZ2	85	3
B-12326	PH2	85	3
B-16259	PZ2	85	18

TORSION BITS

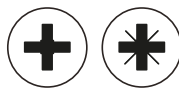

Longer lasting torsion bits for impact drivers

The high torque produced by impact drivers will damage standard screwdriver bits but the new Makita double ended torsion screwdriver bit out performs beyond all expectations, lasting up to 10 times longer than a standard bit.

- For continuous high torque fastening with impact drivers.
- Ideal for self-drilling metal screws and long wood screws.



B-16259

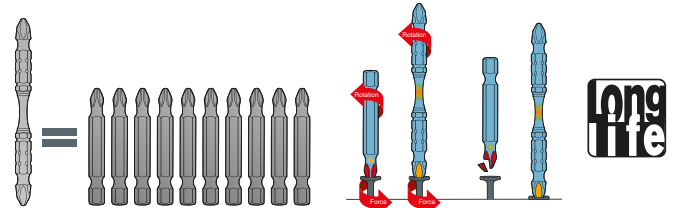

SLOT BIT 25mm



P-17902	5.5 x 0.8mm	25	5
P-17918	6.0 x 1mm	25	5
P-17924	7.2 x 1.2mm	25	5

PHILLIPS BIT 25mm



P-47933	PH1	25	5
P-47949	PH2	25	5
P-47955	PH3	25	5

POZI BIT 25mm



P-47961	PZ1	25	5
P-47977	PZ2	25	5
P-47983	PZ3	25	5

STAR BIT 25mm



P-48050	T8	25	5
P-48066	T9	25	5
P-48072	T10	25	5
P-48088	T15	25	5
P-48094	T20	25	5
P-48103	T25	25	5
P-48119	T27	25	5
P-48125	T30	25	5
P-48131	T40	25	5

PHILLIPS BIT TITANIUM 25mm



TITANIUM



P-47994	PH1	25	5
P-48000	PH2	25	5
P-48016	PH3	25	5

POZI BIT TITANIUM 25mm



TITANIUM



P-48022	PZ1	25	5
P-48038	PZ2	25	5
P-48044	PZ3	25	5

























STAR BIT TITANIUM 25mm



TITANIUM



P-48147	T8	25	5
P-48153	T9	25	5
P-48169	T10	25	5
P-48175	T15	25	5
P-48181	T20	25	5
P-48197	T25	25	5
P-48206	T27	25	5
P-48212	T30	25	5
P-48228	T40	25	5

		Part No.	Size	L mm	Pack	
NUT DRIVER 50mm *****						
 <p>< L ></p>	 	P-48717	5	50	1	
		P-48723	5.5	50	1	
		P-48739	6	50	1	
		P-48745	7	50	1	
		P-48751	8	50	1	
		P-48767	9	50	1	
		P-48773	10	50	1	
		P-48789	10	65	1	
		P-48795	13	50	1	
		P-48804	13	65	1	
		P-48810	17	50	1	
P-48826	17	65	1			
MAGNETIC NUT DRIVER SET 4PC 48mm B-57554						
<p>8 x 48mm 10 x 48mm 12 x 48mm 13 x 48mm</p>	 					*****
DOUBLE ENDED BITS 45-150mm *****						
 <p>< L ></p>	 	P-48701	PH1/Slotted	48	5	
		784207-3	PH2	150	1	
		784210-4	PH3	110	1	
		134873-0	Bit Adaptor	33	1	
SLOT BIT 50mm *****						
 <p>< L ></p>	 	P-48913	0.5 x 4mm	50	5	
		P-48929	0.6 x 3.5mm	50	5	
		P-48935	0.8 x 4mm	50	5	
		P-48941	0.8 x 5.5mm	50	5	
		P-48957	1 x 5.5mm	50	5	
		P-48963	1.2 x 6.5mm	50	5	
		P-48979	1.2 x 8mm	50	5	
		P-48985	1.6 x 8mm	50	5	
		P-48991	1.6 x 10mm	50	5	
PHILLIPS BIT 50mm *****						
 <p>< L ></p>	 	P-48402	PH1	50	5	
		P-48418	PH2	50	5	
		P-48424	PH3	50	5	
POZI BIT 50mm *****						
 <p>< L ></p>	 	P-48430	PZ1	50	5	
		P-48446	PZ2	50	5	
		P-48452	PZ3	50	5	
STAR BIT 50mm *****						
 <p>< L ></p>	 	P-48527	T8	50	5	
		P-48533	T9	50	5	
		P-48549	T10	50	5	
		P-48555	T15	50	5	
		P-48561	T20	50	5	
		P-48577	T25	50	5	
		P-48583	T27	50	5	
		P-48599	T30	50	5	
		P-48608	T40	50	5	
HEX BITS 50mm *****						
 <p>< L ></p>	 	P-73396	4	50	5	
		P-73461	5	50	5	
		P-73477	6	50	5	
		P-73483	7	50	5	
		P-73499	8	50	5	

FIXING: SCREWDRIVER BITS

Part No.	Size	L mm	Pack
----------	------	------	------

PHILLIPS BIT TITANIUM 50mm



TITANIUM



P-48468	PH1	50	5
P-48474	PH2	50	5
P-48480	PH3	50	5

POZI BIT TITANIUM 50mm



TITANIUM



P-48496	PZ1	50	5
P-48505	PZ2	50	5
P-48511	PZ3	50	5

STAR BIT TITANIUM 50mm



TITANIUM



P-48614	T8	50	5
P-48620	T9	50	5
P-48636	T10	50	5
P-48642	T15	50	5
P-48658	T20	50	5
P-48664	T25	50	5
P-48670	T27	50	5
P-48686	T30	50	5
P-48692	T40	50	5

E-FORM SCREW BITS



Long length drill bit with a 1/4" Hex shank for hard to reach areas. Designed with a rounded bar so it will not damage the work area.



B-57772	PH1	90	1
B-57788	PH2	90	1
B-57794	PH3	90	1
B-57803	SQ1	90	1
B-57819	SQ2	90	1
B-57825	SQ3	90	1
B-59879	PZ1	90	1
B-59885	PZ2	90	1
B-59891	PZ3	90	1
B-59900	T15	90	1
B-59916	T20	90	1
B-59922	T25	90	1
B-59938	T30	90	1
B-57831	PH1	150	1
B-57847	PH2	150	1
B-57853	PH3	150	1
B-57869	SQ1	150	1
B-57875	SQ2	150	1
B-57881	SQ3	150	1
B-59944	PZ1	150	1
B-59950	PZ2	150	1
B-59966	PZ3	150	1
B-59972	T15	150	1
B-59988	T20	150	1
B-59994	T25	150	1
B-60006	T30	150	1

SLIM TOUGH BIT PH0



A high quality bit with a slim shaft for precise work allowing the user to operate in narrow and obscure spaces. Automobile maintenance, electrical equipment. Not for use with Impact Drivers. Made in Japan.

B-42575	PH0	85mm	1
---------	-----	------	---

BIT HOLDERS



SCREWDRIVER BITS			
P-51982	Magnetic	75	1
784811-8	Magnetic /C-clip	60	1
784604-3	Non-Magnetic /C-clip	75	1
B-57750	Magnetic bit holder 150mm		1
B-57766	Magnetic bit holder 300mm		1
1/2" SQ DRIVE AND 1/4" HEX IMPACT WRENCH BITS			
134873-0	6900DW	33	1

FLEXIBLE BIT HOLDER



B-51867	Flexible Tough bit holder		1
---------	---------------------------	--	---

FIXING: SCREWDRIVER BITS

SCREW GUIDE P-46274

1x Screw guide 120mm
2x 25mm PZ1, PZ2



STUBBY SCREW GUIDE P-46268

1x Stubby guide 80mm
2x 25mm PZ1, PZ2
1x 25mm slotted 6-8



CLEAR SCREW GUIDE P-46280

1x Screw guide 120mm
2x 25mm PZ2
1x 25mm slotted 8-10



SCREW GUIDE SET 10PC P-46296

1x Clear screw guide 120mm
1x Stubby guide 80mm
8x Screw bits 25mm
3x PZ1, 2, 3
3x PH1, 2, 3
2x Slot 4-6, 8-10



Part No.	Size / Type	L mm	Pack
----------	-------------	------	------

BIT CATCHER E-FORM ****



B-54411	Magnetic		1
---------	----------	--	---

QUAD DRIVERS ****



PROFESSIONAL 4 WAY DRIVER			
P-70611	No. 6		1
P-70627	No. 8		1
P-70605	No. 10		1
PILOT DRILL REPLACEMENT 4 WAY			
P-50289	No. 6		5
P-50295	No. 8		5
P-50304	No. 10		5

PROFESSIONAL 4 WAY DRIVER SET 10PC P-70633

No. 6, 8, 10, 12
25mm PH0, PH1, PH2, PH3



PROFESSIONAL 4 WAY DRIVER SET 28PC P-70552

4-way drivers - pilot drill, countersink, counter bore and screwdriver with tool. Includes a range of popular 25mm screwdriver bits. Sizes 6,8,10,12



HINGE GUIDES ****



P-70574	No. 6		1
P-70580	No. 8		1
P-70596	No. 10		1

PROFESSIONAL HINGE GUIDE SET 11PC P-70568

4x Hinge guides: 6, 8, 10, 12mm
2x 25mm bits: PZ1, PZ3
4x Slotted 4, 5, 6, 7mm
1x 4 Way Driver Barrel



QUICK CHANGE COUNTERSINK SET 4PC P-51954

No. 6, 8, 10, 12



FIXING: AUTOFEED SCREWDRIVERS

Part No.	Size	Model	L mm	Pack
AUTOFEED SCREWDRIVER EXTENSION HANDLE *****				
192501-3		6831/6832/6833/6834/6837		1
194500-1		DFR440/DFR550/DFR750/6843/6844		1

Part No.	Size	Model	L mm	Pack
AUTOFEED ATTACHEMENT FOR DRYWALL SCREWDRIVER *****				
199146-8		Autofeed Attachment		1
Screwdriver Bits for 199146-8				
140B28-9		PH2 130mm		1
140B35-2		SQ 130mm		1
199155-7		PHT 130mm		5

Part No.	Size	Model	L mm	Pack
AUTOFEED SCREWDRIVER BITS *****				
5mm				
P-66232	PH2	DFR440	117	10
P-66248	PH2	6832/6833/6835/6837	127	10
P-66254	PH2	6834	141	10
P-66260	PZ2	BFR440	117	10
P-66276	PZ2	6832/6833/6835/6837	127	10
P-66282	PZ2	6834	141	10
P-67773	PZ2	DFR550/6843	157	3
P-67789	PZ2	DFR750/6844	177	3
P-67795	PH2	DFR550/6843	157	3
P-74697	PH2	DFR550	160	3
P-67804	PH2	DFR750/6844	177	3
P-72752	SQ	DFR550/6843	157	10
P-72746	SQ	DFR750/6844	177	10
6mm				
P-43898	PH2	6830/6831	110	10
P-63959	PH2	BFR440	117	10
P-43907	PH2	6832/6833/6835/6837	127	10
P-43913	PH2	6834	141	10
P-43929	PZ2	6830/6831	110	10
P-63965	PZ2	BFR440	117	10
P-43935	PZ2	6832/6833/6835/6837	127	10
P-43941	PZ2	6834	141	10



Compatible with plastic collated screws. Accepts screw size 25-55mm. Includes 2 x 130mm PH2 bits. Compatible models: DFS452, DFS250, FS6300, FS4300, FS4000, FS2300.



IDENTIFYING AUTOFEED SCREWDRIVER BIT SIZES
Autofeed screw drivers produced after the serial numbers shown on the right use 5mm screw driver bits, this is clearly marked on the barrel of the machine. Models prior to these serial numbers use 6mm screw driver bits.

6832	Serial No. 65446E
6833	Serial No. 65446E
6834	Serial No. 94007E
6835D	Serial No. 65446E
6836	Serial No. 65446E
6837	Serial No. 65446E
BFR440	Serial No. 65446E

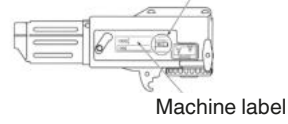

Part No.	Type	Model	Gauge	Coating	Thread	Size mm	Per Strip	Screws	Pack
COLLATED SCREWS *****									
DRY WALL SCREWS DIN 18182 BLACK PHOSPHATE									
F-30913	PH2	DFR550/6843/6833/6834/6835/DFR440	3.9	Phosphate	Fine	25	50	1000	20
F-31153	PH2	DFR550/6843/6833/6834/6835/6836/DFR440	3.9	Phosphate	Fine	35	50	1000	20
F-31182	PH2	DFR550/6843/6833/6834/6835/6836/DFR440	3.9	Phosphate	Coarse	41	50	1000	20
F-31140	PH2	DFR550/6843/6833/6834/6835/6836	3.9	Phosphate	Coarse	55	50	1000	20
STAINLESS STEEL									
F-32351	Square	DFR750/6844	4.2	Stainless	Coarse	65	50	1000	20
YELLOW ZINC									
F-33199	Square	DFR550/6843	4.2	Yellow Zinc	Coarse	35	50	1000	20
F-33205	Square	DFR750/6844	4.2	Yellow Zinc	Coarse	45	50	1000	20
F-33221	Square	DFR750/6844	4.2	Yellow Zinc	Coarse	50	50	1000	20
F-33234	Square	DFR750/6844	4.2	Yellow Zinc	Coarse	55	50	1000	20
F-33247	Square	DFR750/6844	4.2	Yellow Zinc	Coarse	60	50	1000	20
F-33250	Square	DFR750/6844	4.2	Yellow Zinc	Coarse	65	50	1000	20
F-33263	Square	DFR750/6844	4.2	Yellow Zinc	Coarse	75	50	1000	20
WEATHER X									
F-33308	Square	DFR750/6844	4.2	Weather X	Coarse	50	50	1000	20
F-33311	Square	DFR750/6844	4.2	Weather X	Coarse	55	50	1000	20
F-33337	Square	DFR750/6844	4.2	Weather X	Coarse	65	50	1000	20
F-33353	Square	DFR750/6844	4.2	Weather X	Coarse	75	50	1000	20

Black phosphate collated screws for dry wall applications in steel and wood. Manufactured to DIN1812 certified to 48 hour salt spray test. High quality non jamming tapes.

Stainless steel collated screws for a traditional finish suitable for restoration work and areas where hygienic non-maintenance fixing is required. Moisture and chemical resistant ideal for outdoor use, long life, maintenance free A2 stainless steel.

Yellow zinc plated with square drive for decking use. High pullout strength hold fast in hard or soft woods, MDF and chipboard.

Weather X green coating for decking and external construction. Square drive for high torque applications. Weather X coating is resistant to most wood preservatives and tested to 1000 hour salt spray test.

FIXING: SCREWDRIVERS / SOCKETS

SHOCK DRIVERS

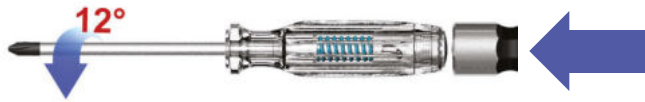

This is a hand tool driver to allow users to remove stripped screws that cannot be rotated by machine tool.

Cam rotation mechanism is built in and converts the impact to driver head hit by a hammer into a turning force. In short, stripped screws can be removed by applying push and torque at the same time.

Quick removal of crushed or stripped screws.

Part No.	Size	L mm	Pack
B-42438	PH2	125	1
B-42444	PH3	150	1
B-42450	PZ2	125	1
B-42466	PZ3	150	1

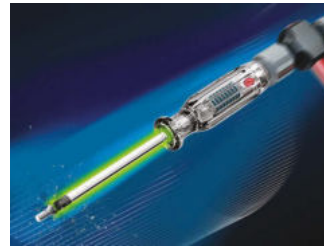

THREADED ROD SOCKET



1/4" HEX SET 3PC

- B-42961 - 6mm
- B-42977 - 8mm
- B-42983 - 10mm



Part No.	D mm	L mm	Pack	Pin	O-Ring
1/4" HEX					
B-42961	6		1		
B-42977	8		1		
B-42983	10		1		

Threaded rod is often used for supporting air conditioning units, lights, piping and cables on the ceiling or the wall.

The Threaded Rod Socket greatly reduces time and effort compared with tightening the rod by hand.

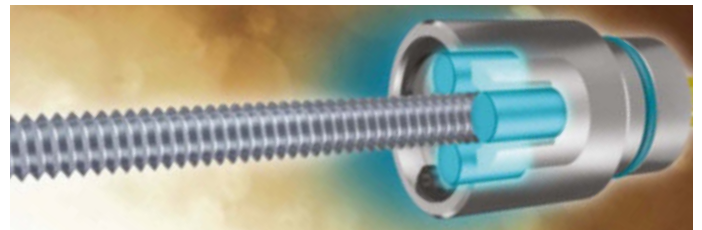

IMPACT SOCKETS

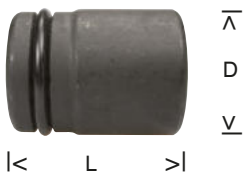

1/2" SQUARE DRIVE SET 9PC

- 5/16", 11/16", 3/4"
- 8, 10, 13, 17, 19, 21mm

Master Carton: 8



1" SQUARE DRIVE					
134872-2	41	80	1	256284-0	213570-2
134865-9	36	80	1	256284-0	213570-2
134864-1	35	80	1	256284-0	213570-2
1/2" SQUARE DRIVE					
134867-5	12	75	1	268057-9	213397-0
134827-7	13	52	1	268057-9	213397-0
134826-9	14	38	1	268057-9	213396-2
134828-5	14	52	1	268057-9	213397-0
134831-6	19	38	1	268057-9	213398-8
134832-4	19	52	1	268057-9	213398-8
134837-4	19	80	1	268057-9	213399-6
134838-2	21	41	1	268057-9	213399-6
134833-2	21	52	1	268057-9	213398-8
134839-0	21	80	1	268057-9	213399-6
134851-0	22	42	1	268057-9	213399-6
134840-5	23	43	1		
134835-8	23	43	1		
134841-3	24	43.5	1	268057-9	213399-6
134836-6	24	52	1	268057-9	213398-8
134842-1	26	45	1	268057-9	213399-6
134843-9	26	75	1		
133301-2	27	75	1	268057-9	213399-6
134846-3	30	47	1	268057-9	213399-6
134847-1	30	75	1	268057-9	213399-6
134848-9	32	48	1	268057-9	213399-6
134849-7	32	75	1	268057-9	213399-6
3/4" SQUARE DRIVE					
134853-6	26	53	1	213514-2	256282-4
134854-4	26	100	1	213514-2	256282-4
134855-2	27	53.5	1	213514-2	256282-4
134856-0	27	100	1	213514-2	256282-4
134857-8	30	52	1	213514-2	256282-4
134858-6	30	100	1	213514-2	256282-4
134871-4	32	56	1	213514-2	256282-4
134859-4	32	100	1	213514-2	256282-4
134860-9	35	58	1	213514-2	256282-4
134861-7	35	95	1	213514-2	256282-4
134862-5	36	59	1	213514-2	256282-4
134863-3	36	95	1	213514-2	256282-4

FIXING: SOCKETS

CR-MO IMPACT SOCKETS



A premium Impact Socket Set with 1/2" Drive. Made from high strength Chrome Molybdenum Alloy Steel offering a combination of endurance and impact resistance.

CR-MO 1/2" SQUARE DRIVE 9PC SET

D-41517

8, 10, 13, 16, 17, 18, 19, 21, 24mm

Socket with O-ring and Pin



CR-MO 1/2" SQUARE DRIVE 9PC SET

B-54645

8, 10, 12, 13, 14, 15, 17, 18mm

Square drive socket



CR-MO 3/8" SQUARE DRIVE 9PC SET

B-54651

8, 10, 12, 13, 14, 15, 17, 18mm

Square drive socket



EXTENSION BAR



Part No.	D mm	L mm	Pack	Pin	O-Ring
----------	------	------	------	-----	--------

CR-MO 1/2" SQUARE DRIVE

B-40054	8	38	1	268056-1	213396-2
B-40060	9	38	1	268056-1	213396-2
B-40076	10	38	1	268056-1	213396-2
B-40082	11	38	1	268056-1	213396-2
B-40098	12	38	1	268056-1	213396-2
B-40107	13	38	1	268056-1	213396-2
B-40113	14	38	1	268056-1	213396-2
B-40129	15	38	1	268056-1	213396-2
B-40135	16	38	1	268056-1	213396-2
B-40141	17	38	1	268056-1	213370-0
B-40157	18	38	1	268057-9	213398-8
B-40163	19	38	1	268057-9	213398-8
B-40179	20	38	1	268057-9	213399-6
B-40185	21	38	1	268057-9	213399-6
B-40191	22	38	1	268057-9	213399-6
B-40200	23	38	1	268057-9	213399-6
B-40216	24	38	1	268057-9	213399-6
B-40222	27	42	1	268057-9	213399-6
B-40238	30	44	1	268057-9	213399-6
B-40244	32	44	1	268057-9	213399-6

CR-MO 3/8" SQUARE DRIVE

B-39883	6	28	1		
B-39899	7	28	1		
B-39908	8	28	1		
B-39914	9	28	1		
B-39920	10	28	1		
B-39936	11	28	1		
B-39942	12	28	1		
B-39958	13	28	1		
B-39964	14	28	1		
B-39970	15	28	1		
B-39986	16	28	1		
B-39992	17	30	1		
B-40004	18	30	1		
B-40010	19	30	1		
B-40026	20	30	1		
B-40032	21	30	1		
B-40048	22	30	1		

CR-MO 1/2" SQUARE DRIVE 7PC SET

B-69733

13, 17, 19, 21, 22, 24mm

Square drive socket



Part No.	Shank	Size	Pack
----------	-------	------	------

134874-8	1/2"	84mm 1/2"	1
B-55706	1/2"	250mm	1
B-55712	1/2"	150mm	1
B-55728	1/2"	75mm	1
134997-2	3/4"	150mm 6"	1

UNIVERSAL JOINTS



134877-2	1/2"	100mm 4"	1
134998-0	3/4"	150mm 6"	1

SQUARE DRIVE SOCKET ADAPTOR



B-54667	3/8" Square	50mm 1/4"	1
B-54673	3/8" Square	50mm 1/4"	1
B-57738	3/8" Square	150mm 6"	1
B-57744	3/8" Square	150mm 6"	1
P-51839	1/4" Hex to Square	50mm 1/4"	1
P-51845	1/4" Hex to Square	50mm 1/4"	1
B-68448	1/2" Squ to 1/4" Hex		1

FIXING: SOCKETS, DRYWALL, CAULKING GUN

DRYWALL SCREWDRIVER BITS



Part No.	Size	Pack
DRYWALL DRIVER BITS		
P-47949	PH2	5
P-47955	PH3	5
P-47977	PZ2	5
P-47983	PZ3	5

MAGNETIC BIT HOLDER



Part No.	Size	L1 mm
DRYWALL DRIVER BITS		
784811-8	1/4"	60
784801-1	1/4"	76

LOCATOR ASSEMBLIES FOR DEPTH SETTING



Part No.	Type	Model
FRONT CAP AND LOCATORS		
158875-2	Short	FS6300, FS4300, FS2300, FS4200
158876-0	Long	FS6300, FS4300, FS2300, FS4200
122867-7	Short	FS2500
122868-5	Long	FS2500

SOCKET BITS



Part No.	Bolt Size	Size	L mm	Model
MAGNETIC BIT HOLDER				
784803-7	1/8"	1/4"	65	FS2700, FS2500, 6802BV, 6805, 6807
784804-5	3/16"	5/16"	65	FS2700, FS2500, 6802BV, 6805, 6807
784802-9	1/4"	3/8"	65	FS2700, FS2500, 6802BV, 6805, 6807
784806-1	M6	10mm	65	FS2700, FS2500, 6802BV, 6805, 6807
784805-3	1/2"	7/16"	65	FS2700, FS2500, 6802BV, 6805, 6807
NON MAGNETIC BIT HOLDER				
784415-6	M5	8mm	65	FS2700, FS2500, 6802BV, 6805, 6807
784414-8*	1/2"	7/16"	65	FS2700, FS2500, 6802BV, 6805, 6807

* Bi-hex bit

LOCATOR ASSEMBLIES FOR DEPTH SETTING



Part No.	Size	Type	Model
FRONT CAP AND LOCATORS			
322124-5	1/4"	Front cap	FS2700
450963-4	1/4"	Locator	FS2500
322125-3	5/16"	Front cap	FS2700
450967-6	5/16"	Locator	FS2500
322119-8	3/8"	Front cap	FS2700
450968-4	3/8"	Locator	FS2500
322126-1	7/16"	Front cap	FS2700
FRONT CAP AND LOCATORS			
322125-3	5/16"	Front cap	FS2700
450967-6	5/16"	Locator	FS2500
322126-1	7/16"	Front cap	FS2700

Part No.

Details

DRYWALL GUIDE BITS



193447-6	6.35mm (single bit)
191G68-0	3.18mm (pack of 5)

CAULKING GUN HOLDERS FOR DCG140 / DCG180



196351-8	300ml Holder - BCG140/180
196352-6	600ml Holder - BCG140/180
454275-7	300ml Holder - DCG180
141861-0	600ml Holder - DCG180
454226-0	Nozzle

GREASE GUN



P-90451	Grease gun (without hose)
P-90489	24" Grease gun hose

REBAR TYING ACCESSORIES



Tying Bit



Wire Set (100m Reel)

194731-2	Tying Bit - 1/4" Hex Shank
199137-9	Wire Set for DTR180 (100m x 50 reels)
191J59-9	Poly Coated Tie Wire Set



Handi-Pack Nails for the GN900SE Gas Nailer



Handi-Pack Tub of 1000pc for GN900SE gas framing nailer. Gas cells included (x1).

Reusable container made from freeze-grade plastic so it will not become brittle in cold weather. All Handi-Pack nails are manufactured to Eurocode 5 / EN14592 specification.

EUROCODE 5

It is a mandatory requirement to use CE-Marked fasteners for making structural connections in timber constructions.

Fasteners must meet the requirements of EN1995 Eurocode 5. Failure to comply with these regulations will be a breach of european law.

MAKITA NAILS ARE (EC5) EUROCODE 5 CERTIFIED WHERE NECESSARY AND MARKED WITH THE RELEVANT SERVICE CLASS.

	SERVICE CLASS 1 INDOORS
	SERVICE CLASS 2 INDOOR NOT HEATED OR OUTDOOR PROTECTED
	SERVICE CLASS 3 OUTDOOR EXPOSED TO WEATHER

NAILS FOR AIR NAILERS



34 Degree Paper Collated Framing Nails



15 Gauge Angle Finishing Nails

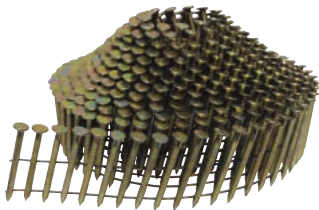

Galvanised Ring Coil Nail

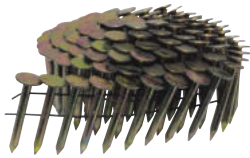

Galvanised Smooth Coil Nails



16 Gauge Brads



18 Gauge Brads

Part No.	Model	D mm	Shank	L mm	Finish	Pack	Service Class	Gas

34 DEGREE PAPER COLLATED FRAMING NAILS								
P-45783	AN943	2.8	Ring	50	Galvanised	3300	2	
P-45799	AN943	2.8	Ring	63	Galvanised	3300	2	
P-45808	AN943	3.1	Ring	75	Galvanised	2200	2	
P-45814	AN943	3.1	Smooth	90	Galvanised	2200	2	
15 GAUGE ANGLE FINISHING NAILS								
P-45820	AF633	3.1	Smooth	32	Galvanised	4000		
P-45836	AF633	3.1	Smooth	38	Galvanised	4000		
P-45842	AF633	3.1	Smooth	50	Galvanised	4000		
P-45858	AF633	3.1	Smooth	64	Galvanised	4000		
GALVANISED RING COIL NAIL								
P-51437	AN504	2.1	Ring	27	Galvanised	16000		
P-51443	AN504	2.1	Ring	32	Galvanised	16000		
P-51459	AN504	2.1	Ring	38	Galvanised	16000		
P-51465	AN504	2.1	Ring	45	Galvanised	16000		
P-51471	AN504	2.1	Ring	50	Galvanised	16000		
P-51487	AN611	2.5	Ring	45	Galvanised	9000		
P-51493	AN611	2.5	Ring	50	Galvanised	9000		
P-51502	AN611	2.5	Ring	64	Galvanised	9000		
P-51524	AN901	2.8	Ring	64	Galvanised	5000		
P-51530	AN901	2.8	Ring	75	Galvanised	5000		
P-51552	AN901	3.1	Ring	90	Galvanised	4500		
GALVANISED SMOOTH COIL NAIL								
P-51546	AN901	3.1	Smooth	90	Galvanised	4500		
16 GAUGE BRADS								
F-33890	AF600, DBN600	1	Smooth	15	Galvanised	2000		
F-33906	AF600, DBN600	1	Smooth	19	Galvanised	2000		
F-33922	AF600, DBN600	1	Smooth	25	Galvanised	2000		
F-33948	AF600, DBN600	1	Smooth	32	Galvanised	2000		
F-33964	AF600, DBN600	1	Smooth	38	Galvanised	2000		
F-33980	AF600, DBN600	1	Smooth	45	Galvanised	2000		
F-33993	AF600, DBN600	1	Smooth	50	Galvanised	2000		
F-34027	AF600, DBN600	1	Smooth	64	Galvanised	2000		
18 GAUGE BRADS								
P-45923	AF505, DBN500	1	Smooth	20	Galvanised	5000		
P-45939	AF505, DBN500	1	Smooth	25	Galvanised	5000		
P-45945	AF505, DBN500	1	Smooth	30	Galvanised	5000		
P-45951	AF505, DBN500	1	Smooth	40	Galvanised	5000		
P-45967	AF505, DBN500	1	Smooth	50	Galvanised	5000		

NAILS FOR GAS NAILER GN900



It is Makita's aim to continually develop the quality of our products in line with stringent demands of industry. This is why all Makita nail gas packs are already EC5 rated (Eurocode 5). The EC5 and European standards are effective from 1st July 2013 and are applicable to all suppliers of fixings used in timber construction.



Handi-Pack

MODEL GN900SE								
P-77045	GN900SE	2.9	Ring	50	Bright	4000	1	4
P-77132	GN900SE	3.1	Ring	76	Bright	2000	1	2
P-77160	GN900SE	3.1	Smooth	90	Bright	2000	1	2
P-77051	GN900SE	2.9	Ring	50	Galvanised	4000	2	4
P-77067	GN900SE	2.9	Ring	65	Galvanised	4000	2	4
P-77089	GN900SE	3.1	Ring	65	Galvanised	3000	2	3
P-77110	GN900SE	2.9	Ring	76	Galvanised	2000	2	2
P-77148	GN900SE	3.1	Ring	76	Galvanised	2000	2	2
P-77176	GN900SE	3.1	Smooth	90	Galvanised	2000	2	2
P-77073	GN900SE	2.9	Ring	65	Hot dip galv	4000	3	4
P-77095	GN900SE	3.1	Ring	65	Hot dip galv	4000	3	4
P-77154	GN900SE	3.1	Ring	76	Hot dip galv	2000	3	2
P-77182	GN900SE	3.1	Smooth	90	Hot dip galv	2000	3	2
MODEL GN900SE - HANDI PACKS								
P-80818	GN900SE	2.9	Ring	50	Galvanised	1000	2	1
P-80824	GN900SE	2.9	Ring	65	Galvanised	1000	2	1
P-80830	GN900SE	3.1	Ring	65	Galvanised	1000	2	1
P-80846	GN900SE	3.1	Ring	76	Galvanised	1000	2	1
P-80852	GN900SE	3.1	Smooth	90	Galvanised	1000	2	1

NAILS FOR GAS NAILER GF600



MODEL GF600								
195667-8	GF600	1	Smooth	15	Galvanised	2000		2
195668-6	GF600	1	Smooth	19	Galvanised	2000		2
195670-9	GF600	1	Smooth	25	Galvanised	2000		2
195672-5	GF600	1	Smooth	32	Galvanised	2000		2
195674-1	GF600	1	Smooth	38	Galvanised	2000		2
195676-7	GF600	1	Smooth	45	Galvanised	2000		2
195677-5	GF600	1	Smooth	50	Galvanised	2000		2
195680-6	GF600	1	Smooth	64	Galvanised	2000		2

Batteries & Cases
Tool Holders
Drilling
Fixing
Saw Blades
Jigsaw & Recip
Multi Tool
Diamond
Bonded Abrasives
Flap Discs
Coated Abrasives
Router Cutters
Dust Extraction
Ground Maintenance

FIXING: NAILS AND STAPLES

PINS FOR GAS NAILER GN420



C6 pins suitable for concrete substrate <25Nm



HC6 pins suitable for harder steel concrete substrate >25Nm



40 Shot Magazine Assembly

Part No.	Model	D mm	Shank	L mm	Finish	Pack	Service Class	Gas
C6 PINS FOR STANDARD CONCRETE (<25Nm) SUBSTRATES								
196290-2	GN420	2.6	Smooth	20	Galvanised	1000	1	
196291-0	GN420	2.6	Smooth	25	Galvanised	1000	1	
196292-8	GN420	2.6	Smooth	30	Galvanised	1000	1	
196293-6	GN420	2.6	Smooth	35	Galvanised	1000	1	
196294-4	GN420	2.6	Smooth	40	Galvanised	1000	1	
HC6 PINS FOR HARD CONCRETE (>25Nm) AND STEEL SUBSTRATES								
196285-5	GN420	3.1	Smooth	15	Zinc plated	1000	1	
196286-3	GN420	3.1	Smooth	17	Zinc plated	1000	1	
196287-1	GN420	3.1	Smooth	22	Zinc plated	1000	1	
196288-9	GN420	3.1	Smooth	27	Zinc plated	1000	1	
196289-7	GN420	3.1	Smooth	32	Zinc plated	1000	1	
40 SHOT MAGAZINE ASSEMBLY FOR GN420								
196805-5	GN420				40 Shot Magazine Assembly		1	

NAILS FOR HIGH PRESSURE NAILERS



Part No.	Model	D mm	Shank	L mm	Finish	Pack
MODELS AN610H, AN611, AN620H, AN621, AN711H, AN911H, AN901						
F-30810		2.5	Smooth	45	Bright	10800
F-30865		2.5	Screw	50	Bright	10800
F-31243		2.5	Smooth	50	Bright	10800
F-30878		2.5	Screw	57	Bright	8100
F-31256		2.5	Smooth	57	Bright	8100
F-30900		2.5	Smooth	65	Bright	8100
F-31269		2.5	Screw	65	Bright	8100
MODELS AN620H, AN621, AN711H, AN901, AN911H						
F-30823		2.8	Smooth	50	Bright	9000
F-30849		2.9	Smooth	50	Bright	9000
F-30971		2.9	Screw	50	Bright	9000
F-31272		2.9	Screw	57	Bright	6750
F-30881		2.9	Screw	65	Bright	6750
F-30836		3.1	Smooth	65	Bright	6750
F-30852		3.3	Smooth	65	Bright	4050
MODELS AN711H, AN901, AN911H						
F-31285		2.9	Screw	73	Bright	6750
F-31298		3.1	Smooth	75	Bright	4050
F-31320		3.2	Screw	75	Bright	4050
F-31359		3.4	Smooth	75	Bright	3600
MODELS AN901, AN911H						
F-31304		3.1	Smooth	85	Bright	4050
F-31333		3.1	Screw	85	Bright	4050
F-31317		3.1	Smooth	90	Bright	4050
F-31346		3.2	Screw	90	Bright	4050
F-31362		3.8	Smooth	90	Bright	2700
MODELS AN510, AN610H, AN611						
F-32766		2.1	Smooth	32	Bright	21600
F-32779		2.1	Smooth	38	Bright	18000
F-32782		2.1	Smooth	45	Bright	18000
F-32795		2.1	Smooth	50	Bright	14400
MODELS AN610H, AN611						
F-32801		2.1	Screw	38	Bright	18000
F-32814		2.1	Screw	45	Bright	18000
F-32827		2.1	Screw	50	Bright	14400

PINS FOR PIN NAILERS

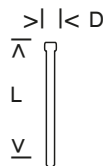
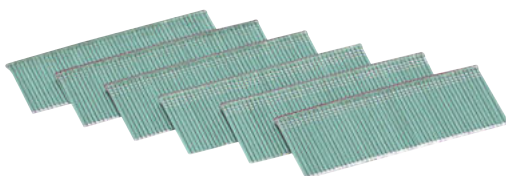

Part No.	Model	D mm	Shank	L mm	Finish	Pack
23G HEADLESS PINS						
P-51568	AF201Z	0.6	Smooth	12	Bright	20000
P-51574	AF201Z	0.6	Smooth	15	Bright	20000
P-51580	AF201Z	0.6	Smooth	18	Bright	20000
P-51596	AF201Z	0.6	Smooth	22	Bright	20000
P-51605	AF201Z	0.6	Smooth	25	Bright	20000
23G HEADLESS PINS						
F-31825	DPT350,DPT353	0.6	Smooth	P18	Bright	10000
F-31838	DPT350,DPT353	0.6	Smooth	P25	Bright	10000
F-31841	DPT350,DPT353	0.6	Smooth	P30	Bright	10000
F-31854	DPT350,DPT353	0.6	Smooth	P35	Bright	10000
STAINLESS STEEL 23G HEADLESS PINS						
F-32142	DPT350,DPT353	0.6	Smooth	P18S	Stainless	10000
F-32155	DPT350,DPT353	0.6	Smooth	P25S	Stainless	10000
F-32168	DPT350,DPT353	0.6	Smooth	P30S	Stainless	10000
F-32171	DPT350,DPT353	0.6	Smooth	P35S	Stainless	10000

FIXING: STAPLES, AIR, GAS, RIVET GUN

Part No.	Model	D mm	Shank	L mm	Finish	Pack
----------	-------	------	-------	------	--------	------

STAPLES FOR AIR STAPLERS

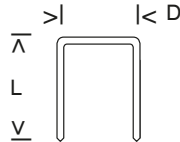

18G GALVANISED TYPE 90 NARROW CROWN STAPLE						
P-45864	AT638	6	Smooth	15	Bright	5000
P-45870	AT638	6	Smooth	18	Bright	5000
P-45886	AT638	6	Smooth	25	Bright	5000
P-45892	AT638	6	Smooth	30	Bright	5000
P-45901	AT638	6	Smooth	35	Bright	5000
P-45917	AT638	6	Smooth	38	Bright	5000

STAPLES FOR CORDLESS STAPLERS

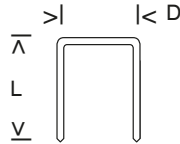

MODELS BTS110, ST113						
F-81518		7	Smooth	10	Bright	25,000
F-81521		10	Smooth	10	Bright	15,000
MODELS DST221						
F-32647		10	Smooth	10	Bright	5040
F-32650		10	Smooth	13	Bright	5040
F-32663		10	Smooth	16	Bright	5040
F-32676		10	Smooth	19	Bright	5040
F-32689		10	Smooth	22	Bright	5040

Part No.	Details	Pack
----------	---------	------

AIR TOOL ACCESSORIES



P-45973	15 x 8mm Hose with 1/4" Couplings	1
P-45989	1/4" Hi Flow Tail Piece	1
181434-7	Service Oil for Pneumatic tools 30cc	1
B-80014	15m High pressure hose	1
6011400036	Spiral Hose 10m for MAC610	1

GAS NAILER CLEANING KIT

194852-0

Contains lint free cloth, cleaner, oil, brush, allen key 4mm, cleaning instructions.



GAS NAILER OIL

242077-1

Makita lubricating oil specially formulated for gas nailers. (Size 100ml)



GAS NAILER CLEANER

242075-5

Makita gas nailer cleaning spray suitable for all gas nailers. (Size 500ml)



GAS NAILER GAS CELL

242094-1

High performance gas with clean combustion and fully synthetic oil suitable for most first fix gas nailers.

Cell for GN420CSE and GN900SE



GAS NAILER GAS CELL

242088-6

High performance gas with clean combustion and fully synthetic oil suitable for most first fix gas nailers.

Cell for GF600SE



Part No.	Details	Pack
----------	---------	------

RIVET GUN ACCESSORIES



191C03-4



199729-4



199728-6



191C04-2



199725-2

191C03-4	Set B for 4.8 - DRV250	1
191C04-2	Set B for 4.0 - DRV150	1
199729-4	Set for 2.4 - DRV150	1
199728-6	Set for 3.2 - DRV150	1
199725-2	Set for 6.0 - DRV250	1

Batteries & Cases
Tool Holders
Drilling
Fixing
Saw Blades
Jigsaw & Recip
Multi Tool
Diamond
Bonded Abrasives
Flap Discs
Coated Abrasives
Router Cutters
Dust Extraction
Ground Maintenance

227PC GENERAL MAINTENANCE TOOL SET

P-90532

Complete home repair kit for most jobs. This is a versatile tool and accessory kit in a quality carry case for a work site or a garage. Comprising of 227 pieces it contains all the parts necessary to complete the job to the highest standards.



- Wrench 6/8/10/11/12/13/14/15/16/17/18/19mm
- Folding Hex key wrench 1.5 - 8mm
- Bit driver with magnetic tip
- 1/4" 72T & 1/2" 72T Ratchet handle
- 1/4" Socket 4/4.5/5/5.5/6/7/8/9/10/11/12/13/14mm
- 1/2" Socket 15/16/17/19/20/21/22/24/27/30/32mm
- 1/4" Coupler
- 1/4" 4/5/6/7/8mm
- 3/8" 10/11/12/14/16/18mm
- 1/2" 20/22/24mm
- 1/2" 16/21mm
- 1/4" Spinner handle
- 1/4" Extension bar 2" & 4", 1/2" Extension bar 5" & 10"
- 1/4" Sliding T-Bar
- 1/2" x 3/8" 3 Way socket adapter
- 1/4" & 1/2" Universal Joint
- Nutsetter 5/5.5/6/7/8/9/10/11/12/13mm
- 30mm Screwdriver bits SL6/6.5/8, T25/27/30/35/40X2/45/50, (With Hole: T27/30/35/40/45/50), PH1/PH2/PH3X2/PH4X2, PZ1/PZ2/PZ3X2/PZ4X2
- 25mm Screwdriver bits SL3/4/5/6, T8/9/10/15/20x5PCS/25x4PCS/27x4PCS/30/40, (With hole T8/9/10/15/20/25/27/30/40), PH1/PH2/PH3/PH4, PZ0x2PCS/PZ1x2PCS/PZ2x3PCS/PZ3x3PCS, (With hole H3x2PCS/H4x2PCS/H5x3PCS/H6x3PCS), PH0x5PCS/PH1x5PCS/PH2x5PCS/PH3x5PCS, Spanner: 5/6/8mm, Spline: 4/6/8mm, Troq: 6/8/10, Tri-wing: 1/2/3
- 60mm & 80MM Magnetic holder, 120mm Flexible Magnetic holder
- Socket adaptor 1/2"
- Coupler 1/2" X 5/16"



118PC MAINTENANCE TOOL SET

P-90635

Complete repair kit for most jobs. This is a versatile tool and accessory kit in a quality carry case for a work site or a garage. Comprising of 118 pieces to complete the job to the highest standards.



- 60mm Magnetic Holder
- Flexible Magnetic Holder (80mm & 120mm)
- 50x25mm Screwdriver bits
- 7 Combination Wrenches (8, 10, 11, 12, 13, 14, 15mm)
- 8 Hex Key Wrench 1.5mm-8mm
- 2x50mm Bit Adapter
- 13x1/4" DR Socket 4-14mm
- 14x 3/8" dr Socket 8-21mm
- 1/4" dr. Coupler
- 5x 1/4" dr. E-socket
- 6x 3/8" dr. socket
- 2x 1/2" dr. Spark plug socket 16 & 21mm
- 1/4" dr. Spinner handle
- 2x 3/8" dr. Extension bar 3" & 6"
- 1/4"M to 3/8" F socket adapter
- 1/2"M to 3/8" F 3 way socket adapter
- 3/8" dr. Universal Joint
- 3/8" dr. Ratchet handle



• Master carton quantities are for dealer use, all list prices are for individual sets (1-piece) except where stated by description.

125PC SERVICE ENGINEERS KIT

P-70649

Kit contains a carefully selected range of heavy duty sockets, ratchets and service tools required to service electrical and domestic appliances.



Master Carton: 2

91PC SERVICE ENGINEERS KIT

P-46470

Socket and bit set, especially designed for boiler and central heating engineers. This kit ensures that all the most commonly used sockets, bits and hexagon wrenches are available in one well proven set.

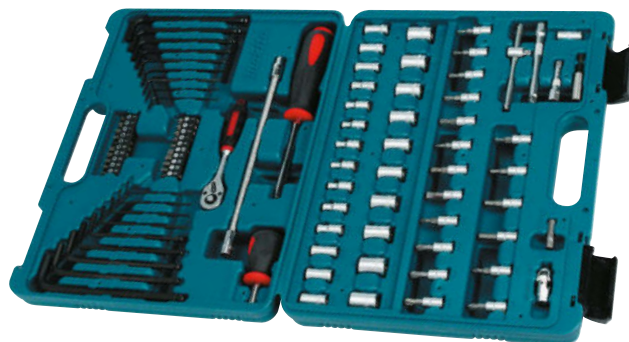

Master Carton: 6

79PC TECHNICIAN'S POUCH

P-52065

Specially designed for the workshop or mobile technician. Supplied in smart and convenient zip-up pouch. This kit includes long length screwdriver bits for easier access to deep seated screws. HSS and Masonry drill bits for general applications.



Master Carton: 10

96PC ELECTRICIAN'S POUCH

P-51851

A comprehensive set designed for the professional electrician. Includes pliers, insulated screwdrivers (VDE 1000v rated), precision screwdrivers and a selection of power tool accessories.



Master Carton: 6

• Master carton quantities are for dealer use, all list prices are for individual sets (1-piece) except where stated by description.

Batteries & Cases
Tool Holders
Drilling
Fixing
Saw Blades
Jigsaw & Recip
Multi Tool
Diamond
Bonded Abrasives
Flap Discs
Coated Abrasives
Router Cutters
Dust Extraction
Ground Maintenance

DRILLING AND FIXING: BIT SETS

MAKPAC 71PC DRILL & BIT SET

B-51699

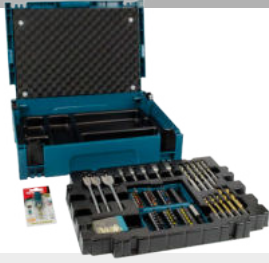

Content includes: 25mm Screw bits: PZ0/PZ1/PZ2/PZ3/PH0/PH1/PH2/PH2/PH3/T10/T15/T15/T20/T20/T25/T25/T27/T30/T30/SLO.5X4/SLO.6X4.5/SL1.0X5.5/SL1.0X6.5/ST10/ST15/ST20/ST25/ST27/ST30/ST40/Hex3/Hex4/Hex5/Hex6. HSS-TiN metal drill bit: 4/5/6/8/10. Hex shank flat bit: 16/20/25. Masonry drill bit: 5.5/6/7/8/10. 50mm Screw bits: PZ2 x5/PH2 x5 in flip top case. Nutsetter: 6/8/10/12/13. 25mm Impact Gold bits: PZ2 x15 in flip top case. Impact Gold Ultra Mag Torsion Bit Holder, Quick change 1/4" hex shank, Magnetic bit holder.

120PC PRO-XL KIT ALUMINIUM CASE

P-90277



Content includes: 40x 25mm + 20x 50mm Screwdriver bits, 5x Flat bits, 4x Holesaws, 10x 4-10mm HSS bits, 10x 3-10mm Masonry bits, 8x 4-10mm Brad point bits, 8x 6-13 Nutdriver bits.

Master Carton: 4

MAKPAC 69PC DRILL & BIT SET

B-49638



Content includes: 25mm Screw bits: PZ0/PZ1/PZ2/PZ3/PH0/PH1/PH2/PH2/PH3/T10/T15/T15/T20/T20/T25/T25/T27/T30/T30/SLO.5X4/SLO.6X4.5/SL1.0X5.5/SL1.0X6.5/ST10/ST15/ST20/ST25/ST27/ST30/ST40/Hex3/Hex4/Hex5/Hex6. HSS-G metal drill bit: 3/4/5/6/8. Wood drill bit: 3/4/5/6/8. Masonry drill bit: 5.5/6/7/8. Hex shank flat bit: 16/20. 50mm Screw bits: PZ2 x5/ PH2 x5 in flip top case. Nutsetter: 6/8/10/12/13. Magnetic bit holder.

70PC PRO-XL KIT ALUMINIUM CASE

P-90261



Content includes: 20x 25mm + 10x 50mm Screwdriver bits, 5x Flat bits, 8 x 2-8mm HSS bits, 10x 4-10mm Masonry bits, 6x 4-10mm Brad points.

Master Carton: 6

MAKPAC 66PC DRILL & BIT SET

B-43044



Content includes: 25mm Screw bits: PZ0/PZ1/PZ2/PZ3/PH0/PH1/PH2/PH2/PH3/T10/T15/T15/T20,T20,T25/T25/T27/T30/T30/SLO.5X4/SLO.6X4.5/SL1.0X5.5/SL1.0X6.5/ST10/ST15,ST20,ST25/ST27/ST30/ST40/Hex3/Hex4/Hex5/Hex6. HSS-G metal drill bit: 4/5/6/8/10. Wood drill bit: 4/5/6/8/10. Hex shank flat bit: 16/20/25. 50mm Screw bits: PZ2x5/PH2x5. Nutsetter: 8/10/12/13. Magnetic bit holder

40PC PRO-XL KIT ALUMINIUM CASE

P-90255



Content includes: 10x 25mm Screwdriver bits, 4x 10-22mm Brad points, 8x 2-8mm HSS bits, 10x 4-10mm Masonry bits.

Master Carton: 6

40PC 1/4" DRIVE SOCKET SET

P-90283

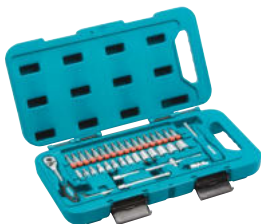

Content includes: 1/4" Ratchet handle, 1/4" Drive sockets x13, 1/4" Drive coupler, 1/4" Screwdriver bit sockets x17, T-Bar, extension bar 50 and 100mm.

Master Carton: 10

40PC FLAT BIT SET

P-90299



Content includes: 6mm x2 ,8mm x5,10mm x5,12mm x3, 13mm, 14mm, 16mm x3, 18mm x4,19mm, 20mm, 22mm x5, 25mm x5, 29mmx2, 32mm x2.

Master Carton: 10

• Master carton quantities are for dealer use, all list prices are for individual sets (1-piece) except where stated by description.

DRILLING AND FIXING: BIT SETS

120PC PRO KIT P-90370

PRO



Content include: 60x 25mm Screwdriver bits, 14x Nutdriver bits, 4x Holesaws, 3x Wood boring bits, 7x 3-10mm Brad point bits, 13x 3-8mm HSS bits, 6x 5-10mm Masonry drill bits.

Master Carton: 4

100PC TRADE KIT P-90249

TRADE



Content includes: 30x 25mm + 20x 50mm Screwdriver bits, 3 Flat bits, 4x Holesaws, 6x 4-7mm Brad point bits, 6x 4-7mm Masonry bits, 6x 4-7mm HSS bits, 13x 4-13mm, 5/16 1/4 3/16 Nutdriver bits.

Master Carton: 12

105PC PRO KIT P-90364

PRO



Content includes: 40x 25mm +20 x 50mm Screwdriver bits, 7x 7-13mm Nutdriver bits, 3x Flat bits, 6x 3-8mm Brad point bits, 13x 3-8mm HSS bits, 6 x 5-8mm Masonry bits.

Master Carton: 6

75PC TRADE KIT P-90233

TRADE



Content includes: 40x25mm Screwdriver bits, 3 Flat bits, 4x Holesaws, 6x 4-7mm Brad Point bits, 6x 4-7mm Masonry bits, 6x 4-7mm HSS bits, 7x 6-13mm Nutdriver bits.

Master Carton: 10

60PC PRO KIT P-90358

PRO



Content includes: 30x 25mm Screwdriver bits, 6x 3-8mm Brad point bits, 5x 5-8mm Masonry bits, 7x 2-5mm HSS bits, 8x 5-13mm Nutdriver bits.

Master Carton: 12

50PC TRADE KIT P-90227

TRADE



Content includes: 10x 25mm + 10x 50mm Screwdriver bits, 3 Flat bits, 6 x 4-7mm Brad point bits, 6x 4-7mm Masonry bits, 6x4-7mm HSS bits, 7x 6-13mm Nutdriver bits.

Master Carton: 10

40PC MASONRY SET P-90314



Content includes: 3 x2, 3.5, 4, 4.5 , 5 x5, 5.5 x 6 , 6 x4 , 6.5 x 6, 7 x6, 8 x2, 8.5, 9, 9.5, 10 x2.

Master Carton: 10

• Master carton quantities are for dealer use, all list prices are for individual sets (1-piece) except where stated by description.

Batteries & Cases
Tool Holders
Drilling
Fixing
Saw Blades
Jigsaw & Recip
Multi Tool
Diamond
Bonded Abrasives
Flap Discs
Coated Abrasives
Router Cutters
Dust Extraction
Ground Maintenance

DRILLING AND FIXING: BIT SETS

216PC DRILL AND SCREWDRIVER BIT SET

P-44046

A thoroughly proven kit that represents outstanding value for money. Features: 216 piece drill bit set containing a wealth power tool accessories.



- 42 x HSS Drill Bits (4 x 1mm, 4 x 1.5mm, 5 x 2mm, 5 x 2.5mm, 5 x 3mm, 4 x 3.2mm, 4 x 3.5mm, 5 x 4mm, 1 x 4.5mm, 1 x 5mm, 1 x 5.5mm, 1 x 6mm, 1 x 6.5mm, 1 x 7mm, 1 x 7.5mm, 1 x 8mm, 1 x 9mm, 1 x 10mm).
- 11 x Masonry Bits (3, 4, 4.5, 5, 5.5, 6, 6.5, 7, 8, 9, 10mm).
- 2 x 300mm long Masonry Bits (8, 10mm).
- 8 x Brad Point Bits (2 x 4mm, 5mm, 6mm, 7mm, 8mm, 9mm, 10mm).
- 5 x Flat Wood Bits (10, 12, 16, 20, 22mm).
- 2 x 300mm long Flat Wood Bits (12, 14mm).
- 52 x 50mm Screwdriver Bits: 8 x Pozzi: (2 x PZ0, 2 x PZ1, 2 x PZ2, 2 x PZ3); 13 x Philips Bits (3 x PH0, 3 x PH1, 4 x PH2, 3 x PH3); 8 x Torx (T10, T15, T20, T25, T27, T30, T40, T45); 17 Slotted (2 x 3mm, 3 x 4mm, 3 x 5mm, 3 x 6mm, 3 x 7mm, 3 x 8mm). 6 x Hex (3, 4, 5, 6, 7, 8mm).
- 52 x 25mm Screwdriver Bits: 13 x Slotted (2 x 3mm, 2 x 4mm, 2 x 5mm, 2 x 5.5mm, 2 x 6mm, 2 x 7mm, 2 x 8mm). 13 x Philips (3 x PH0, 3 x PH1, 4 x PH2, 3 x PH3). 7 x Pozzi (PZ0, 2 x PZ1, 2 x PZ2, 2 x PZ3). 9 x Torx (T10, T15, T20, T25, T27, T30, T35, T40, T45). 6 x Hex (3, 4, 5, 6, 7, 8mm). 4 x Square (S1, 2, 3, 4).
- 20 x Nut Drivers (5, 5.5, 6, 7, 8, 9, 10, 11, 12, 13mm + 5/32", 3/16", 7/32", 1/4", 9/32", 5/16", 11/32", 3/8", 7/16", 1/2").
- 3 x depth gauges (3, 5, 6mm).
- 1 x allen key 2.5mm
- 1 x countersink
- 4 x holesaws, black finish (32, 38, 44, 54mm)
- 1 x holesaw arbor
- 3.5m measuring tape
- 1 x 8" spirit level
- 1 x T-shaped screwdriver handle with magnetic tip
- 2 x pencils
- 1 x flexible drive
- 2 x nail sets (1.5, 2.5mm)
- 1 x bit driver with magnetic tip, snap on handle

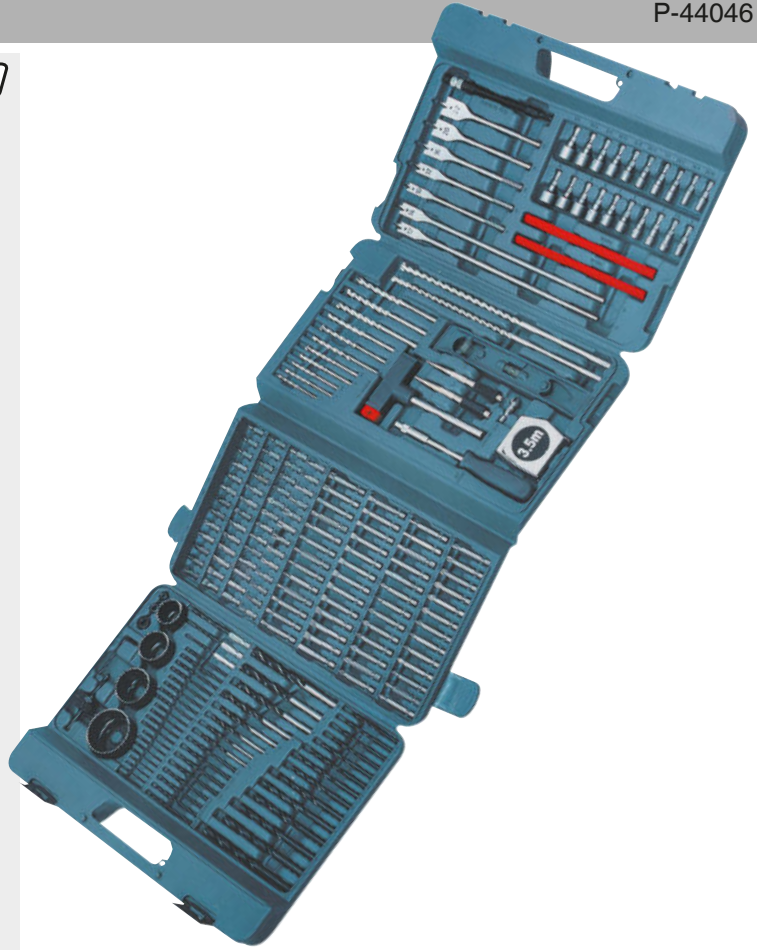

Master Carton: 3

100PC DRILL AND SCREWDRIVER BIT SET

B-53811

- Flat wood bits:** 12, 16mm
- 3-Point wood drill bits:** 3 x2, 4, 5 x2, 6, 8mm
- Masonry drill bits:** 6 x2, 7, 8mm
- HSS drill bits:** 2, 3 x2, 4, 5, 6mm
- 50mm Screwdriver bits:** PH1, PH2 x3, PH3, PZ1, PZ2 x3, PZ3, T20, T30
- 25mm Screwdriver bits:** T10, T15, T20, T25, T30, T40, PH1 x2, PH2 x3 PH3 x2, PZ1 x2, PZ2 x11, PZ3 x2, SL4, SL4.5, SL5, SL7, H4, H5, H6, H7, Tic-Tac tub 25mm PZ2 x25
- Holesaws:** 32, 38mm and Holesaw arbor
- Nutsetter:** 6, 8, 10mm
- Countersink and Magnetic bit holder



Master Carton: 8



104PC DRILL AND SCREWDRIVER BIT SET

P-71065

Premium quality mixed set. Very useful set for most drilling and fixing jobs. Titanium drill bits that last longer and cut faster. Robust case with metal hinges and clasps.



Master Carton: 4



• Master carton quantities are for dealer use, all list prices are for individual sets (1-piece) except where stated by description.

DRILLING AND FIXING: BIT SETS

75PC DRILL AND SCREWDRIVER BIT SET

B-49373

Wood drill bit: 4,5,6,8
Masonry drill bit for brick: 4,5,6,7,8
HSS-TIN Metal drill bit: 1,1.5,2,2.2,2.5,3,3,3.5,4,4,4.5,5,5.5,5.5,6,6.5,7,7.5,8
50mm Screw bits: PH1,PH2,PH3,PZ1,PZ2,PZ3
 SL1.0X5.5,SL1.2X6.5,T20,T25,T30,T40,H3,H4,H5,H6
25mm Screw bits: PZ0,PZ1,PZ2,PZ3,PH0,PH1,PH2,PH2,PH3,T10,T15,T20,T25,T30,SL0.5X3,SL0.5X4,SL0.6X5,SL1.0X6,SL1.0X6
Nutsetter: 5,5.5,6,7,8,9,10,11
 1/2" Countersink bit, Centre punch, Magnetic bit holder



Master Carton: 16

34PC DRILL AND SCREWDRIVER BIT SET

D-36980

HSS-R drill bits: 2, 2.5, 3, 3.5, 4, 4.5, 5mm
Masonry drill bits: 4, 5, 6, 7, 8mm
Wood drill bits: 4, 5, 6, 7, 8mm
25mm Screwdriver bits: T20, T25, T30, SL1, SL1.2, SL1.5, PH1, PH2, PH3, PZ1, PZ2, PZ3
Nutsetter: 7, 8, 10mm
 Countersink
 Magnetic Bit Holder



22 PIECE DRILL AND SCREWDRIVER BIT SET

P-44002

25mm Screwdriver Bits: PZ1, PZ2, PZ3, PH1, PH2, PH3 + 3 Slotted
HSS Drill Bits: 3, 4, 5, 6, 8mm
Masonry Drill Bits: 4, 5, 6, 8mm
Brad Point Drill Bits: 3, 4, 5mm
 Magnetic Bit Holder



Master Carton: 12

75PC DRILL BIT AND HOLESAW SET

P-90641

HSS Drill Bits: 3, 4, 5, 6, 7, 8mm
Flat Bits: 12, 16, 22mm
Masonry Drill Bits: 4, 5, 6, 8, 10mm
Brad Point Drill Bits
Holesaws: 32, 38, 44, 54mm
Screwdriver Bits: 25mm x 34
Nut Drivers: 5, 5.5, 6, 7, 8, 9, 10, 11mm
Depth Gauges: 3, 5, 6, 8
 Arbor Adaptor
 Countersink Bits x2
 Magnetic Bit Extension 60mm
 Hex Key 2.5mm
 Centre Punch



• Master carton quantities are for dealer use, all list prices are for individual sets (1-piece) except where stated by description.

DRILLING AND FIXING: BIT SETS

7PC MASONRY DRILL BIT POUCH

P-90015



1/4" hex shank Masonry drill bits:
5, 5.5, 6, 2 x 7, 8, 10mm

Master Carton: 12

14PC HSS DRILL BIT POUCH

P-90059



14x 1/4" Hex shank Titanium coated HSS drill bits.
2, 2.5, 3, 3.5, 4, 4.5, 5, 5.5, 6, 6.5, 7, 7.5, 8, 8.5mm

Master Carton: 12

17PC NUTRUNNER AND BIT POUCH

P-90043

Nutrunners: 6, 7, 8, 9, 10, 11, 13mm
Screw bits: PH1, PH2, PH3, 3 x Slotted: 4.5, 5.5, 6mm
1x Quick change chuck
1x Flex Quick change chuck
1 x Speed handle



Master Carton: 12

37PC DRILL AND BIT POUCH

P-90009

6x 50mm Screwdriver bits
14x 25mm Screwdriver bits
7x HSS bits 2-8mm
7x Masonry bits 4-10mm
1x Quick change chuck
1 x 60mm
Extension bar / 1 x Handle



Master Carton: 6

30PC IMPACT DRIVER BIT SET

P-57283

75mm bits:
PZ0, PZ1, PZ2, PH1, PH2, SL3, SL5
50mm bits:
PZ1, PZ2, PH1, PH2, SL3, SL5
25mm bits:
PZ0, PZ1, PZ2, PZ3, PH0, PH1, PH2,
PH3, SL3, SL4, SL5, SL6
Hex (3, 4, 5, 6mm).

1 x 60mm magnetic bit holder.



Master Carton: 24



29PC DRILL AND DRIVER SET

P-67701

25mm 1/4" Hex screwdriver bits:
PH1, PH2; PZ1, PZ2, PZ3; 3, 5, 6
Slot: 3, 4, 5, 6mm
Hex: 10, 15, 20, 25

60mm Magnetic bit holder 1/4" Hex
HSS Ground drill bits: 3, 4, 5, 6, 8mm

Masonry drill bits: 4, 5, 6, 8mm

3 Point wood drill bits: 4, 5, 6.5mm



• Master carton quantities are for dealer use, all list prices are for individual sets (1-piece) except where stated by description.

DRILLING AND FIXING: BIT SETS

19PC HSS-TIN METAL BIT SET D-67527



19 piece HSS-TIN metal drill bit set
 Sizes: 1.5-10mm

16PC TITANIUM PLATED HSS P-51873



16pc high precision ground HSS plated HSS bits.
 Sizes 1.5mm-10mm

Master Carton: 12

13PC MASONRY BIT SET P-51889



13pcs set of TCT drill bits for use in percussion drills in brick, block, and stone. Sizes 1 x 4mm, 1 x 5mm, 3 x 5mm, 3 x 5.5mm, 2 x 6mm, 2 x 7mm, 2 x 8mm

Master Carton: 12

28PC LONG LIFE SCREWDRIVER BIT SET P-51976



Selection of 50mm titanium coated screwdriver bits. Includes slotted, philips, pozi and hex and star drive. Length: 50mm

Master Carton: 12

5PC AUGER SET P-67686



20mm short length stubby auger bit set for wood working especially suited to working with angle screwdrivers or in tight spaces 16, 19, 22, 25, 32mm

Master Carton: 12

28PC PROFESSIONAL 4 WAY DRIVER SET P-70552



4-way drivers - pilot drill, countersink, counter bore and screwdriver with tool. Includes a range of popular 25mm screwdriver bits. Sizes 6, 8, 10, 12mm

Master Carton: 12

21PC DRILL AND DRIVER SET P-57087

6-HSS Drill, Titanium coated:
 2, 2.5, 3, 4, 5, 6mm.

8-25mm(L) Screwdriver Bits:
 PH1, PH2, PH3, PZ1, PZ2, PZ3,
 SL3, SL5

6-Masonry Drills:
 5.5, 6, 6.5, 7 (x2), 8mm

1x Mini Chuck



Master Carton: 24

15PC DRILL AND DRIVER SET P-57093

Hex Shank HSS Drill, Titanium Coated:
 2, 2.5, 3, 4, 5, 6mm.

Hex Shank Masonry Drill:
 5.5, 6, 6.5, 7(x2), 8mm.

50mm(L) Screwdriver Bits:
 PZ2, PZ3

1 x Maklok Quick Change Chuck.



Master Carton: 24

• Master carton quantities are for dealer use, all list prices are for individual sets (1-piece) except where stated by description.

DRILLING AND FIXING: DRILL BIT SETS

MAKPAC 17PC SDS-PLUS SET

B-52059

SDS+ Plus Drill Bits: 5.0mm x 110mm, 5.5mm x 110mm, 6.0mm x 110mm, 6.0mm x 160mm, 7.0mm x 160mm, 8.0mm x 110mm, 8.0mm x 160mm, 8.0mm x 210mm, 10.0mm x 110mm, 10.0mm x 160mm, 10.0mm x 210mm, 14.0mm x 260mm



SDS+ Plus Cold Chisels: 20.0mm x 140mm, 20.0mm x 250mm

SDS+ Plus Scaling Chisel: 40.0mm x 250mm

SDS+ Plus Bull Point Chisels: 140mm, 260mm

MAKPAC Inlay Trays x2

MAKPAC Connector Case Type 1

Master Carton: 3



18PC DRILL BIT ASSORTMENT SET

B-49432

HSS-G Drill Bits:

4,5,6,7,8,10

Brad Point Wood Drill Bits:

4,5,6,7,8,10

Masonry Drill Bits:

4,5,6,7,8,10



18PC MIXED DRILL BIT SET

P-23818

HSS Drill Bits:

3, 4, 5, 6, 8, 10mm

Masonry Drill Bits:

3, 4, 5, 6, 10mm

3 Point Wood Drill Bits:

3, 4, 5, 6, 8, 10mm



18PC MIXED DRILL BIT SET

D-47173

HSS Metal: 4, 5, 6, 7, 8, 10mm

Wood: 4, 5, 6, 7, 8, 10mm

Masonry: 4, 5, 6, 7, 8, 10mm



Master Carton: 20

HSS-R 13PC DRILL BIT SET

D-54075

HSS Metal: 1.5, 2, 2.5, 3, 3.2,

3.5, 4, 4.5, 5, 5.5, 6, 6.5mm

Straight (Cylindrical)



Master Carton: 20

HSS-R 19PC DRILL BIT SET

D-54081

HSS Metal: 1, 1.5, 2, 2.5, 3,

3.5, 4, 4.5, 5, 5.5, 6, 6.5, 7, 7.5,

8, 8.5, 9, 9.5, 10mm

Straight (Cylindrical)



Master Carton: 10

HSS-R 25PC DRILL BIT SET

D-54097

HSS Metal: 1, 1.5, 2, 2.5, 3,

3.5, 4, 4.5, 5, 5.5, 6, 6.5, 7,

7.5, 8, 8.5, 9, 9.5, 10, 10.5, 11,

11.5, 12, 12.5, 13mm. Straight

(Cylindrical)



Master Carton: 14

• Master carton quantities are for dealer use, all list prices are for individual sets (1-piece) except where stated by description.

39PC SCREWDRIVER BIT SET

P-79158

1 x Socket Drive: 1/4"
 1 x Magnetic Bit Holder: 1/4"
 1 x Reversible Ratchet Drive: 1/4"
 Length: 25mm
 Colour coded bits



- | | |
|-------------------|------------------------------------|
| 3.5, 5.5, 8mm | 6, 8, 10, 15, 20, 25, 27, 30, 40mm |
| 0, 1, (2x) 2, 3mm | 1, 2, 3mm |
| 1, (x4) 2, 3mm | 1.5, 2, 2.5, 3, 4, 5, 6, 7, 8mm |

Master Carton: 12



12PC SCREWDRIVER BIT SET

P-79142

1 x Socket 1/4" driver
 1 x 1/4" magnetic bit holder
 Length: 25mm
 Colour coded bits

- | | |
|------------|--------------|
| 3.5, 5.5mm | 2, 3mm |
| 2, 3mm | 3, 4, 5, 6mm |



Master Carton: 12



28PC SCREWDRIVER BIT SET

B-28911-6

25mm Bits: PZ0, PZ1, PZ2 x2, PZ3 / PH0, PH1, Ph2x3, PH3 / SL4, SL5, SL6 / Hex 2, Hex 2.5, Hex 3, Hex 4, Hex 5, Hex 6 / T10, T15, T20, T25, T27, T30, T40
 Magnetic Bit Holder 60mm



Master Carton: 6



18PC SCREWDRIVER BIT SET

B-28896-6

25mm Bits: PZ1, PZ2 (x2), PZ3 / PH1, PH2 (x2), PH3
50mm Bits: PZ1, PZ2, PZ3 / PH1, PH2, PH3 / SL4, SL5, SL6
 60mm Quick Change Bit Holder



Master Carton: 6



18PC SCREWDRIVER BIT SET

B-43000-12

25mm Bits: PH2 (x8)
50mm Bits: PH2 (x3), PZ1, PZ2, PZ3, SL4, SL5, SL6
 60mm Quick Change Bit Holder



Master Carton: 12



37PC SCREWDRIVER BIT SET 10 PACK

B-28606-10

- 1/4" Hex Shank
- Magnetic Holder



- PZ0, PZ1, PZ2, PZ2, PZ3
- PH0, PH1, PH2, PH2, PH3
- H3, H4, H5, H6

- SL0.5x4, SL0.6x4.5, SL1.0x5.5, SL1.2x6.5
- T10, T15, T15H, T20, T20H, T25, T25H, T27, T27H, T30, T30H, T40, T40H, T15H, T20H, T25H, T27H, T30H, T40H

Master Carton: 10



Single price for distribution from master carton only.

• Master carton quantities are for dealer use, all list prices are for individual sets (1-piece) except where stated by description.

Batteries & Cases
 Tool Holders
 Drilling
 Fixing
 Saw Blades
 Jigsaw & Recip
 Multi Tool
 Diamond
 Bonded Abrasives
 Flap Discs
 Coated Abrasives
 Router Cutters
 Dust Extraction
 Ground Maintenance

DRILLING AND FIXING: BIT SETS

47PC RATCHET SET 10 PACK

B-36170-10

- 1/4" Hex Shank
- Magnetic holder
- 2 way rotation



Price shown is for a pack of 10

- 2xPH1, 2xPH2, 2xPH3
- 2xPZ1, 2xPZ2, 2xPZ3
- 2xT10, 2xT15, 2xT20, 2xT25, 2xT30, 1xT40



- 1xH2, 1xH2.5, 1xH3, 2xH4, 2xH5, 2xH6
- 2xSL4.5, 2xSL5.5, 2xSL6.5
- Sockets: 5, 6, 7, 8, 9, 10, 11mm

Master Carton: 10

48PC HSS-G SCREW AND SOCKET SET 10 PACK

B-36192-10

- 1/4" Hex Shank
- Magnetic holder
- 2 way rotation



Price shown is for a pack of 10

- 2xPH1, 2xPH2, 1xPH3
- 2xPZ1, 2xPZ2, 1xPZ3
- 1xT10, 2xT15, 2xT20, 2xT25, 2xT30, 1xT40



- 1xSL4.5, 2xSL5.5, 2xSL6.5
- 1xH2, 1xH2.5, 1xH3, 1xH4, 2xH5, 2xH6
- Sockets 1.5, 2, 2.5, 3, 3.5, 4, 4.5, 5, 6mm

Master Carton: 10

21PC SCREW BIT SET IN BATTERY SHAPE CASE

B-68323



Fits into a Makita case's spare battery slot.
50mm Screw bits: PH1, PH2, PH3, PZ1, PZ2 x2, PZ3, T10, T15, T20, T25 x2, T30 x2, Hex3, Hex4, Hex5, Hex6, SL0.8 x2, SL5.5, SL6.5

BATTERY SHAPED PLASTIC CASE

B-69917



Battery shaped plastic case.
Fits into a Makita case's spare battery slot.

25PC SCREWDRIVER BIT SET WITH MAG HOLDER

P-49965



Quick release
Bit holder
Length: 25mm
Master Carton: 24

- | | |
|-----------------|------------------------|
| 1, 2, 3mm | 10, 15, 20, 25, 30, 40 |
| 1, 2, 3mm | 1, 2, 3mm |
| 4.5, 5.5, 6.5mm | 1.5, 2, 3, 4, 5, 6mm |

• Master carton quantities are for dealer use, all list prices are for individual sets (1-piece) except where stated by description.

DRILLING AND FIXING: BIT SETS

13 IN 1 RATCHET SCREWDRIVER SET

P-90071-12

Price shown is for a pack of 12



6x 25mm: PZ2 / Slotted 3mm / Star 10, 20mm, Hex 4mm, 5mm
 6x 50mm: Slotted 3, 4, 5mm / PZ1, PZ2, PZ3
 1x Magnetic quick change hex chuck
 1x Speed handle

Master Carton: 12



11PC 25mm SCREWDRIVER BIT SET

P-49046



Length: 25mm
 Tin Coated

- 1, 2.2, 3mm
- 1, 2.2, 3mm
- 3.5, 5.5mm

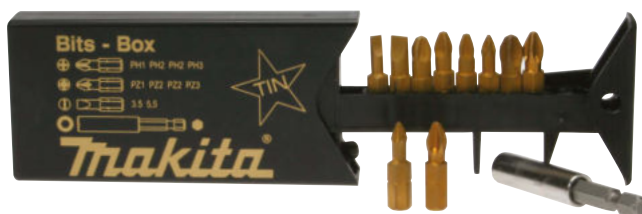

11PC 25mm SCREWDRIVER BIT SET

P-38526



Length: 25mm

- 1, 2, 3mm
- 1, 2, 3mm
- 4.5, 5.5, 6.5, 8mm



11PC SCREWDRIVER SETS

D-30651-12



Magnetic bit holder.
 Supplied in pack of 12 only

Master Carton: 12

- 1, 2, 3mm
- 1, 2, 3mm
- 15, 20, 25, 30



7PC SCREWDRIVER ANTI-SLIP BIT SET

P-17980



ACR bits
 Mag bit holder
 ACR (anti cam out)
 Length: 25mm

- 1, 2, 3mm
- 1, 2, 3mm



• Master carton quantities are for dealer use, all list prices are for individual sets (1-piece) except where stated by description.

DRILLING AND FIXING: BIT SETS

20PC GOLDCREST TUB PZ2 25mm P-45294



25mm

PZ2 Titanium
Length: 20mm

Master Carton: 20

100PC TUB PZ2 25mm P-49971



25mm

Bulk, high quality screwdriver bits.
Length: 25mm

Master Carton: 12

50PC TUB PZ2 50mm P-65779



50mm

Bulk, high quality screwdriver bits.
Length: 50mm

Master Carton: 12

50PC TUB PZ3 50mm P-65785



50mm

Bulk, high quality screwdriver bits.
Length: 50mm

Master Carton: 12

50PC CANDY JAR MAGNETIC NUTSETTER 8mm B-67773







Bulk, high quality nutsetter bits.
Length: 50mm
Size: 8mm M5

30PC CANDY JAR MAGNETIC NUTSETTER 10mm B-67789



Bulk, high quality nutsetter bits.
Length: 50mm
Size: 10mm M6

25PC TORSION SCREWDRIVER BITS IN A "TIC TAC" BOX

25mm

High quality screwdriver bits with tough yet flexible torsion zone, cushions peak torque during hard applications and helps extend bit life considerably. Can be purchased in countertop display box (x16 Tic Tac boxes)

+	P-74887	PH2 x 25mm
*	P-74893	PZ2 x 25mm
*	P-74902	T15 x 25mm
*	P-74918	T20 x 25mm
*	P-74924	T25 x 25mm

• Master carton quantities are for dealer use, all list prices are for individual sets (1-piece) except where stated by description.

Saw Blades

TCT Saw Blades. Every blade for any job

The Makita Tungsten Carbide Tipped (TCT) saw blades range is a comprehensive and professional selection for all makes of saw. Manufactured for industrial and trade use to the most exacting standards from the finest Japanese cutting steel, they are of the highest quality and produce the finest cuts with reliable performance. Each tooth is perfectly honed to a mirror-like finish which results in micro-chipping and ensures a sharper, keener edge.

FOR PORTABLE SAWS



A series of blades designed for efficient cutting in a variety of materials. Up to 2.5 times faster cuts and up to 2.4 times more cuts than a standard saw blade.



Specialized blades are precision manufactured for specific applications, machines and materials. The blades embedded teeth powerfully cut through knots and wood with nails.



Blades with a revolutionary and advanced tooth design featuring twin teeth to cut faster and cleaner.



A comprehensive range of quality manufactured portable saw blades that are produced for a broad range of applications.

FOR STATIONARY SAWS



The perfect compliment to Makita's superb slide compound mitre and table saws, these blades represent the pinnacle of engineering excellence.



A range of blades for mains and battery powered mitre saws covering all the popular makes and models.

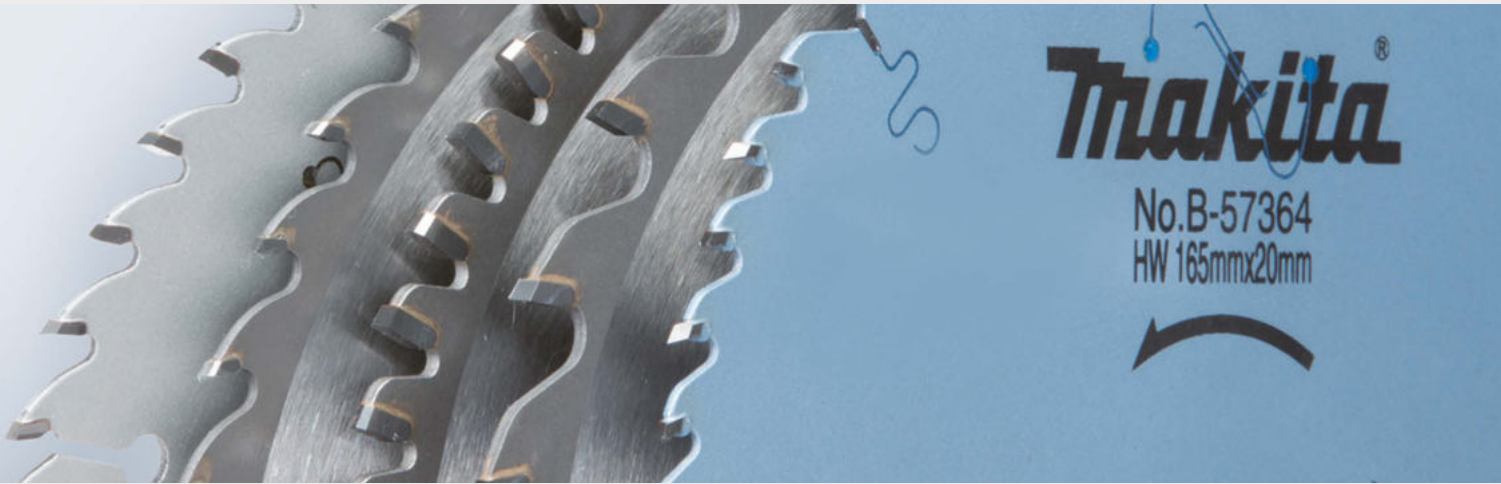

How to read the Makita saw blade identification code.



Type of Cut

C = Course
M = Medium
F = Fine
XF = Extra Fine
S = Stainless Steel

Blade Diameter Ø mm

Bore Diameter Ø mm

A = 10mm
B = 15mm
C = 15.88mm
D = 16mm
E = 20mm
F = 25.4mm
G = 30mm

CSCX23024GL

Saw Blade Type

MS = Mitre Saw
CS = Circular Saw (Mains)
TS = Table Saw
CMS = Cordless Mitre Saw
CC = Cordless Circular Saw
BSS = BSS610 Li-ion
CSP = Circular Saw Plunge
MC = Metal Cutting

Blade Special Type

X = M Force
E = Tip Embedded Tooth
A = Aluminium

Number of Teeth

Special Features

L = Laser Slit Quiet Running

EXAMPLES

MSXF305100GL: Mitre Saw Blade - Extra Fine Cut - 305mm Dia - 100 Teeth - 30mm Bore - Laser Slit Quiet Running
CCM15024A: Cordless Circular Saw - Medium Cut - 150mm Dia - 24 Teeth - 10mm Bore
TSA20064G: Table Saw - Aluminium Cutting - 200mm Dia - 64 Teeth - 30mm Bore

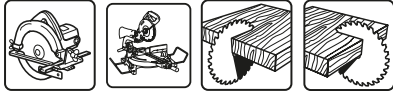
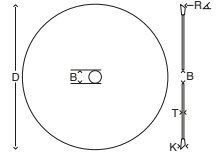

D mm	Part No.	ID Code	K mm	B mm	Tooth Count	T mm	Rake (R)	Ring mm	Cross Cut	Rip Cut	Max RPM	Machine	Material
165	B-57320	CCXF16556EL	1.45	20	56	1	23°				9,250	Plunge saw	Wood, lam
165	B-62979	CCM16525E	1.45	20	25	1	23°				9,250	Cordless	Wood, lam
165	B-69858		1.85	20	60	1.85	10°				9,250	Cordless	Wood, lam
190	B-64185	CCM19024G	1.45	30	24	1	23°				8,040	Cordless Circ saw	Wood, lam
190	B-68622		1.45	30	45	1	23°				8,250	Cordless	Wood
260	B-64624	CMSM26045G	2.15	30	45	1.65	10°				5,870	Cordless Mitre saw	Wood, lam
235	E-01909		2.2	30	24	2.2	20°				6,500	Cordless	Wood
260	B-67234	CMSF26060G	2.15	30	60	1.65	10°				5,870	Cordless	Wood
260	B-67240	CMSXF26080G	2.15	30	80	1.65	10°				5,870	Cordless	Wood
305	B-67256	CMSM30560G	2.15	30	60	1.65	10°				5,000	Cordless	Wood
305	B-67262	CMSF30580G	2.15	30	80	1.65	10°				5,000	Cordless	Wood
305	B-67278	CMSXF305100G	2.15	30	100	1.65	10°				5,000	Cordless	Wood





EFFICIENT
Sharp top angle



Fine cutting with little effort.



EFFICIENT
Curved body

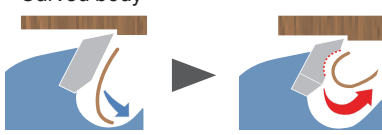

Excellent chip removal.



EFFICIENT
Slimmed bottom

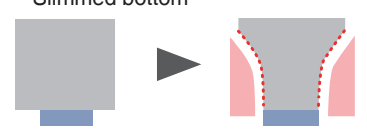

Less resistance longer battery life.

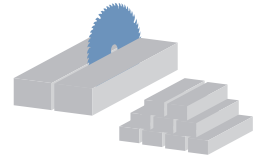

More Cuts Per Charge



Fast Cutting



Long Life

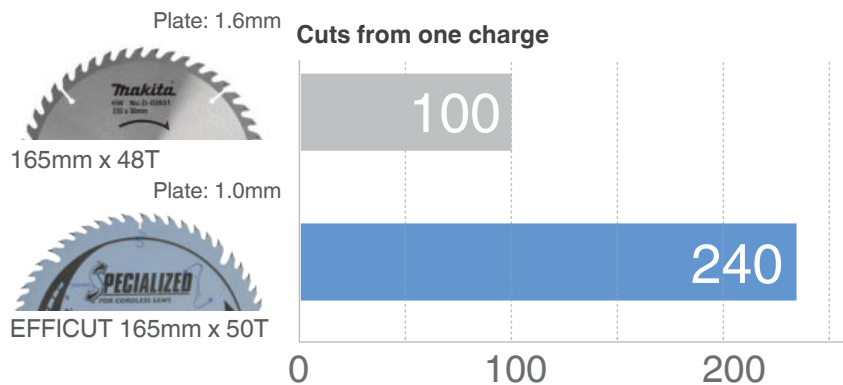

2.4x
More Cuts

1. The test results depend to a great extent on the hardness of wood materials, etc.
 2. The cutting amount bar graphs are relative values when the capacity of current blade (Thickness : 1.6 mm) is indexed at 100.

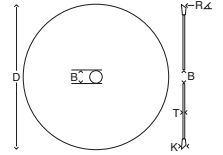

D mm	Part No.	ID Code	K mm	B mm	Tooth Count	T mm	Flake (R)	Ring mm	Cross Cut	Rip Cut	Max RPM	Machine	Material
136	B-69266		1.1	20	30	0.95	0°				4,500	Cordless	Metal
150	B-69288		1.1	20	33	0.95	0°				4,680	Cordless	Metal
136	B-69272		1.1	20	45	0.95	0°				4,500	Cordless	Stainless
150	B-69294		1.1	20	48	0.95	0°				4,680	Cordless	Stainless



EFFICIENT
Resistant to chipping

EFFICIENT
Removes swarf smoothly

EFFICIENT
Superior straight cutting

More Cuts Per Charge

Fast Cutting

Long Life

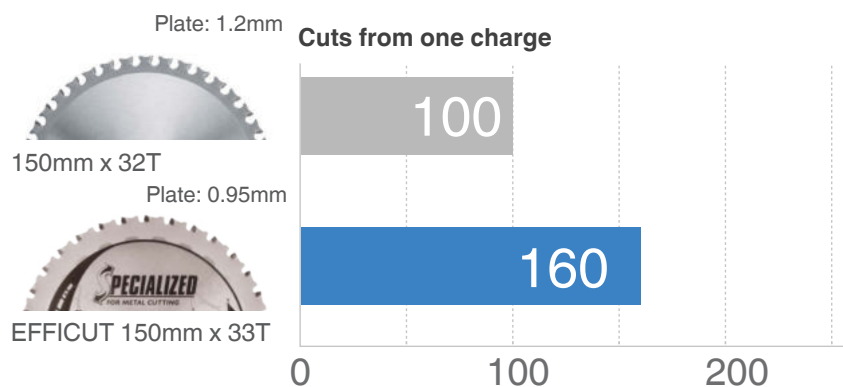

**1.6x
More Cuts**

Model: DCS553 (BL1860B)
Material: Carbon steel pipe (Dia: 31mm / Thickness: 3mm)

SAW BLADES

SPECIALIZED METAL CUTTING



Makita's range of metal cutting saw blades are designed to cut faster, cleaner and quicker.

Specially formulated carbide, combined with a unique tip design resists breakage on impact and lasts longer when cutting mild steel, sheet, pipe, channel, and threaded rod. Cutting quicker and cleaner Makita metal cutting blades will out last traditional abrasive discs up to 30 times.

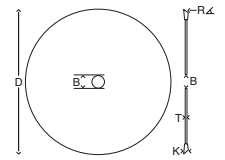

* Corrugated plate
** Thin mild steel

- Specially formulated carbide tips precision ground for fast, clean cutting.
- Low sparking and minimal dust production.
- Cool cuts with burr free edges.
- Reduced cost per cut.

D mm	Part No.	ID Code	K mm	B mm	Tooth Count	T mm	Rake (R)	Ring mm	Cross Cut	Pack	Max RPM	Machine	Material
185	B-09743	MCS18536G	1.9	30	36	1.5	0°			1	5,800	Portable saw	Mild steel
185	B-09759	MCS18538G	2	30	38	1.6	0°			1	5,800	Portable saw	Mild steel
185	B-09787	MCS18548G	2	30	48	1.6	0°			1	5,800	Portable saw	Mild steel
185	B-09771	MCS18570G	1.7	30	70	1.3	-10°			1	5,800	Portable saw	Plate
305	B-09765	MCS30560F	2.1	25.4	60	1.7	0°			1	2,000	Cut-off saw	Mild steel
305	B-09793	MCS30578F	2.3	25.4	78	2	-5°			1	2,000	Cut-off saw	Mild steel

SPECIALIZED STAINLESS CUTTING



Makita's range of stainless steel cutting saw blades are designed to cut faster, cleaner and quicker.

Specially formulated carbide, combined with a unique tip design resists breakage on impact and lasts longer when cutting stainless steel. Cutting quicker and cleaner, Makita metal cutting blades will out last traditional abrasive discs up to 30 times.

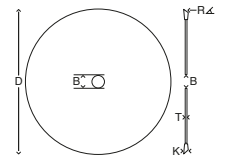

- Specially formulated carbide tips precision ground for fast clean cutting.
- Low sparking and minimal dust production.
- Cool cuts with burr free edges.
- Reduced cost per cut.

D mm	Part No.	ID Code	K mm	B mm	Tooth Count	T mm	Rake (R)	Ring mm	Cross Cut	Pack	Max RPM	Machine	Material
136	B-23086	MCS13656E	1.5	20	56	1.5	-5°			1	3,600	BCS550	Stainless
150	B-47173	MCCS15060E	1.1	20	60		0°			1	4,680		Stainless
185	B-07870	MCSS18540G	1.8	30	40	1.8	-3°			1	5,160	4131	Stainless
185	B-31669	MCSF18564GL	1.6	30	64	1.3	0°			1	5,800	Portable	Stainless
305	B-23123	MCS305100F	2.4	25.4	100	1.5	-5°			1	2,000	Cut-off saw	Stainless
PACKS													
136	B-34752	MCS13656E	1.5	20	56	1.5	-5°			3	3600	Cordless saw	Stainless
185	B-34774	MCSF18564GL	1.6	30	64	1.3	0°			3	5,800	Portable saw	Stainless
305	B-34796	MCS305100F	2.4	25.4	100	1.5	-5°			5	2,000	Cut-off saw	Stainless
136	B-23086-10	MCS13656E	1.5	20	56	1.5	-5°			10	3,600	BCS550	Stainless

SAW BLADES

SPECIALIZED CONSTRUCTION



Construction blades are designed to be hard working on site, strong enough to cut through construction timber, formwork and chipboards. When speed is more important than making sure your timber is free from nails and concrete residue the construction blades are key.

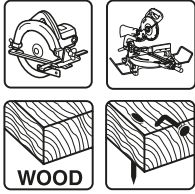
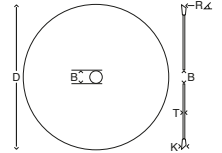

WOOD

D mm	Part No.	ID Code	K mm	B mm	Tooth Count	T mm	Rake (R)	Ring mm	Cross Cut	Rip Cut	Max RPM	Machine	Material
190	B-13683	CSCE19012G	2.6mm	30	12	1.6mm	20°				8,040	Portable saw	*
235	B-13699	CSCE23516G	3.0mm	30	16	2.6mm	20°				6,050	Portable saw	*

* Shutter boards, chipboard, construction timber with nails, concrete residues and construction timber.

SPECIALIZED ALUMINIUM CUTTING



A range of blades for portable, Mitre and table saws with excellent cutting performance in aluminium, copper, brass, bronze and other non-ferrous metals. The blades are also suitable for working on plastics and laminated wood.

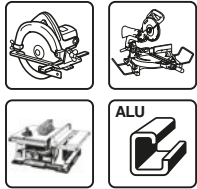
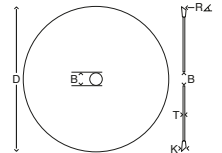

ALU

- Precision plate tensioning for a flatter blade and truer cuts.
- Excellent cut quality in non-ferrous materials.

Apply blade wax to tip area frequently to prevent chip build up in blade gullets when cutting non-ferrous metals.

D mm	Part No.	ID Code	K mm	B mm	Tooth Count	T mm	Rake (R)	Ring mm	Cross Cut	Rip Cut	Max RPM	Machine	Material
136	B-40294	CSA13650E	1.6	20	50	1	0°				4,500	DCS550	Aluminium
150	B-47189	MCCSA15052E	1.6	20	52		0°				4,680	Cordless	Aluminium
160	B-09553	CSA16060E	2.4	20	60	1.8	0°				9,540	Portable saw	Aluminium
160	B-09569	CSA16060G	2.4	30	60	1.8	0°	20			9,540	Portable saw	Aluminium
165	B-56552	CMSA16560EL	1.8	20	60	1.2	5°				9,250	Mitre saw	Aluminium
180	B-09575	CSA18060G	2.4	30	60	1.8	0°	15.88/20			8,480	Portable saw	Aluminium
185	B-09581	CSA18560C	2.4	15.88	60	1.8	0°				8,250	Portable saw	Aluminium
190	B-09597	CSA19060G	2.4	30	60	1.8	0°	15.88/20			8,040	Portable saw	Aluminium
190	B-09612	MSA19060E	2	20	60	1.4	-5°				8,040	Mitre saw	Aluminium
200	B-09690	TSA20064G	2.8	30	64	2.2	0°				7,630	Table saw	Aluminium
216	B-09628	MSA21664G	2.2	30	64	1.6	-5°				7,070	Mitre saw	Aluminium
235	B-09606	CSA23580G	2.4	30	80	1.8	0°				6,500	Portable saw	Aluminium
250	B-09634	MSA25080G	2.4	30	80	1.8	-5°				6,110	Mitre saw	Aluminium
250	B-09709	TSA25080G	2.8	30	80	2.2	0°				6,110	Table saw	Aluminium
250	B-09640	MSA250100G	2.4	30	100	1.8	-5°				6,110	Mitre saw	Aluminium
260	B-09656	MSA26080G	2.3	30	80	1.8	-5°				5,870	Mitre saw	Aluminium
260	B-09715	TSA26080G	2.8	30	80	2.2	0°				5,870	Table saw	Aluminium
260	B-09662	MSA260100G	2.3	30	100	1.8	-5°				5,870	Mitre saw	Aluminium
300	B-09721	TSA30080G	2.8	30	80	2.2	0°				5,090	Table saw	Aluminium
305	B-09678	MSA30580G	2.3	30	80	1.8	-5°				5,000	Mitre saw	Aluminium
305	B-09684	MSA305100G	2.3	30	100	1.8	-5°				5,000	Mitre saw	Aluminium
350	B-09737	TSA350100G	3.2	30	100	2.6	0°				4,360	Table saw	Aluminium

Batteries & Cases
Tool Holders
Drilling
Fixing
Saw Blades
Jigsaw & Recip
Multi Tool
Diamond
Bonded Abrasives
Flap Discs
Coated Abrasives
Router Cutters
Dust Extraction
Ground Maintenance

SAW BLADES

SPECIALIZED CORDLESS SAWS



Premium saw blades made especially for cordless saws.

Blades for wood cutting, with the most popular cordless circular saw models are now available. All with Makita quality!

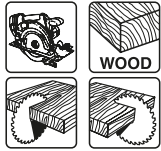

- Ultra-thin, perfectly tensioned steel plates for true run.
- Extends battery life.
- Precision honed, high-grade carbide for easy, smooth cuts and long life.
- Tooth configurations to meet specific cutting, material and thickness applications.

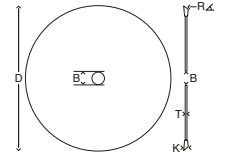

D mm	Part No.	ID Code	K mm	B mm	Tooth Count	T mm	Rake (R)	Ring mm	Cross Cut	Rip Cut	Max RPM	Machine	Material
85	B-09204	CCM8520B	1	15	20	0.7	10°		•	•	2,240	Cordless saw	Wood
85	B-16885	CCF8520B	1	15	20	0.7	10°		•	•	2,240	Cordless saw	Wood
136	B-09139	CCM13624A	1.5	10	24	1	20°		•	•	4,500	Cordless saw	Wood
136	B-09210	CCF13636A	1.5	10	36	1	18°		•	•	4,500	Cordless saw	Wood
136	B-10643	CCC13616E	1.5	20	16	1	20°		•	•	4,500	Cordless saw	Wood
136	B-10615	MCCS13630E	1.5	20	30	1.2	0°		•	•	4,500	BCS550	Mild steel
150	B-09145	CCM15024A	1.5	10	24	1	20°		•	•	2,500	Cordless saw	Wood
150	B-09226	CCF15040A	1.5	10	40	1	18°		•	•	2,500	Cordless saw	Wood
150	B-47151	MCCS15032E	1.5	20	32	1.2	0°		•	•	4,680	Cordless saw	Metal
150	B-46296	1.5	20	32	1.2	0°		•	•	•	4,680	DCS551	Metal
150	B-47167	MCCS15052E	1.4	20	52	1.1	-15°		•	•	4,680	DCS551	Sheet metal
150	B-47173	MCCS15060E	1.1	20	60	0.95	0°		•	•	4,680	DCS551	Metal
150	B-47020	1.6	20	52	1	0°		•	•	•	4,680	DCS551	Alu
160	B-09151	CCC16024E	1.5	20	24	1	20°		•	•	4,770	Cordless saw	Wood
165	B-09167	CCC16524E	1.5	20	24	1	20°		•	•	4,770	Cordless saw	Wood
165	B-09173	BSS16524E	1.5	20	24	1	20°		•	•	4,770	Cordless saw	Wood
165	B-09189	CCC16524A	1.5	10	24	1	20°		•	•	4,770	Cordless saw	Wood
165	B-09232	CCM16540E	1.6	20	40	1	18°		•	•	4,770	Cordless saw	Wood
165	B-09248	BSS16540E	1.6	20	40	1	18°		•	•	4,770	Cordless saw	Wood
165	B-53207	CCM16544E	1.45	20	44	1	23°		•	•	6,500	Cordless saw	Wood
165	B-09248	1.6	20	40	1	18°		•	•	•	4,770	Cordless saw	Wood
180	B-21967	CMSC19024E	1.9	20	24	1.4	-18°		•	•	3,000	BLS713	Wood
190	B-09195	CCC19024G	2	30	24	1.4	20°		•	•	3,000	Cordless saw	Wood
190	B-09254	CCM19040G	2	30	40	1.4	10°		•	•	3,000	Cordless saw	Wood
190	B-20694	CMS19040E	1.9	20	40	1.4	10°		•	•	3,000	BLS713	Wood
190	A-86147	1.9	20	40	1.4	10°		•	•	•	3,000	BLS713	Wood
190	B-53291	CMSF1906EL	1.7	20	60	1.3	20°		•	•	8,040	Cordless saw	Wood/MDF Laminate

SPECIALIZED PLUNGE CUT



Blades Designed specifically for Plunge Type Saws.

Available for cutting both wood and aluminium, they are especially designed for a smooth clean cut. Plunge saw blades carry a similar specification to the Premium MakBlade Plus, with a patented technology dampening vibration. The low vibration blades run truer with less wobble easily plunging into material with little effort.

- Vibration dampening system featuring resin bond filled laser cuts and body slots.
- Precision plate tensioning for a flatter blade and truer cuts.
- Available for wood and aluminium cutting.

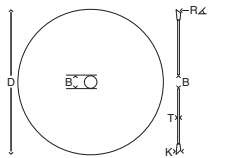

D mm	Part No.	ID Code	K mm	B mm	Tooth Count	T mm	Rake (R)	Ring mm	Cross Cut	Rip Cut	Max RPM	Machine	Material
160	B-09260	CSP1608E	2.2	20	28	1.6	23°		•	•	9,540	Plunge saw	Wood
160	B-09276	CSPM16048E	2.2	20	48	1.6	8°		•	•	9,540	Plunge saw	Wood
165	B-09282	CSPC16528E	2.2	20	28	1.6	23°		•	•	9,250	Plunge saw	Wood
165	B-09298	CSPM16548E	2.2	20	48	1.6	8°		•	•	9,250	Plunge saw	Wood
165	B-09307	CSPXF16556E	2.4	20	56	1.7	-3°		•	•	9,250	Plunge saw	Aluminium
165	B-10344	CSPXF16548E	2.4	20	48	1.7	5°		•	•	9,250	Plunge saw	Corrian
185	B-09313	CSP18524C	2.2	15.88	24	1.6	20°		•	•	8,250	Plunge saw	Wood
190	B-19015	CSP19024G	2.2	30	24	1.6	20°		•	•	8,040	Plunge saw	Wood
165	B-56699	2	20	28	1.4	15°		•	•	•	9,250	DSP600	Wood
165	B-56708	1.85	20	48	1.25	8°		•	•	•	9,250	DSP600	Wood
165	B-56714	2	20	56	1.4	-3°		•	•	•	9,250	DSP600	Aluminium
165	B-56720	2	20	60	1.4	5°		•	•	•	9,250	DSP600	MDF, Lam
165	B-56736	2	20	60	1.4	5°		•	•	•	9,250	DSP600	MDF, Lam
165	B-56742	2	20	48	1.4	5°		•	•	•	9,250	DSP600	Corrian

SAW BLADES

SPECIALIZED LAMINATE CUTTING



A range of TCT sawblades designed for performance cutting in Laminate board. Available in a wide range of sizes for portable, mitre and table saws.

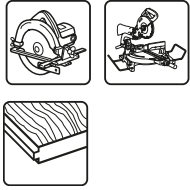

The ultra-non-friction coating assures protection from heat, rust and corrosion. Resin-filled slots to decrease sound levels and a unique triple chip grind tooth configuration to eliminate risk of chipping. Each feature plays a vital part in the effectiveness and performance of this blade.

- Ultra non-friction protective coating
- Specialist tooth configuration for non-chipping
- Sound and vibration control
- Extremely long life, effortless cutting and outstanding results.

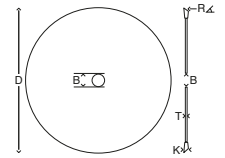

D mm	Part No.	ID Code	K mm	B mm	Tooth Count	T mm	Rake (R)	Ring mm	Cross Cut	Rip Cut	Max RPM	Machine	Material
85	B-29430	CCXF8524B	1	15	24	0.7	7°				2240	Portable	Laminate
136	B-29446	CCXF13648E	1.4	20	48	1	10°				4500	BCS550	Laminate
165	B-29452	CCXF16552EL	1.45	20	52	1	5°				4770	Portable	Laminate
190	B-29468	MSXF19060GL	2	20	60	1.4	5°				8040	Mitre	Laminate
216	B-29474	MSXF21672GL	2.5	30	72	1.8	5°				7070	Mitre	Laminate
250	B-29480	MSXF25084GL	2.5	30	84	1.8	5°				6110	Stationary	Laminate
260	B-29496	MSXF26084GL	2.5	30	84	1.8	5°				5870	Mitre	Laminate
305	B-29505	MSXF30596GL	2.5	30	96	1.8	5°				5000	Stationary	Laminate

SPECIALIZED SANDWICH PANEL



A range of blades especially for cutting metal composite materials, more commonly known as sandwich panel - two thin skins of metal bonded to an insulated core. Designed to cut the metal skins leaving a clean non-burr finish with little heat generation to help preserve the bond between the two materials and thus preventing deterioration.

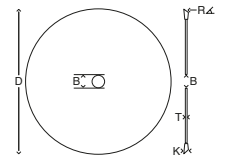

D mm	Part No.	ID Code	K mm	B mm	Tooth Count	T mm	Rake (R)	Ring mm	Cross Cut	Rip Cut	Max RPM	Machine	Material
165	B-63133	CSF16545EL	1.75	20	45	1.4	0°				9,250	Circular saw	*
235	B-17675	CSF23550GL	2.4	30	50	1.8	0°				6,500	Mitre saw	*
270	B-17681	CSF27060GL	2.6	30	60	2.0	0°				5,650	Mitre saw	*
355	B-17697	CSF35580GL	3.20	30	80	2.6	0°				4,300	Mitre saw	*

* Sandwich Panel and Steel Plate Cladding

Batteries & Cases
Tool Holders
Drilling
Fixing
Saw Blades
Jigsaw & Recip
Multi Tool
Diamond
Bonded Abrasives
Flap Discs
Coated Abrasives
Router Cutters
Dust Extraction
Ground Maintenance

SPECIALIZED FIBRE CEMENT BOARD (PCD)

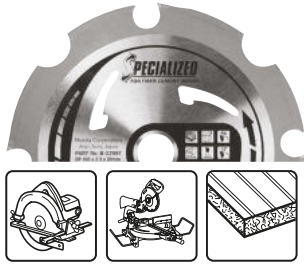

As one of the growing environmentally friendly materials in the construction industry, fibre cement board requires the ultimate cutting blade and Makita has created just that.

Makita's range of PCD circular saw blades have been designed to give an outstanding performance when cutting fibre cement board including "Hardy Board," "Marley Weatherboard" and compressed concrete.

- Polycrystalline Diamond Tipped teeth for durability and longer life.
- Smoother, cleaner, more accurate cutting.
- Unbeatable performance in multiple layer cutting.

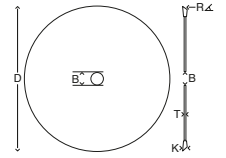

D mm	Part No.	ID Code	K mm	B mm	Tooth Count	T mm	Rake (R)	Ring mm	Cross Cut	Rip Cut	Max RPM	Machine	Material
165	B-22997	CSC1654EPCD	2.1	20	4	1.4	10°					Portable saw	F.C.B
190	B-23008	CSC1904GPCD	2.1	30	4	1.4	10°					Portable saw	F.C.B
260	B-23014	MSC2606GPCD	2.3	30	6	1.8	5°					Mitre saw	F.C.B
305	B-23020	MSC3058GPCD	2.5	30	8	1.8	5°					Mitre saw	F.C.B

SPECIALIZED TIP EMBEDDED



Designed to fit both Makita and other manufacturer's saws, tip embedded or "Deep Tooth" blades are especially tough and hard wearing.

Easily copes with knotty wood and will slice through nail and screw embedded timber without damaging teeth. Suitable for reclaimed timber and demolition work.

- Nail and Knot Cutting.
- Extremely tough and hard wearing.
- Extended service life and productivity.

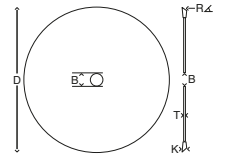

D mm	Part No.	ID Code	K mm	B mm	Tooth Count	T mm	Rake (R)	Ring mm	Cross Cut	Rip Cut	Max RPM	Machine	Material
165	B-09329	CSCE16516E	2	20	16	1.25	23°		•	•	9,250	Portable saw	Wood/Nails
165	B-09391	CSME16524E	2	20	24	1.25	23°		•	•	9,250	Portable saw	Wood/Nails
165	B-09472	CSME16540E	2	20	40	1.25	18°		•	•	9,250	Portable saw	Wood/Nails
185	B-09335	CSCE18516C	2	15.88	16	1.25	25°		•	•	8,250	Portable saw	Wood/Nails
185	B-09341	CSCE18516G	2	30	16	1.25	25°		•	•	8,250	Portable saw	Wood/Nails
185	B-09400	CSME18524C	2	15.88	24	1.25	23°		•	•	8,250	Portable saw	Wood/Nails
185	B-09416	CSME18520G	2	30	20	1.25	25°		•	•	8,250	Portable saw	Wood/Nails
185	B-09488	CSME18540C	2	15.88	40	1.25	25°		•	•	8,250	Portable saw	Wood/Nails
185	B-09494	CSME18540G	2	30	40	1.25	25°		•	•	8,250	Portable saw	Wood/Nails
190	B-09357	CSCE19016G	2	30	16	1.25	23°		•	•	8,040	Portable saw	Wood/Nails
190	B-09422	CSME19024G	2	30	24	1.25	23°		•	•	8,040	Portable saw	Wood/Nails
190	B-09503	CSME19040G	2	30	40	1.25	23°		•	•	8,040	Portable saw	Wood/Nails
190	B-40587	MSCE19024E	2.2	20	24	1.6	5°		•	•	8,040	Mitre saw	Wood/Nails
190	B-40593	MSME19040E	2	20	40	1.4	5°		•	•	8,040	Mitre saw	Wood/Nails
210	B-09363	CSCE21018G	1.9	30	18	1.4	23°		•	•	7,300	Portable saw	Wood/Nails
210	B-09438	CSME21024G	1.9	30	24	1.4	23°		•	•	7,300	Portable saw	Wood/Nails
216	B-40602	MSCE21624G	2.4	30	24	1.6	5°		•	•	7,070	Mitre saw	Wood/Nails
216	B-40618	MSME21640G	2	30	40	1.4	5°		•	•	7,070	Mitre saw	Wood/Nails
235	B-09379	CSCE23520G	2.3	30	20	1.6	25°		•	•	6,500	Portable saw	Wood/Nails
235	B-09444	CSME23524G	2.3	30	24	1.6	23°		•	•	6,500	Portable saw	Wood/Nails
235	B-09519	CSME23548G	2.3	30	48	1.6	18°		•	•	6,500	Portable saw	Wood/Nails
260	B-40624	MSCE26032G	2.3	30	32	1.8	5°		•	•	5,870	Mitre saw	Wood/Nails
260	B-40630	MSME26064G	2.3	30	64	1.8	5°		•	•	5,870	Mitre saw	Wood/Nails
270	B-09450	CSME27024G	2.6	30	24	1.8	23°		•	•	5,650	Portable saw	Wood/Nails
270	B-09525	CSME27040G	2.6	30	40	1.8	18°		•	•	5,650	Portable saw	Wood/Nails
270	B-09531	CSME27060G	2.6	30	60	1.8	18°		•	•	5,650	Portable saw	Wood/Nails
305	B-40646	MSCE30532G	2.3	30	32	1.8	5°		•	•	5,000	Mitre saw	Wood/Nails
305	B-40652	MSME30560G	2.3	30	60	1.8	5°		•	•	5,000	Mitre saw	Wood/Nails
355	B-09385	CSCE35524G	3	30	24	2.2	23°		•	•	4,300	Portable saw	Wood/Nails
355	B-09466	CSME35540G	3	30	40	2.2	23°		•	•	4,300	Portable saw	Wood/Nails
355	B-09547	CSME35560G	3	30	60	2.2	18°		•	•	4,300	Portable saw	Wood/Nails

SAW BLADES

MFORCE FOR PORTABLE SAWS



A revolutionary advanced tooth design that sets a new bench mark for blade technology.

The dual bevelled tooth face has sharper cutting edges and the "M" shape is like doubling the tooth count per blade. A greater wear area and more cutting surfaces means the MForce blade will last up to 2 x longer than traditional blades. A narrow kerf and plate reduces friction allowing for a lighter feed pressure, protecting the motor of your saw.

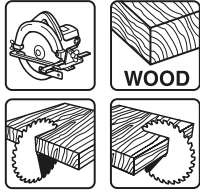
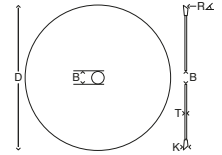

- Twice the finish with half the teeth.
- Aggressive cutting.
- Greater wear area.
- Longer lasting.

D mm	Part No.	ID Code	K mm	B mm	Tooth Count	T mm	Rake (R)	Ring mm	Cross Cut	Rip Cut	Max RPM	Machine	Material
165	B-07886	CSCX16510E	2	20	10	1.2	15°		•	•	9,250	Portable saw	Wood
165	B-07892	CSCX16510G	2	30	10	1.2	15°		•	•	9,250	Portable saw	Wood
165	B-07901	CSCX16516E	2	20	16	1.2	15°		•	•	9,250	Portable saw	Wood
165	B-08006	CSMX16524E	2	20	24	1.2	15°		•	•	9,250	Portable saw	Wood
170	B-07917	CSCX17016G	2	30	16	1.2	15°	15.88	•	•	8,980	Portable saw	Wood
170	B-08012	CSMX17024G	2	30	24	1.2	15°	15.88	•	•	8,980	Portable saw	Wood
180	B-07923	CSCX18016E	2	20	16	1.2	15°		•	•	8,480	Portable saw	Wood
180	B-07939	CSCX18016G	2	30	16	1.2	15°		•	•	8,480	Portable saw	Wood
180	B-08028	CSMX18024E	2	20	24	1.2	15°		•	•	8,480	Portable saw	Wood
180	B-08034	CSMX18024G	2	30	24	1.2	15°		•	•	8,480	Portable saw	Wood
185	B-07945	CSCX18516G	2	30	16	1.2	15°	15.88/20	•	•	8,250	Portable saw	Wood
185	B-08040	CSMX18524G	2	30	24	1.2	15°	15.88/20	•	•	8,250	Portable saw	Wood
190	B-07951	CSCX19012C	2	15.88	12	1.2	15°		•	•	8,040	Portable saw	Wood
190	B-07967	CSCX19012G	2	30	12	1.2	15°	15.88/20	•	•	8,040	Portable saw	Wood
190	B-08056	CSMX19024G	2	30	24	1.2	15°	15.88/20	•	•	8,040	Portable saw	Wood
190	B-08062	CSMX19024C	2	15.88	24	1.2	15°		•	•	8,040	Portable saw	Wood
210	B-07973	CSCX21016G	2.3	30	16	1.4	15°		•	•	7,300	Portable saw	Wood
210	B-08078	CSMX21024G	2.3	30	24	1.4	15°		•	•	7,300	Portable saw	Wood
210	B-08109	CSFX21040G	2.3	30	40	1.4	15°		•	•	7,300	Portable saw	Wood
230	B-07989	CSCX23018G	2.3	30	18	1.6	15°		•	•	6,640	Portable saw	Wood
230	B-08084	CSMX23024G	2.3	30	24	1.6	15°		•	•	6,640	Portable saw	Wood
230	B-08115	CSFX23040G	2.3	30	40	1.6	15°		•	•	6,640	Portable saw	Wood
235	B-07995	CSCX23520G	2.3	30	20	1.6	15°	15.88/25	•	•	6,500	Portable saw	Wood
235	B-08090	CSMX23524G	2.3	30	24	1.6	15°		•	•	6,500	Portable saw	Wood
235	B-08121	CSFX23540G	2.3	30	40	1.6	15°	15.88/25	•	•	6,500	Portable saw	Wood

MULTI PURPOSE SAW BLADES



A wide range of sizes from 160mm – 355mm and tooth counts from 60 to 120 the range covers applications from coarse cutting to extra fine finish work.

- Can cut Aluminium, MDF, PVC, and Laminated Chipboard.
- Easy straight cutting thanks to TCG teeth type, a combination of flat and trapezoidal teeth
- Tungsten Carbide Tipped (TCT)

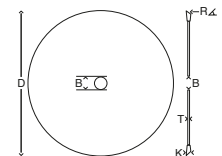
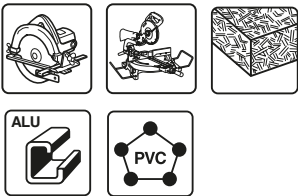

D mm	Part No.	K mm	B mm	Tooth Count	T mm	Rake (R)	Ring mm	Cross Cut	Rip Cut	Max RPM	Machine	Material
160	D-65567	2.2	20	60T	1.4	5°		•		9540	Circular Saw	Multi
165	D-65573	2.2	20	60T	1.4	5°		•		9250	Circular / Mitre	Multi
185	D-65589	2.2	30	60T	1.4	5°		•		8300	Circular Saw	Multi
190	D-65595	2.2	30	60T	1.4	5°		•		8040	Circular / Mitre	Multi
210	D-65604	2.4	30	60T	1.6	5°		•		7170	Circular Saw	Multi
216	D-65610	2.4	30	60T	1.6	5°		•		7070	Mitre Saw	Multi
216	D-65626	2.4	30	80T	1.6	5°		•		7070	Mitre Saw	Multi
235	D-65632	2.4	30	60T	1.6	5°	25.4	•		6500	Circular Saw	Multi
260	D-65648	2.6	30	80T	1.8	5°		•		5870	Mitre Saw	Multi
260	D-65654	2.6	30	100T	1.8	5°		•		5870	Mitre Saw	Multi
260	D-65660	2.6	30	120T	1.8	5°		•		5870	Mitre Saw	Multi
305	D-65676	2.8	30	80T	1.8	5°		•		5000	Mitre Saw	Multi
305	D-65682	2.8	30	100T	2.0	5°		•		5000	Mitre Saw	Multi
305	D-65698	2.8	30	120T	2.2	5°		•		5000	Mitre Saw	Multi
355	D-65707	3.0	30	100T	2.2	5°		•		4300	Mitre Saw	Multi

Batteries & Cases
Tool Holders
Drilling
Fixing
Saw Blades
Jigsaw & Recip
Multi Tool
Diamond
Bonded Abrasives
Flap Discs
Coated Abrasives
Router Cutters
Dust Extraction
Ground Maintenance



A comprehensive selection of circular saw blades for all makes and models of portable circular saw.

A wide range of sizes from 140mm – 355mm and tooth counts from 10 to 60, the range covers applications from coarse rip and cross cutting to extra fine cross cutting.

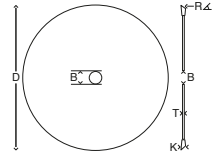

WOOD



- Fully hardened and tensioned blades absorb impact and remain flat and true.
- High grade tungsten carbide with low wear rate for extended blade life.
- Precision honed for a sharper longer lasting edge.
- Thin kerf for less waste and reduced feed pressure.

D mm	Part No.	ID Code	K mm	B mm	Tooth Count	T mm	Rake (R)	Ring mm	Cross Cut	Rip Cut	Max RPM	Machine	Material
140	B-08137	CSC14018C	1.5	15.88	18	1	20°		•	•	10,910	Portable saw	Wood
150	B-08280	CSM15024E	2.4	20	24	1.5	20°		•	•	10,180	Portable saw	Wood
160	B-08143	CSC16016E	2.4	20	16	1.5	20°	15.88	•	•	9,540	Portable saw	Wood
160	B-08296	CSM16024E	2.4	20	24	1.5	20°	15.88	•	•	9,540	Portable saw	Wood
160	B-08420	CSM16040E	2.4	20	40	1.5	20°	15.88	•	•	9,540	Portable saw	Wood
165	B-08159	CSC16510E	2	20	10	1.4	20°		•	•	9,250	Portable saw	Wood
165	B-08165	CSC16510G	2	30	10	1.4	20°		•	•	9,250	Portable saw	Wood
165	B-08305	CSM16524G	2.4	30	24	1.5	20°		•	•	9,250	Portable saw	Wood
165	B-08436	CSM16540G	2.4	30	40	1.5	20°		•	•	9,250	Portable saw	Wood
170	B-08171	CSC17016G	2.4	30	16	1.5	20°	15.88	•	•	8,980	Portable saw	Wood
170	B-08311	CSM17024G	2.4	30	24	1.5	20°	15.88	•	•	8,980	Portable saw	Wood
170	B-08442	CSM17040G	2.4	30	40	1.5	20°	15.88	•	•	8,980	Portable saw	Wood
180	B-08187	CSC18016E	2.4	20	16	1.5	20°		•	•	8,480	Portable saw	Wood
180	B-08193	CSC18016G	2.4	30	16	1.5	20°		•	•	8,480	Portable saw	Wood
180	B-08327	CSM18024E	2.4	20	24	1.5	20°		•	•	8,480	Portable saw	Wood
180	B-08333	CSM18024G	2.4	30	24	1.5	20°		•	•	8,480	Portable saw	Wood
180	B-08458	CSM18040E	2.4	20	40	1.5	20°		•	•	8,480	Portable saw	Wood
180	B-08464	CSM18040G	2.4	30	40	1.5	20°		•	•	8,480	Portable saw	Wood
185	B-08202	CSC18516C	1.8	15.88	16	1.2	20°		•	•	8,250	Portable saw	Wood
185	B-08349	CSM18524C	1.8	15.88	24	1.2	20°		•	•	8,250	Portable saw	Wood
185	B-08470	CSM18540C	1.8	15.88	40	1.2	20°		•	•	8,250	Portable saw	Wood
190	B-08218	CSC19012C	2.2	15.88	12	1.4	20°		•	•	8,040	Portable saw	Wood
190	B-08224	CSC19012G	2	30	12	1.4	20°	15.88/20	•	•	8,040	Portable saw	Wood
190	B-08355	CSM19024G	2.2	30	24	1.4	20°	15.88/20	•	•	8,040	Portable saw	Wood
190	B-08361	CSM19024C	2.2	15.88	24	1.4	20°		•	•	8,040	Portable saw	Wood
190	B-08486	CSM19040G	2.2	30	40	1.4	20°	15.88/20	•	•	8,040	Portable saw	Wood
190	B-08492	CSM19040C	2.2	15.88	40	1.4	20°		•	•	8,040	Portable saw	Wood
190	B-08551	CSXF19060G	2.2	30	60	1.4	15°	15.88/20	•	•	8,040	Portable saw	Wood
210	B-08230	CSC21016G	2.4	30	16	1.6	20°		•	•	7,300	Portable saw	Wood
210	B-08377	CSM21024G	2.4	30	24	1.6	20°		•	•	7,300	Portable saw	Wood
210	B-08501	CSM21040G	2.4	30	40	1.6	20°		•	•	7,300	Portable saw	Wood
230	B-08246	CSC23018G	2.6	30	18	1.6	20°		•	•	6,640	Portable saw	Wood
230	B-08383	CSM23024G	2.3	30	24	1.6	20°		•	•	6,640	Portable saw	Wood
230	B-08517	CSM23040G	2.6	30	40	1.6	20°		•	•	6,640	Portable saw	Wood
230	B-08567	CSXF23060G	2.8	30	60	1.8	15°		•	•	6,640	Portable saw	Wood
235	B-08252	CSC23518G	2.6	30	18	1.6	20°		•	•	6,500	Portable saw	Wood
235	B-08399	CSM23520G	2.3	30	20	1.6	20°		•	•	6,500	Portable saw	Wood
235	B-08408	CSM23524G	2.3	30	24	1.6	20°		•	•	6,500	Portable saw	Wood
235	B-08523	CSM23540G	2.6	30	40	1.6	20°		•	•	6,500	Portable saw	Wood
235	B-08589	CSXF23560G	2.8	30	60	1.8	15°		•	•	6,500	Portable saw	Wood
270	B-08268	CSC27024G	2.6	30	24	1.8	20°		•	•	5,650	Portable saw	Wood
270	B-08539	CSM27040G	2.6	30	40	1.6	20°		•	•	5,650	Portable saw	Wood
270	B-08573	CSXF27060G	2.8	30	60	1.8	15°	20	•	•	5,650	Portable saw	Wood
355	B-08274	CSC35524G	3	30	24	2.2	20°		•	•	4,300	Portable saw	Wood
355	B-08414	CSM35540G	3	30	40	2.2	20°		•	•	4,300	Portable saw	Wood
355	B-08545	CSM35560G	3	30	60	2.2	20°		•	•	4,300	Portable saw	Wood
355	B-08595	CSXF35560G	2.8	30	60	1.8	15°		•	•	4,300	Portable saw	Wood

SAW BLADES

STANDARD BLADES



D mm	Part No.	ID Code	K mm	B mm	Tooth Count	T mm	Rake (R)	Ring mm	Cross Cut	Rip Cut	Max RPM	Machine	Material
STANDARD BLADES FOR PORTABLE SAWS													
160	D-16433		2.4	20	16	1.5	20°	16	•	•	9,540	Portable saw	Wood
165	D-03327		2.4	20	10	1.5	20°		•	•	9,250	Portable saw	Wood
165	D-03333		2.4	20	24	1.5	20°		•	•	9,250	Portable saw	Wood
165	D-03349		2.4	20	40	1.5	20°		•	•	9,250	Portable saw	Wood
185	D-03903		1.8	30	16	1.2	20°	16/20	•	•	8,250	Portable saw	Wood
185	D-03919		1.8	30	40	1.2	20°	16/20	•	•	8,250	Portable saw	Wood
235	D-03925		2.3	30	20	1.6	20°	25	•	•	6,500	Portable saw	Wood
235	D-03931		2.3	30	48	1.6	20°	25	•	•	6,500	Portable saw	Wood
235	D-09640		2.3	30	60	1.6	20°	25	•	•	6,500	Portable saw	Wood
305	A-87579		1.95	25.4	76		-6°				1,500	LC1230	Stainless
STANDARD BLADES FOR PORTABLE SAWS - PACKS OF 3 BLADES													
165	D-44753		2.4	20	16,24,40	1.5	20,20,18°	16	•	•	9,250	Portable Saw	Wood
235	D-44775		2.3	30	20,48,60	1.6	20	25	•	•	6,500	Portable Saw	Wood
STANDARD BLADES FOR STATIONARY SAWS													
260	D-46408		2.4	30	60	1.8	15		•		5,870	Mitre saw	Wood
260	D-03969		2.3	30	70	1.8	0°	15.88	•		5,870	Mitre saw	Wood/Alu
260	D-03975		2.3	30	100	1.8	-5°	15.88	•		5,870	Mitre saw	Alu

MAKBLADE FOR STATIONARY SAWS



A comprehensive selection of saw blades for all makes and models of Mitre Saws and Slide Compound Mitre Saws, including cordless saws.



A wide range of sizes from 190mm – 305mm and tooth counts from 24 to 100 the range covers applications from coarse cutting to extra fine finish work.

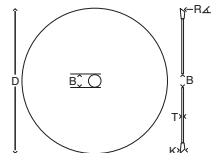

- Fully hardened and tensioned blades absorb impact and remain flat and true.
- High grade tungsten carbide with low wear rate for extended blade life.
- Precision honed tips for a sharper longer lasting edge.
- Thin kerf for less waste and reduced motor pressure.

D mm	Part No.	ID Code	K mm	B mm	Tooth Count	T mm	Rake (R)	Ring mm	Cross Cut	Rip Cut	Max RPM	Machine	Material
190	B-08894	MSC19024E	2.2	20	24	1.6	5°		•		8,040	Mitre saw	Wood
190	B-08953	MSM19048E	2.2	20	48	1.6	5°		•		8,040	Mitre saw	Wood
190	B-09042	MSF19060E	2	20	60	1.4	5°		•		8,040	Mitre saw	Wood
216	B-08903	MSC21624G	2.4	30	24	1.6	5°		•		7,070	Mitre saw	Wood
216	B-08872	CMSM21640G	2.1	30	40	1.6	10°		•		7,070	Mitre saw	Wood
216	B-39506	MSM21648G	2.4	30	48	1.6	5°		•		7,070	Mitre saw	Wood
216	B-08969	MSM21648G	2.4	30	48	1.6	5°		•		7,070	Mitre saw	Wood
216	B-09058	MSF21660G	2	30	60	1.4	5°		•		7,070	Mitre saw	Wood
216	B-09092	MSXF21680G	2.8	30	100	1.8	5°		•		7,070	Mitre saw	Wood
250	B-08919	MSC25032G	2.4	30	32	1.6	5°		•		6,110	Mitre saw	Wood
250	B-08975	MSM25048G	2.4	30	48	1.8	5°		•		6,110	Mitre saw	Wood
250	B-09008	MSM25060G	2.3	30	60	1.8	5°		•		6,110	Mitre saw	Wood
250	B-09064	MSF25072G	2.4	30	72	1.8	5°		•		6,110	Mitre saw	Wood
250	B-09101	MSXF250100G	2.3	30	100	1.8	5°		•		6,110	Mitre saw	Wood
255	B-08925	MSF25532G	2.3	30	32	1.8	5°		•		5,990	Mitre saw	Wood
255	B-08888	CMSM25548G	2.1	30	48	1.6	10°		•		5,990	Mitre saw	Wood
255	B-09014	MSM25560G	2.3	30	60	1.8	5°		•		5,990	Mitre saw	Wood
260	B-08931	MSM26032G	2.3	30	32	1.8	5°		•		5,870	Mitre saw	Wood
260	B-08981	MSM26040G	2.3	30	40	1.8	5°		•		5,870	Mitre saw	Wood
260	B-09020	MSM26060G	2.3	30	60	1.8	5°		•		5,870	Mitre saw	Wood
260	B-09070	MSF26080G	2.3	30	80	1.8	5°		•		5,870	Mitre saw	Wood
260	B-09117	MSXF260100G	2.3	30	100	1.8	5°		•		5,870	Mitre saw	Wood
305	B-08947	MSC30532G	2.3	30	32	1.8	5°		•		5,000	Mitre saw	Wood
305	B-08997	MSM30540G	2.3	30	40	1.8	5°		•		5,000	Mitre saw	Wood
305	B-09036	MSM30560G	2.3	30	60	1.8	5°		•		5,000	Mitre saw	Wood
305	B-09086	MSF30580G	2.3	30	80	1.8	5°		•		5,000	Mitre saw	Wood
305	B-09123	MSXF305100G	2.3	30	100	1.8	5°		•		5,000	Mitre saw	Wood
315	B-46171	TSC31528G	2.8	30	28	2	20°		•		4850	Sitesaw	Wood
315	B-46187	TSM31548G	2.8	30	48	2	10°		•		4850	Sitesaw	Wood
315	B-46193	TSF21560G	2.8	30	60	2	10°		•		4850	Sitesaw	Wood



MAKBLADE PLUS

CARBIDE-TIPPED BLADE WITH ANTI-RUST COATING

The Makblade Plus saw blades for Mitre and Table saws have unique patented technology.

Developed to dampen vibration and be super quiet these blades enhance the working environment and improve both durability of the saw blade and equipment reliability. A lower vibrating blade produces greater cut accuracy and also reduces wobble, giving a beautiful cut surface. This also significantly extends the life of the tungsten carbide teeth beyond that of conventional carbide tipped saw blades.

- Vibration dampening system featuring resin bond filled laser cut body slots.
- Precision plate tensioning for a flatter blade and truer cuts.
- Ultra low friction coating for effortless cutting and protection from corrosion.

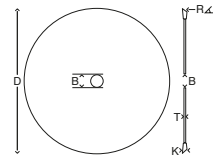

D mm	Part No.	ID Code	K mm	B mm	Tooth Count	T mm	Rake (R)	Ring mm	Cross Cut	Rip Cut	Max RPM	Machine	Material
165	B-56502	CMSXF16564EL	1.9	20	64	1.4	10°		•		9,250	Cordless, Mitre	Wood
190	B-08604	MSC19024EL	2.2	20	24	1.6	5°		•		8,040	Mitre saw	Wood
190	B-08757	MSF19060EL	2	20	60	1.4	5°		•		8,040	Mitre saw	Wood
200	B-09802	TSM20036GL	2.6	30	36	1.6	20°		•	•	7,630	Table saw	Wood
200	B-08822	TSF20060GL	2.6	30	60	1.6	15°		•	•	7,630	Table saw	Wood
216	B-08610	MSC21624GL	2.4	30	24	1.6	5°		•		7,070	Mitre saw	Wood
216	B-08632	MSM21648GL	2.4	30	48	1.6	5°		•		7,070	Mitre saw	Wood
216	B-08676	MSM21660GL	2.1	30	60	1.6	5°		•		7,070	Mitre saw	Wood
216	B-08791	MSXF21680GL	2.8	30	80	1.8	5°		•		7,070	Mitre saw	Wood
250	B-09818	TSM25040GL	2.8	30	40	1.8	20°		•	•	6,110	Table saw	Wood
250	B-08838	TSF25080GL	2.8	30	80	1.8	15°		•	•	6,110	Table saw	Wood
255	B-08626	MSC25532GL	2.3	30	32	1.8	5°		•		5,990	Mitre saw	Wood
255	B-08648	MSM25540GL	2.4	30	40	1.8	5°		•		5,990	Mitre saw	Wood
255	B-08682	MSM25560GL	2.3	30	60	1.8	5°		•		5,990	Mitre saw	Wood
255	B-08763	MSF25572GL	2.4	30	72	1.8	5°		•		5,990	Mitre saw	Wood
260	B-04999		2.3	30	24	1.8	20°				5,870	Table saw	Wood
260	B-05072		2.3	30	40		20°				5,870	Table saw	Wood
260	B-08654	MSM26040GL	2.3	30	40	1.8	5°		•		5,870	Mitre saw	Wood
260	B-09824	TSM26040GL	2.8	30	48	1.8	20°		•	•	5,870	Table saw	Wood
260	B-08698	MSM26060GL	2.3	30	60	1.8	5°		•		5,870	Mitre saw	Wood
260	B-08707	MSM26070GL	2.3	30	70	1.8	5°		•		5,870	Mitre saw	Wood
260	B-08779	MSF26080GL	2.3	30	80	1.8	5°		•		5,870	Mitre saw	Wood
260	B-08844	TSF26080GL	2.8	30	80	1.8	15°		•	•	5,870	Table saw	Wood
260	B-08800	MSXF260100GL	2.3	30	100	1.8	5°		•		5,870	Mitre saw	Wood
300	B-09830	TSM30048GL	2.8	30	48	1.8	20°		•	•	5,090	Table saw	Wood
300	B-08850	TSF300100GL	2.8	30	100	1.8	15°		•	•	5,090	Table saw	Wood
305	B-08660	MSM30540GL	2.3	30	40	1.8	5°		•		5,000	Mitre saw	Wood
305	B-08713	MSM30560GL	2.3	30	60	1.8	5°		•		5,000	Mitre saw	Wood
305	B-08729	MSM30560GLA	2.6	30	60	2	5°		•		5,000	Mitre saw	Wood
305	B-08735	MSM30570GL	2.5	30	70	1.9	0°		•		5,000	Mitre saw	Wood
305	B-08785	MSF30580GL	2.3	30	80	1.8	5°		•		5,000	Mitre saw	Wood
305	B-08816	MSXF305100GL	2.3	30	100	1.8	5°		•		5,000	Mitre saw	Wood
350	B-09846	TSM35056GL	3.5	30	56	2.5	20°		•	•	4,360	Table saw	Wood
350	B-08866	TSF350100GL	3	30	100	2	15°		•	•	4,360	Table saw	Wood
355	B-08741	MSM35580GL	3	30	80	2.2	5°		•		4,300	Mitre saw	Wood
LONG LIFE - MDF													
165	B-53198	CCM16544EL	1.45	20	44	1	23°				6,500	Cordless	MDF, lam
250	B-42640	TSF25080G	2.6	30	80	1.8	5°			•	6,110	Table saw	MDF
300	B-42656	TSF25080G	2.6	30	96	1.8	5°			•	5,090	Table saw	MDF
250	B-42830	TSF25080G	3.2	30	80	2.2	5°			•	6,110	Large machinery	MDF
300	B-42846	TSF30096G	3.2	30	96	2.2	5°			•	5,090	Large machinery	MDF
FINE FINISH - MDF													
250	B-42662	TSXF25080G	2.6	30	80	1.8	-5°			•	6,110	Table saw	MDF
300	B-42678	TSXF30096G	2.6	30	96	1.8	-5°			•	5,090	Table saw	MDF
250	B-42852	TSXF25080G	3.2	30	80	2.2	-5°			•	6,110	Large machinery	MDF
300	B-42868	TSXF30096G	3.2	30	96	2.2	-5°			•	5,090	Large machinery	MDF

SAW STANDS

ADJUSTABLE WHEELED STAND

DEAWST06

- For LS0714, LS0815, LS1016, LS1018, LS1216, LS1040, DLS713 and MLS100
- Lightweight aluminium frame
- Leveling foot to prevent wobbling
- Adjustable side extension
- Extension arm with roller
- Tool-less removal of mitre saw
- Carry handle
- Caster for easy transportation
- Dimensions: 1,150mm (L) x 750mm (W) x 850mm (H)



ADJUSTABLE WHEELED STAND

DEAWST05

- For all mitre saws
- 2 heights 55cm / 80cm
- Adjustable side extensions
- Weight: 30kg
- Folds flat for easy storage and transport without disassembling the machine.



ADJUSTABLE WHEELED STAND

198687-1

- For all mitre saws
- 5 settings for working height adjustment
- Height Settings: 660,700,760,800,840mm
- Pre Drilled to fit all Makita Mitre Saws
- Collapsing stand with shock absorbers
- Can be positioned vertically for easy and compact storage
- Material support and rollers
- Wheels for easy transportation
- Tubular aluminium construction
- "Tread kickers" provide extra leverage when loading or unloading saw



WHEELED STAND

194093-8

- For the 2704
- Collapsible stand
- 5 level height adjustment
- Material supports and rollers
- Heavy duty wheels
- Adjustable foot supports
- Tubular aluminium construction



WHEELED STAND

JM27000300

- For the MLT100
- Adjustable feet for extra stability
- Foldable for storage and transport.
- Heavy duty wheels



STAND

194043-3

- For the LS1214 and LS0714
- Adjustable feet for extra stability
- Foldable for storage and transport.



THICKNESSER STAND

198689-7

- For the 2012NB and 2012NBX
- Adjustable feet for extra stability
- Foldable for storage and transport



ROBUST STEEL STAND

P-35396

- For the LS1013 and LS1040
- Foldable for storage and transport
- H86.5m x W57cm x L69cm



ROLLER SUPPORT

P-35411

- Metal frame with roller
- Adjustable from 700mm - 1200mm



UTILITY BENCH

A-06040

- Metal frame with folding legs and a wooden top
- Side handle for easy transportation
- H84cm x W60cm x L120cm



REPLACEMENT PARTS

95C625: Replacement rubber feet for P-35396

JM23610050: Bracket set for DEAWST06 stand

SAW BLADES: ACCESSORIES

Part No.	Details	Model
----------	---------	-------



GUIDE RULES (RIP FENCE)



164113-2	Guide Rule	4300BA, 4300BV
192732-4	Guide Rule	4323
164095-8	Guide Rule	BHS630, BSS550, BSS501, BSR730, BSS610, BSS611, 5008MG, 5604R, 5704R
165108-8	Guide Rule	5703R, 5603R, 5017RKB
165084-6	Guide Rule	5103R, 5903R
316840-9	Guide Rule	LS1013
165447-6	Guide Rule	SP6000
193516-3	Guide Rule	4340
196994-6	Guide Rule	HS7601
165153-3	Guide Rule	DRS780



RIP FENCE TABLE SAW



122739-6	Rip Fence	2704
122707-9	Rip Fence	LH1040
122729-9	Rip Fence	LF1000



MITRE GUIDE



122735-4	Mitre Guide	2704
122730-4	Mitre Guide	LF1000



Horizontal Vice



Vertical Vice

VICE ASSEMBLIES



122571-8	Vertical Vice	LS0714, DLS713
122538-6	Vertical Vice	LS1214, LS1013
192625-5	Vertical Vice	LH1040
122536-0	Vertical Vice	LF1040
122854-6	Vertical Vice	LS1016, LS1216
JM23100502	Vertical Vice	LS1018L, LH1200F
122563-7	Horizontal Vice	LS0714, DLS713, LS1040, LH1040
122470-4	Horizontal Vice	LS1016
122930-6	Horizontal Vice	LS1216, LS1018
134733-6	Horizontal Vice Quick Release	2414B/NB

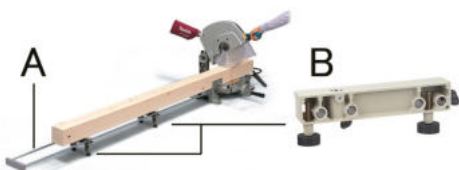

HOLDER ASSEMBLY FOR SUPPORTING LONG STOCK



196123-1	Holder Set	DLS713, DLS714
122446-1	Holder	LS1040, LH1040
192671-8	Holder	LS1013, LS1018, LS1214
256812-1	Extension Rod	



HOLDER SET U SUPPORT BARS



195240-4	Holder 2pc inc thumb screws	LS1016, LS1216
192621-3	Holder 2pc inc thumb screws	LS0714, LS1040, LH1040, BLS713



STOPPER SET



192622-1	Crown moulding stopper	LS1040, LH1040
192669-5	Crown moulding stopper	LS1016
195253-5	Crown moulding stopper	LS1216



SUB PLATE REAR SUPPORT



195934-1	Sub Plate	LS1040
122716-8	Sub Plate	LH1040

SAW BLADES: ACCESSORIES

Part No.	Details	Model
----------	---------	-------



SET PLATE (UNIFORM CUTTING WIDTH)



122472-0	Set plate	LS0714, LS1040, LH1040, BLS713
----------	-----------	--------------------------------



SUB FENCE FOR MITRE SAWS



153896-9	Sub fence complete	LS1013, LS1214
142816-8	Sub fence complete	LS1040F
JM23200110	Sub fence complete	LS1018



CIRCULAR CUTTING GUIDE



123030-5	Circular guide assembly	4300BV
193516-3	Guide rule and circular guide	4350, 4351, BJV180, BJV140
192561-5	Circular guide assembly	4304T, 4331, 4333
JM21000320	Circular cutting set	LB1200F



EXTENSION TABLES



194087-3	Rear Extension Table	2704
194086-5	Left Extension Table	2704
JM21000300	Extension Table set	LB1200F



KERF



151917-1	Replacemet Kerf block	LS1013, LS1214
415209-5	Kerf Board each	LS1013, LS1214
416001-2	Kerf Board each	LS1040, LH1040
451201-7	Kerf Board each	LS1216
417993-8	Kerf Board each	LS0714
451013-8	Kerf Board each	LS1016
JM23100029	Kerf Board	LS1018



BELT SANDING ATTACHMENT



JM21000330	Belt sanding set	LB1200F
------------	------------------	---------



SAFETY BUTTON AND LIGHT SET



411478-6	Safety Switch Button	2708
417113-4	Switch Button	2414B, 2414NB, DLS713
193730-1	Flourescent Light Set	LS1040F

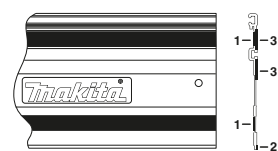

Clamp Set

Bevel Guide Set

GUIDE RAILS



199140-0	Guide rail 1000mm	
199141-8	Guide rail 1500mm	SP6000, RP2301
194367-7	Guide rail 2x 1500mm	SP6000, RP2301
B-57613	Guide rail bag 1500mm	
B-66905	Guide rail bag 1000mm	
P-45777	Guide rail connector x1	SP6000, RP2301
P-20177	Guide rail connector x2	SP6000, RP2301
192505-5	Guide rail adaptor	5603R, 5703R
193517-1	Guide rail adaptor	4350T, 4351, DJV140, DJV180, DJV181, DJV182
197252-3	Guide rail adaptor	HS6100, HS6101, HS7100, HS7101, DHS630
194579-2	Router adaptor	RP0910, RP1110C, RP1800, RP1801, RP1800F, RP1801F, RP2300FC, 3612, 3612BR, RT0700C, RP2301, RP1801
192506-3	Guide rail adaptor	5903R
197005-0	Guide rail adaptor	HS7601
413102-7	(1) Running strips 3m	Base
423360-7	(2) Splinter guide 3m	Edge
423362-3	(3) Guide rail seat 3m	
194385-5	Clamp set	SP6000, RP2301
196664-7	Adjustable bevel guide	SP6000, RP2301
195841-8	Rule bar set	DHS630
192507-1	Guide rail adaptor	5103R
196953-0	Guide rail adaptor	DHS680

Batteries & Cases
Tool Holders
Drilling
Fixing
Saw Blades
Jigsaw & Recip
Multi Tool
Diamond
Bonded Abrasives
Flap Discs
Coated Abrasives
Router Cutters
Dust Extraction
Ground Maintenance

JIGSAW BLADES

JIGSAW BLADES UNIVERSAL FITTING



Many of our jigsaw blades are manufactured using superb quality Japanese steel. They cover a very broad spectrum of applications in wood and metal, including: Down cutting and 2-way cutting for work top and laminates, Fast and clean cutting in timber, Nail embedded wood, Ferrous and non-ferrous metals, Cladding, Fibreglass, Stainless steel and many more.



Part No.	Number		Quantity	Length	Plywood	Plastics	Aluminium	Stainless	Mild Steel	Teeth Per Inch	Blade Material	
BASIC CUT - WOOD												
A-85656	B13		B-07705 - 100 Pieces	5	80	4-65	4-65			8	HCS	
A-85678	B15			5	50	3-35	3-35			12	HCS	
A-85709	B18			5	45	2-35	2-35			14	HCS	
D-34877				5	74	4-50	4-50			8	HCS	
CLEAN CUT - WOOD												
A-85662	B14			5	50	2-35				18	HCS	
A-85628	B10			5	76	2-61	2-61			10	HCS	
A-85634	B11		B-07680 - 100 Pieces	5	75	3-60	3-60			9	HCS	
A-85640	B12		B-07696 - 100 Pieces	5	75	5-65	5-65			6	HCS	
A-85690	B17			5	70	5-60	5-60			6	HCS	
A-85715	B19			5	65	3-50	3-50			12 (Down)	HSS	
A-80400	B29			5	42	2-35	2-35			16	HCS	
D-44214				5	74	4-50	4-50			9	HCS	
B-04933	B19S			5	43	3-25	3-25			12	HCS	
SPEED CUT - WOOD												
A-86315	L10			5	155	5-145				7	HCS	
A-85684	B16			5	75	5-65	5-65			6	HCS	
A-86309	L2			5	100	5-90	5-90			6	HCS	
792726-5	B16L			5	150	5-135	5-135			6	HCS	
D-34883				5	74	4-50	4-50			6	HCS	
D-34899				5	74	4-50	4-50			6	HCS	
BASIC CUT - METAL												
A-85737	B22			5	50		1-6	1-3	1-3	1-3	24	HSS
A-85743	B23		B-07749 - 100 Pieces	5	50	3-35	3-35	2-6		2-6	14	HSS
A-85759	B24			5	50		1-3	1-2	0.5-2	0.5-2	32	HSS
A-85771	B26			5	70	3-60	3-60	3-10		3-10	9	HSS
A-85787	B27			5	50		1-6	1-3	1-3	1-3	24	HSS
B-10453	B34			5	50		1.5-6	1.5-3	1.5-3	1.5-3	18	HSS
B-10447	B33			5	107		<65mm	<65mm	2-3		14	HSS
A-85721	B21			5	75		3-60	3-60			12	HSS
D-34908				5	51			1-3	1-3		21	HSS
FLEXIBLE CUT - METAL												
P-47204				5	105					1-1.8	25	Bi-Metal
B-10469	B35			5	154					14.	14	Bi-Metal
P-47210				5	105					2.5-6	14	Bi-Metal
SPECIALIZED												
A-85793	BR13			5	64	5-65				9 (2-way)	HCS	
A-85765	B25			5	75	3-60	3-60	3-6		3-6	9	HSS
P-38788				3	50						30q TC Grit	
P-38794				3	50						50q TC Grit	
P-38766				3	75					6		
P-05929				1	50			0-2.5	0-2.5	23		
P-49622				5	75	3-60	3-60			2.5-6	9-10	Bi-Metal
P-49644				5	155	5-145	5-145			2.5-6	24	Bi-Metal
P-38772				3	105					6		
A-80416	BK			5	75							HCS
P-49638				5	105	5-90	5-90			2.5-6	9-10	Bi-Metal
B-10431	B32			5	107		<65mm	<65mm		1.5-3	18	HSS
B-10970	B53			5	82.6						15	Bi-Metal
B-10986	B54			5	82.6						15	Bi-Metal

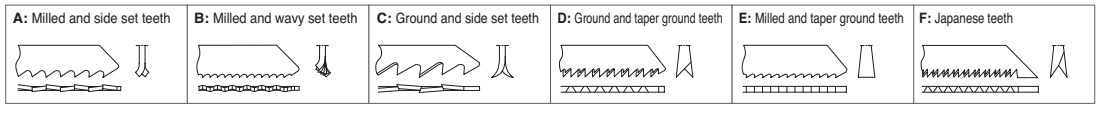

Teeth Type	Details		Boosh Equiv.	Part No.
BASIC CUT - WOOD				
A	For general cutting of wood and plastics.		T111C	A-85656
B	Hardboard & fibreboard to 3mm hardwood, plastics & ply to 35mm		T119B	A-85678
A	Ideal for curve cutting of wood and plastics. (Scroll cutting)		T119BO	A-85709
A	Designed as an economical blade with good compromise of cutting performance		T111C	D-34877
CLEAN CUT - WOOD				
B	Hardboard & fibreboard to 8mm hardwood, plastics & ply to 35mm. (Fast cutting)		T101AOF	A-85662
D	Fast fine cut in wood and plastics, especially suited to plywood		T101D	A-85628
D	For fast finish work in wood and plastics. Clean cut		T101BO	A-85634
D	For fast finish work in wood and plastics. Clean cut		T101D	A-85640
C	Ideal for curve cutting of wood and plastics (fast cutting)		T101AO	A-85690
D	For laminated wood and decorative veneer finishing. (Reverse tooth pattern)		T101BR	A-85715
D	Ideal for scroll cutting of wood and plastics (finishing)		T101AO	A-80400
D	Fine teeth setting for clean cut in wood or plastics		T101B	D-44214
D	Splinter-free, clean and straight sawing in veneered work tops, wood, multi- and plywood and plastics			B-04933
SPEED CUT - WOOD				
C	All types of wood. (Fast rough cut)		T744D	A-86315
C	For fast cutting of wood and plastics. (Fast rough cut)		T144D	A-85684
C	Ideal for fast cutting of thick materials.		T301CD	A-86309
C	Ideal for cutting thick materials. (Fast cut)		T744D	792726-5
C	Ideal for fast cutting of medium/thick work pieces		T144D	D-34883
C	Ideal for general and curved cuts		T244D	D-34899
BASIC CUT - METAL				
B	For mild steel, stainless steel and tough plastics, especially suited for thin plate		T118A	A-85737
B	Mild steel, medium thick metal plate, wood, decorative veneers. Non-ferrous		T118B	A-85743
B	For thin mild steel, stainless steel, very thin metal plate		T118G	A-85759
A	For curve cutting in hardwoods, metal and plastics		T318B	A-85771
B	For curve cutting and scroll in mild steel. Non-ferrous		T218A	A-85787
B	For mild steel, tough plastics. Especially thin metal plate		T118A	B-10453
A	For medium-thick metal plate, pipes and profiles. Also aluminium		T318B	B-10447
E	For finish work in plastics and aluminum		T101A	A-85721
B	HSS blade designed for metal cutting		T118A	D-34908
FLEXIBLE CUT - METAL				
B	For cladding to 80mm and sandwich material. (Flexible blade)		T318AF	P-47204
E	For sandwich materials. (extra long for deep profiles)		T718BF	B-10469
B	Thin sheet metal pipe non-ferrous and cladding		T318BF	P-47210
SPECIALIZED				
A	Splinter-free cuts in wood, requiring no sanding. Up and down cut blade for finish on top surfaces			A-85793
A	For hardwood, thick mild steel plate and tough plastics. Tungsten carbide grit tooth		T127D	A-85765
N/A	Ceramics 5-15mm coarse		T130RIFF	P-38788
N/A	Ceramics 5-20mm fine		T150RIFF	P-38794
TC Teeth	Ideal for glass fibre and reinforced plastics. TCT teeth for very long tough materials		T141HM	P-38766
TC Teeth	Sheet steel and stainless		T118AHM	P-05929
Variable	Ideal for wood with nails		T345XF	P-49622
B	Ideal for thick cladding material		T718BF	P-49644
TC Teeth	Ideal for glass fibre and reinforced plastics		T341HM	P-38772
N/A	Ideal for cutting of paper, cork, rubber and leather		T113A	A-80416
Variable	Ideal for wood with nails			P-49638
A	For thin metal plate, pipes and profiles. Also aluminium and plastics		T318AF	B-10431
D	Straight cut in laminates, wooden flooring and decorative woods. (Splinter free)		T101BIF	B-10970
D	Scroll cut in laminates, wooden flooring and decorative woods. (Splinter free)		T101AOF	B-10986

Batteries & Cases
Tool Holders
Drilling
Fixing
Saw Blades
Jigsaw & Recip
Multi Tool
Diamond
Bonded Abrasives
Flap Discs
Coated Abrasives
Router Cutters
Dust Extraction
Ground Maintenance

JIGSAW BLADES

JIGSAW BLADES UNIVERSAL FITTING



Part No.	Number	Quantity	Length	Plywood	Plastics	Aluminium	Stainless	Mild Steel	Teeth Per Inch	Blade Material	
SUPER EXPRESS											
B-06460	B50		5	77	5-50	5-50			8.5-10.6	HCS	
B-06476	B51		5	77			1-3	1-8	9.8-18.1	HCS	
B-06482	B52		5	77	5-50	5-50	3.35	3-5	3-8	5.5-9.8	HCS
SELECTION PACKS											
B-06292	MIX		3	75	2-65	2-65			2-3	HCS	
A-86898	MIX		5								

JIGSAW BLADE SET 10PC

B-44410

Wood and Metal Blades



Length: 50 - 75mm
2x B-10S, 2x B-16, 2x B-13,
2x B-23, 2x B-22

Master Carton: 30

JIGSAW BLADE SET 10PC

B-44426

Super Express and Laminate Blades



Length: 60 - 77mm
4x B-50, 2x B-51, 2x B-52, 2x B-53

Master Carton: 30

JIGSAW BLADES MAKITA FITTING



Part No.	Number	Quantity	Length	Plywood	Plastics	Aluminium	Stainless	Mild Steel	Teeth Per Inch	Blade Material	
WOOD											
A-85868	3		5	60	3-50				9	HCS	
A-85911	8		5	60	4-50	4-50			8	HCS	
A-85818	10		5	60	4-50	4-50			9	HCS	
A-85830	16		5	60	3-50	3-50			9	HCS	
A-85846	17		5	63	2-50	2-50	2-6	2-6	14	HSS	
A-85880	41		5	60	3-50	3-50			12	HCS	
A-85896	42		5	60	2-50	2-50			16	HSS	
A-85933	BR3		5	60	4-50				9	HCS	
METAL											
A-85802	1		5	60		1-6	1-3	0.5-3	1-3	24	HSS
A-85905	5		5	42		1-6	1-6		1-3	24	HSS
SPECIALIZED											
A-85852	2		5	60	3-50	3-50	2-6	2-6	14	HSS	
A-85874	4		5	60	3-50	3-50	3-6	3-6	9	HSS	

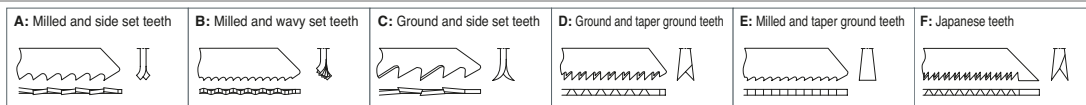

Teeth Type	Details		Bosch Equiv.	Part No.
SUPER EXPRESS				
D	Super express superior performance with cordless saws: Wood.		T123X	B-06460
B	Super express superior performance with cordless saws: Metal.		T345X	B-06476
B	Super express superior performance with cordless saws: Universal.		T345X	B-06482
SELECTION PACKS				
Variable	Super express superior performance with cordless saws. Selection pack 1 x B50 1 x B51 1 x B52.			B-06292
	Selection pack 1 x B22, 1 x B23, 1 x B13, 1 x B16, B10S			A-86898

JIGSAW BLADE SET 5PC B-48527

Super Express and Laminate Blades

Length: 60 - 77mm
2x B-50, 1x B-51, 1x B-52, 1x B-53

Master Carton: 80

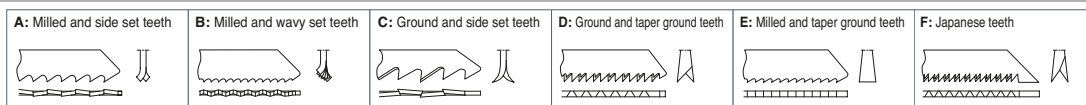

Teeth Type	Details		Part No.
WOOD			
A	For general cutting of wood.		A-85868
C	For fast cutting of wood and plastics.		A-85911
D	For fast finish work, especially in plywood.		A-85818
A	Ideal for scroll cutting of wood and plastics.		A-85830
A	Ideal for scroll cutting of decorative veneer.		A-85846
D	For tough plastics and decorative veneers finishing. Reverse tooth for fine finish on top surface of material.		A-85880
D	Straight sawing in laminate, wood, laminated sheets, hardwood, plywood, trespas, chipboard and plastics		A-85896
A	Splinter-free cuts in wood requiring no sanding.		A-85933
METAL			
B	For mild steel. Suitable for corrugated plastics and tough plastics.		A-85802
B	For mild steel.		A-85905
SPECIALIZED			
A	Mild steel, wood, plywood and plastics 3-55mm.		A-85852
A	For hardwood, thick mild steel plate and tough plastics.		A-85874

RECIPROCATING SAW BLADES

RECIPROCATING BLADES



Part No.		Quantity	Length	Plywood	Plastics	Aluminium	Stainless	Mild Steel	Teeth Per Inch	Blade Material
FLEXIBLE CUT - METAL										
P-04911		5	150mm			3-8	3-8	3-8	14	Bi-metal
P-04880		5	150mm			1.5-4	1.5-3	1.5-4	18	Bi-metal
P-04905		5	150mm			1.5-4	1.2-3	1.5-4	24	Bi-metal
792146-3		5	125mm			2-8		2-8	24	HSS
792147-1		5	165mm			1-3		1-3	18	HSS
792149-7		5	165mm			0.7-3		0.7-3	24	HSS
WOOD										
P-04999		5	150mm	3-30					4	HCS
P-05000		5	150mm	5-100					10	HCS
P-05022		5	150mm	3-30	3-75				6	HCS
D-53089		2	150mm						6	HCS
P-05072		5	300mm	3-250					4 to 5	HCS
792148-9		5	165mm	6-60	6-100				9	HCS
B-03030		5	300mm	3-250	6-200				6	HCS
B-56596		1	225mm	1.7-100	1.7-100				15	HCS
B-57392		1	225mm	1.7-140	1.7-140				15	Bi-Metal
B-57386		1	190mm	3-140					8.5	Bi-Metal
B-62016		1	250mm	3-160					8.5	HCS
B-56580		1	190mm	3-100					8.5	HCS
P-05016		5	300mm	10-250					6	HCS
SPECIALIZED										
P-45680		5	150mm			0.5-3		0.5-3	8	Bi-metal
P-04983		5	280mm			3-12	3-12	3-12	10	Bi-metal
P-04927		5	200mm				2.8	2.8	14	Bi-metal
P-04933		5	200mm				1.5-4	1.5-4	18	Bi-metal
P-05088		5	150mm	9.5-80	9.5-80			1.5-3	6	Bi-metal
P-05044		1	150mm	10-100	8-50	8-50			6	TCT
B-23248		5	300mm						6	Bi-metal
B-23254		5	300mm						10	Bi-metal
B-10394		1	305mm						2	TC/HM
B-10403		1	455mm						2	TC/HM
B-52118		2	225mm							HCS
B-52124		2	300mm							HCS
B-52130		1	400mm							HCS
B-51312		2	203mm				5-125		18	TC/HM
B-12809		1	240mm						2	TC/HM
RESCUE AND DEMOLITION										
P-47189		5	150mm	1-100				3-8	10-14	Bi-metal
P-49529		5	200mm	1-150				3-8	10-14	Bi-metal
P-47195		5	220mm	1-180				3-8	10-14	Bi-metal
723076A3		3	230mm						6	Bi-metal
B-67206		25	152mm						6-8	TC/HM
B-67212		25	228mm						6-8	TC/HM
SUPER EXPRESS										
B-05153		5	203mm	6-150	2.5-150				6-10	HCS
B-05038		5	152mm		5-77	5-77		1-8	17-18	Bi-metal
B-05044		5	152mm	5-77	5-77			5-8	6-11	Bi-metal
B-10637		3	305mm	10-250	5-60				5-8	Bi-metal
B-13677		3								Bi-metal

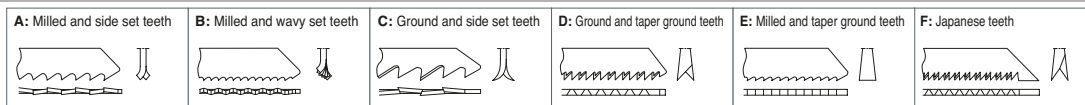

Teeth Type	Details	Bosch Equiv.	Part No.
METAL FLEXIBLE CUT			
B	Metal Cutting: Steel, stainless steel, alloys, cast iron. Wood with nails, pallet cutting, steel pipe 3-8mm.	S922BF	P-04911
B	Metal Cutting: Steel, stainless steel, alloys, cast iron. Wood with nails. Steel pipe 1.5-3mm section.	S922EF	P-04880
B	Steel, stainless steel, cast iron, alloys, steel pipe 1.2-2mm section.	S922EF	P-04905
B	Metal Cutting: Steel plate less than 3mm. Iron pipe less than 50mm diameter.	S918B	792146-3
B	Metal Cutting: Thin wall pipe less than 2mm thick, steel plate and aluminium more than 3mm, iron pipe 90mm diameter or less.	S918E	792147-1
B	Metal Cutting: Thin wall pipe less than 2mm thick, Steel Plate less than 3mm, iron pipe 50mm diameter or less.	S922AF	792149-7
WOOD			
C	Wood cutting, green wood, pallets.	S811H	P-04999
	Wood cutting <100mm	S811H	P-05000
C	Very quick cutting blade: Wood and plastics, Polystyrene foam. Suitable for curves and bevels.	S6110	P-05022
C	Wood cutting <100mm		D-53089
C	For coarse cutting; tree cutting, pruning etc.	S1531L	P-05072
A	Wood cutting: less than 90mm. Up to 100mm plywood, plastics, plunge cutting.	S664D	792148-9
C	For roughing work on thick wood.	S1344D	B-03030
F	Wood, PVC and bamboo		B-56596
F	Wood, PVC and bamboo		B-57392
F	Green tree and wood.		B-57386
F	Green tree and wood.		B-62016
F	Green tree and wood.		B-56580
	Rough wood cutting	S1344D	P-05016
SPECIALIZED			
	Very Fast: Cuts wood, metal and nail embedded wood. M FORCE tooth blade 2 way cutting for extra speed.		P-45680
A	Very flexible blade for cast iron, steel pipe 3.5-5mm, non-ferrous metals, insulating materials, plastic, fibre glass.	S1222VF	P-04983
A	Metal cutting: steel, stainless steel, alloys, cast iron. Wood with nails, steel pipe 3-8 mm section.	S1022BF	P-04927
A	Metal cutting: steel, stainless steel, alloys, cast iron. Wood with nails. Steel and non-ferrous metals, steel pipe 1.5-3mm section.	S0122EF	P-04933
A	Nail embedded wood, non-ferrous, insulation. Plunge cutting especially in window frames.	S611DF	P-05088
C	Abrasive material, non-ferrous, aluminum, copper, brass, reinforced plastic, PVC and carbon.	S641HM	P-05044
A	Frozen material and butchery.		B-23248
A	Frozen material and butchery.		B-23254
	Aerated concrete and soft brick <215mm.	S1243TC	B-10394
	Medium size brick up to 315mm.	S1243TC	B-10403
	Insulation materials, glass wall and stone wall 10-175mm.	S1113AWP	B-52118
	Insulation materials, glass wall and stone wall 10-250mm.	S1213AWP	B-52124
	Insulation materials, glass wall and stone wall 10-300mm.	S2013AWP	B-52130
	Stainless steel sheet 1.5-4mm and fiberglass.	S1022EHM	B-51312
	Ideal for aerated concrete, concrete block, brick, low aggregate concrete, masonry, abrasive materials.	S1543HM	B-12809
RESCUE AND DEMOLITION			
	Fast Demolition and rescue: Cuts steel and nail embedded wood		P-47189
	Fast Demolition and rescue: Cuts steel and nail embedded wood	S1025VF	P-49529
	Fast Demolition and rescue: Cuts steel and nail embedded wood	S1118BF	P-47195
	Extra thick Demolisher Blade: Demolition in metal, pipe, channels, angle iron and nail embedded wood.		723076A3
	Wood with nails, metal, wood with steel elements, cast steel pipe, glass fibre reinforced plastic, epoxy. Long Life.	S967XHM	B-67206
	Wood with nails, metal, wood with steel elements, cast steel pipe, glass fibre reinforced plastic, epoxy. Long Life.	S116XHM	B-67212
SUPER EXPRESS			
A	Wood: Construction Timber, Ply wood, MDF, plastic, Super Express blade progressive teeth, especially suited for cordless machines	S2345X	B-05153
A	Metal: Thick and Thin Profiles and plate, Super Express blade progressive teeth, especially suited for cordless machines	S123XF	B-05038
A	Universal: Wood with nails, Metal Plates, Aluminium, plastic, Super Express Blade progressive teeth, suited to cordless machines	S3456XF	B-05044
A	Universal: Wood with nails, Aerated concrete, plastic, GRP suited to cordless machines, long and flexible for cutting tight to surfaces.	S1411VF	B-10637
	Pack of 3 Super Express blades: B-05153, B-05038, B-05044		B-13677

RECIPROCATING SAW BLADES

RECIPROCATING BLADES



Part No.	Quantity	Length	Plywood	Plastics	Aluminium	Stainless	Mild Steel	Teeth Per Inch	Blade Material
METAL BASIC									
B-16841	5	152					3-8	14	Bi-metal
B-16776	5	228					3-8	14	Bi-metal
B-05169	5	152					1.5-4	18	Bi-metal
B-16782	5	228					1.5-4	18	Bi-metal
B-16835	5	152					0.7-3	24	Bi-metal
B-43169	5	225					0.7-3	24	Bi-metal
P-04949	5	200						24	Bi-metal
METAL HEAVY DUTY									
B-43131	5	152					3-8	14-18	Bi-metal
B-43175	5	225					3-8	14-18	Bi-metal
B-43206	5	305					3-8	14-18	Bi-metal
B-43147	5	152					4-12	8-10	Bi-metal
B-43181	5	225					4-12	8-10	Bi-metal
B-43212	5	305					4-12	8-10	Bi-metal
B-43153	5	152					2-10	10-14	Bi-metal
B-43197	5	225					2-10	10-14	Bi-metal
B-43228	5	305					2-10	10-14	Bi-metal
B-55572	1	150					4-12	8	TC-HM
B-55588	1	225					4-12	8	TC-HM
B-55594	1	305					4-12	8	TC-HM
WOOD / METAL HEAVY DUTY									
B-43234	5	152	10-100					5-8	Bi-metal
B-43256	5	225	10-175					5-8	Bi-metal
B-43278	5	305	10-235					5-8	Bi-metal
B-49834	1	152	10-100					6-8	TC-HM
B-49840	1	228	10-175					6-8	TC-HM
B-49856	1	305	10-250					6-8	TC-HM
WOOD / METAL FLEXIBLE									
B-31843	5	152	5-100					10	Bi-metal
B-31859	5	225	5-175					10	Bi-metal
B-43240	5	152	5-100	3-100	3-10			10-14	Bi-metal
B-43262	5	225	5-175	3-175	3-10			10-14	Bi-metal
B-16857	5	305		5-20	5-20		5-200	10-14	Bi-metal
RECIPROCATING BLADES FOR JR100 / JR102 / DJR183 / DJR185									
B-20395	5	100mm						24	Bi-metal
B-20404	5	100mm						18	Bi-metal
B-20410	5	100mm						14	Bi-metal
B-20426	5	100mm						10	Bi-metal
B-20432	5	100mm						6	Bi-metal
B-20448	5	100mm						6	Bi-metal
B-20454	5	100mm						14-18	Bi-metal
B-55566	1	100mm					4-12	8	TC-HM

BLADE SET 6PC

B-44432

Wood Blades
152 - 203mm
2x B-05153
2x B-16798
2x B-05175



Master Carton: 10

BLADE SET 6PC

D-53051

Wood Blades
150mm
2x D-53089
2x D-51627
2x D-51633



Master Carton: 8

BLADE SET 6PC

B-44448

Metal Blades
152 - 228mm
2x B-05044
2x B-16776
2x B-16782



Master Carton: 10

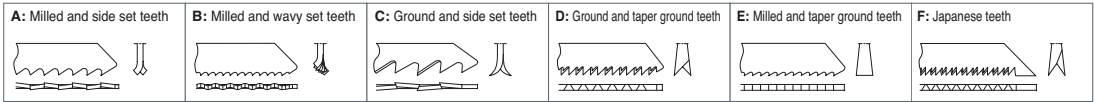

Teeth Type	Details	Bosch Equiv.	Part No.
METAL BASIC			
A	metal plate 3-8mm, pipe 10-100mm	S922BF	B-16841
A	metal plate 3-8mm, pipe 10-175mm	S1122BF	B-16776
A	metal plate 1.5-4mm, pipe 5-100mm	S922EF	B-05169
A	metal plate 1.5-4mm, pipe 5-175mm	S1122EF	B-16782
A	metal plate 0.7-3mm, pipe 5-100mm	S922AF	B-16835
A	metal plate 0.7-3mm, pipe 5-175mm	S1122AF	B-43169
A	stainless steel and iron	S1122AF	P-04949
METAL HEAVY DUTY			
A	metal plate 3-8mm, pipe <100mm	S926BEF	B-43131
A	metal plate 3-8mm, pipe <175mm	S1126BEF	B-43175
A	metal plate 3-8mm, pipe <250mm	S1226BEF	B-43206
A	thick sheet metal 4-12mm, pipe <100mm (fast cut)	S926CHF	B-43147
A	thick sheet metal 4-12mm, pipe <175mm (fast cut)	S1126CHF	B-43181
A	thick sheet metal 4-12mm, pipe <250mm (fast cut)	S1226CHF	B-43212
A	thick sheet metal 2-10mm, pipe <100mm (fine cut)	S925VF	B-43153
A	thick sheet metal 2-10mm, pipe <175mm (fine cut)	S1125VF	B-43197
A	thick sheet metal 2-10mm, metal pipe <250mm (fine cut)	S1225VF	B-43228
B	thick sheet metal 4-12mm, metal pipe <150mm, stainless steel and cast iron.	S955CHM	B-55572
B	thick sheet metal 4-12mm, metal pipe <175mm, stainless steel and cast iron.	S1155CHM	B-55588
B	thick sheet metal 4-12mm, metal pipe <250mm, stainless steel and cast iron.	S1255CHM	B-55594
WOOD / METAL HEAVY DUTY			
A	wood with metal, chipboard 10-100mm	S610VF	B-43234
A	wood with metal, chipboard 10-175mm	S1110VF	B-43256
A	wood with metal, chipboard 10-235mm	S1210VF	B-43278
A	wood with metal, chipboard, plastic, fibre-glass 10-100mm	S956XHM	B-49834
A	wood with metal, chipboard, plastic, fibre-glass 10-175mm	S1156XHM	B-49840
A	wood with metal, chipboard, plastic, fibre-glass 10-250mm	S1256XHM	B-49856
WOOD / METAL FLEXIBLE			
A	wood with metal 5-100mm, sheet metal	S922HF	B-31843
A	wood with metal 5-175mm, sheet metal	S1122HF	B-31859
A	wood with metal 5-100mm, aluminum 3-10mm, plastic 3-100mm	S922VF	B-43240
A	wood with metal 5-175mm, aluminum 3-10mm, plastic 3-175mm	S1122VF	B-43262
A	metal tubing 5-200mm, Aluminum & plastic 5-20mm	S1222VF	B-16857
RECIPROCATING BLADES FOR JR100 / JR102 / DJR183 / DJR185			
B	Thin metal 0.1-3mm		B-20395
B	Sheet metal 1.5-4mm		B-20404
B	Thick metal 3-8mm		B-20410
A	Wood/metal 3-12mm	S522HF	B-20426
A	Wood with nails 10-15mm		B-20432
A	Plasterboards 5-50mm	S528DF	B-20448
A	Wood/metal/plastics	S522BEF	B-20454
B	thick sheet metal 4-12mm, metal pipe <50mm, stainless steel, cast iron	S555CHM	B-55566

BLADE SET 10PC B-55572-10

B-55572 x 10



BLADE SET 10PC B-55588-10

B-55588 x 10



BLADE SET 10PC B-55594-10

B-55594 x 10



Batteries & Cases
Tool Holders
Drilling
Fixing
Saw Blades
Jigsaw & Recip
Multi Tool
Diamond
Bonded Abrasives
Flap Discs
Coated Abrasives
Router Cutters
Dust Extraction
Ground Maintenance

JIGSAW / JOINT CUTTER: ACCESSORIES

Part No.	Type	Model	Diameter
ANTI SPLINTERING DEVICE *****			
192557-6	Anti Splintering Device	4340, 4350, BJV140	
		DJV180, 4329, JV0600K	
415524-7	Anti Splintering Device	4304, 4305, 4304T	



BASE PLATES *****			
*413068-1	Plate	4304, 4305, 4304T	
*417852-6	Plate	4340, 4350, DJV180	
*Spare part cover			



PROTECTOR *****			
*415887-1	Protector	4304, 4305, 4304T, 4331, 4340	
*Spare part cover			



DUST NOZZLE *****			
192547-9	Dust nozzle	4304, 4305, 4306	
417853-4	Dust nozzle	4340, 4350	



Part No.	Details
JOINT CUTTER HCS BLADES (DSD180) *****	
B-49703	Plasterboard 55mm x 18mm x 0.55mm (x2)
B-49719	Wood 55mm x 18mm x 0.55mm (x2)



CHAIN MORTISER / BANDSAW: ACCESSORIES

Part No.	Type	Model	Diameter
----------	------	-------	----------

CHAIN MORTISER



A-16564	Chain	7104L	15
A-16570	Chain	7104L	16.5
A-16586	Chain	7104L	18
A-16592	Chain	7104L	21
A-16601	Chain	7104L	24
182229-1	Chain oil	7104L	100
133571-3	Chain bar assembly	7104L	15-24
221501-7	Sprocket	7104L	15-24

BAND SAW ACCESSORIES



196326-7*	Stand	2107FK / DPB180	
194026-3	Stand (W/O Covers)	DPB180	
196325-9	Wheel cover set	2107FK / DPB180	
	Includes saw guard		
191897-9	Wax for band saw		

*Machine not included, includes cover set

BANDSAW BLADES



Part No.	Blade Type	Material Gauge	TPI	Speed	Size	Material	Model	Pack
PORTABLE BAND SAW								
792567-9	Carbon	> 5mm	6	H	1140x13x0.5	Wood	DPB180, 2107FK	3
792560-3	Carbon	> 5mm	14	H	1140x13x0.5	Plastic, non ferrous metal Mild/cast steel, cast iron	DPB180, 2107FK	3
792559-8	Carbon	4-5mm	18	H	1140x13x0.5	Plastic, non ferrous metal Mild/cast steel, cast iron	DPB180, 2107FK	3
792558-0	Carbon	< 4mm	24	H	1140x13x0.5	Plastic, non ferrous metal Mild/cast steel, cast iron	DPB180, 2107FK	3
792557-2	BiM	> 5mm	14	H	1140x13x0.5	Plastic, non ferrous metal Mild/cast steel, cast iron	DPB180, 2107FK	1
792556-4	BiM	4-5mm	18	H	1140x13x0.5	Hard steel, stainless steel Plastic, non ferrous metal Mild/cast steel, cast iron	DPB180, 2107FK	1
194692-6	BiM	< 4mm	24	H	1140x13x0.5	Hard steel, stainless steel Plastic, non ferrous metal Mild/cast steel, cast iron	DPB180, 2107FK	1
B-40543	BiM	4-6mm	14	H	835x13x0.5	Hard steel, stainless steel Mild/cast steel, cast iron	DPB181	5
B-40559	BiM	2-3mm	18	H	835x13x0.5	Hard steel, stainless steel Mild/cast steel, cast iron Hard steel, stainless steel	DPB181	5
STATIONARY BAND SAW								
B-16667	High carbon steel	165mm	4	H	2240x16mm	Wood/ Cross cut	LB1200F	3
B-16673	High carbon steel	165mm	4	H	2240x13mm	Wood/ Universal	LB1200F	3
B-16689	High carbon steel	165mm	6	H	2240x6mm	Wood/ Curve cut	LB1200F	3
B-16695	High carbon steel	165mm	14	L	2240x16mm	Nonferrous metal / Cu / Ni / Ms / Zn	LB1200F	3

Batteries & Cases
Tool Holders
Drilling
Fixing
Saw Blades
Jigsaw & Recip
Multi Tool
Diamond
Bonded Abrasives
Flap Discs
Coated Abrasives
Router Cutters
Dust Extraction
Ground Maintenance

Multi Tool

Makita has developed a range of professional quality tools for oscillating multi tool machines, cutting and sawing blades for working in wood, metals, plastics and construction materials. Whether it's a renovation project or installation work, the high quality cutting blades will give you a perfect finish.

Choose from cutting, sawing, plunge cutting, rasping, and sanding with specialist attachments for an endless list of tasks.

The STARLOCK blade mounting system for oscillating tools allows you to change your multi tool accessory in just under three seconds.



Wood
Metal

Wood and Metal
Multi Material
Grout Abrasives

Cutting (plunge cutting)

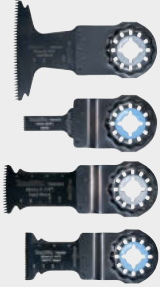

Applications:
Cutting of various materials such as oak wood, drywalls, plastics, copper pipes, non-hardened nails.

Benefits:

- Different from jigsaws, able to make a plunge cut in the wall for electrical connection box, lighting, exhaust fan, etc.
- The blade can be positioned in twelve different angles to allow easy operation in tight spaces.

Sawing



Applications:
Cutting of various materials such as oak wood, drywalls, plastics, copper pipes, non-hardened nails.

Benefits:

- Able to perform long distance push cut.
- Segmented shape of the blade allows for flush cutting.

Sanding



Applications:
Sanding wood, stone and paint removal with a full range of abrasive papers.

Benefits:

- Triangle design allows for effortless sanding into tight corners or difficult spaces
- Quick hook and loop fastening.
- Polishing pads also available.
- Connectable to vacuum cleaner with optional dust extraction system.

Removing Grout and Cutting Tiles

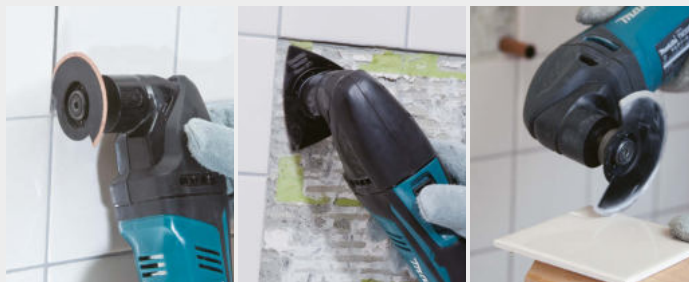
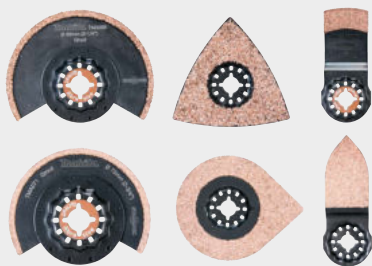

Applications:
Replacing broken wall or floor tiles, grout and adhesive removal.

Benefits:

- Less amount of dust scattering thanks to oscillating action.
- The segmented shape allows for flush cutting into corners.

Scraping



Applications:
Removing tough sealants, adhesives and paint products.

Benefits:

- Low-profile blade with a narrow tip allows easy removal of caulking, window putty, etc.
- Flexible design for scraping tasks.

MULTI TOOL: ACCESSORIES

STARLOCK SETS



Part No.	Details
----------	---------



TMA058
TMA065
TMA069
TMA078

TILE SET - 4PC PACK

B-67496 B-64923 / B-64989 / B-65028 / B-65115



TMA045
TMA048
TMA051
TMA066

FLOOR SET - 4PC PACK

B-67505 B-64799 / B-64820 / B-64858 / 64995



TMA045
TMA047
TMA053
TMA058

PLUNGE CUT SET - 4PC PACK

B-67480 B-64799 / B-64814 / B-64870 / B-64923



TMA045
TMA047
TMA053
TMA058

CARPENTRY SET - 5PC PACK

B-67511 B-64799 / B-64814 / B-64870 / B-65115 x2

STARLOCK SAWING



Part No.	Diameter	Material	TPI	Details
----------	----------	----------	-----	---------



TMA049

B-64836 85mm HCS 18 Wood



TMA046

B-64808 100mm BiM 15 Wood, Metal



TMA045

B-64799 85mm BiM 18 Wood, Metal



TMA064

B-64973 85mm BiM-TiN 18 Multi

STARLOCK SCRAPER



Part No.	Diameter	Material	Details
----------	----------	----------	---------



TMA065

B-64989 52mm HCS (Ridged) Mortar, Tile Adhesive



TMA066

B-64995 52mm HCS (Flexible) Mortar, Tile Adhesive

STARLOCK JOINT CUTTER



Part No.	Diameter	Material	Details
----------	----------	----------	---------



TMA067

B-65006 28x40mm HCS Insulation, Polystyrene, Rubber
B-65006-5 28x40mm HCS (5 Pack)



TMA082

B-69783 HCS Plung Cut for Sealent

STARLOCK CUTTING



Part No.	Diameter	Material	Details
----------	----------	----------	---------



TMA068

B-65012 11x24mm HCS Multi Purpose Blade



TMA063

B-64967 100mm BiM Segmented Knife Blade

STARLOCK RIFF SEGMENT SAW



Part No.	Diameter	Material	Grit	Details
----------	----------	----------	------	---------



TMA069

B-65028 85mm HM/RIFF 30 Mortar, Tile Adhesive, Fibreglass



TMA070

B-65034 85mm DIA 40 Soft Tile / FRP



TMA071

B-65040 70mm HM/RIFF 50 Mortar, Tile Adhesive, Fibreglass



TMA072

B-65056 85mm HM/RIFF 40 Mortar, Tile Adhesive, Fibreglass



TMA075

B-65084 32x30mm HM/RIFF 50 Mortar, Tile Adhesive, Fibreglass



TMA076

B-65090 32x50mm HM/RIFF 40 Mortar, Tile Adhesive, Fibreglass



TMA077





B-65109 32x50mm HM/RIFF 100 Mortar, Tile Adhesive, Fibreglass

Batteries & Cases
Tool Holders
Drilling
Fixing
Saw Blades
Jigsaw & Recip
Multi Tool
Diamond
Bonded Abrasives
Flap Discs
Coated Abrasives
Router Cutters
Dust Extraction
Ground Maintenance

MULTI TOOL: ACCESSORIES

STARLOCK RIFF SANDING



Part No.	Diameter	Material	Grit	Details
				TMA073
B-65062	78mm	HM/RIFF	20	Mortar, Tile Adhesive, Fibreglass
				TMA083
B-69799		HM/RIFF	20	Mortar, Tile Adhesive, Fibreglass
				TMA084
B-69808		HM/RIFF	40	Mortar, Tile Adhesive, Fibreglass
				TMA085
B-69814		HM/RIFF	60	Mortar, Tile Adhesive, Fibreglass
				TMA086
B-69820		HM/RIFF	100	Mortar, Tile Adhesive, Fibreglass

STARLOCK ROUTING AND RASPING



Part No.	Diameter	Material	Details
			TMA074
B-65078	70mm	HM/RIFF	40 Mortar, Tile Adhesive, Fibreglass



DUST EXTRACTION MULTI TOOL



Part No.	Details
	TMA079
196022-7	Dust Attachment Set TM3000C
199627-2	Dust Attachment Set DTM41 / DTM51



STARLOCK PLUNGE-CUTTING









Part No.	Diameter	Material	TPI	Details
				TMA079
B-69755	45mm	TC/HM	23	Metal
				TMA080
B-69761	32mm	TC/HM	20	Multi Material
				TMA081
B-69777	53mm	BIM	14	Drywall

STARLOCK PLUNGE-CUTTING

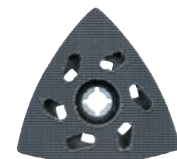

Part No.	Diameter	Material	TPI	Details
				TMA059
B-64939	32x50mm	BIM	20	Metal
B-64939-5	32x50mm	BIM	20	(5 Pack)
				TMA058
B-64923	20x30mm	BIM	20	Metal
B-64923-5	20x30mm	BIM	20	(5 Pack)
				TMA057
B-64917	10x30mm	BIM	20	Metal
				TMA061
B-64951	32x40mm	TC/HM	23	Metal
B-64951-5	32x40mm	TC/HM	23	(5 Pack)
				TMA060
B-64945	20x40mm	TC/HM	23	Metal
B-64945-5	20x40mm	TC/HM	23	(5 Pack)
				TMA055
B-64892	65x40mm	BIM	14	Wood
B-64892-5	65x40mm	BIM	14	(5 Pack)
				TMA052
B-64864	65x40mm	HCS	20	Wood
B-64864-5	65x40mm	HCS	20	(5 Pack)
				TMA056
B-64901	65x40mm	HCS	14	Wood
B-64901-5	65x40mm	HCS	14	(5 Pack)
				TMA053
B-64870	32x50mm	BIM	14	Wood
B-64870-20	32x50mm	BIM	14	(20 Pack)
				TMA051
B-64858	32x50mm	HCS	18	Wood
B-64858-5	32x50mm	HCS	18	(5 Pack)
B-64858-20	32x50mm	HCS	18	(20 Pack)
				TMA050
B-64842	24x50mm	HCS	18	Wood
				TMA054
B-64886	32x50mm	HCS	14	Wood
B-64886-5	32x50mm	HCS	14	(5 Pack)
				TMA048
B-64820	65x40mm	BIM	20	Wood, Metal
B-64820-5	65x40mm	BIM	20	(5 Pack)
				TMA047
B-64814	32x50mm	BIM	20	Wood, Metal
B-64814-5	32x50mm	BIM	20	(5 Pack)
B-64814-20	32x50mm	BIM	20	(20 Pack)

	Part No.	Diameter	Grit	Details	Pack	
SANDING WOOD MULTI TOOL *****						
	LONG LIFE	B-21565	93mm	60	wood, hardwood, chipboard, construction boards, metal	10
		B-21571	93mm	80	wood, hardwood, chipboard, construction boards, metal	10
		B-21587	93mm	100	wood, hardwood, chipboard, construction boards, metal	10
		B-21593	93mm	120	wood, hardwood, chipboard, construction boards, metal	10
		B-21602	93mm	180	wood, hardwood, chipboard, construction boards, metal	10
		B-22931	93mm	240	wood, hardwood, chipboard, construction boards, metal	10
		B-21559	93mm		Mixed pack: 60, 80, 100, 120, 180	10
SANDING WOOD MULTI TOOL *****						
	B-21624	93mm	60	wood, wooden materials	10	
	B-21630	93mm	80	wood, wooden materials	10	
	B-22947	93mm	100	wood, wooden materials	10	
	B-21646	93mm	120	wood, wooden materials	10	
	B-22953	93mm	150	wood, wooden materials	10	
	B-21652	93mm	180	wood, wooden materials	10	
	B-21668	93mm	240	wood, wooden materials	10	
	B-21618	93mm		Mixed pack: 60, 80, 120, 180, 240	10	
	P-33255	94mm	40	wood, wooden materials	10	
	P-33261	94mm	60	wood, wooden materials	10	
	P-33277	94mm	80	wood, wooden materials	10	
	P-33283	94mm	100	wood, wooden materials	10	
	P-33299	94mm	120	wood, wooden materials	10	
	P-33308	94mm	150	wood, wooden materials	10	
	P-33314	94mm	180	wood, wooden materials	10	
	P-33320	94mm	240	wood, wooden materials	10	
P-33336	94mm	320	wood, wooden materials	10		
SANDING PAINT MULTI TOOL *****						
	B-21680	93mm	60	paint, varnish, plaster	10	
	B-21696	93mm	80	paint, varnish, plaster	10	
	B-21705	93mm	100	paint, varnish, plaster	10	
	B-22969	93mm	120	paint, varnish, plaster	10	
	B-21711	93mm	240	paint, varnish, plaster	10	
	B-21727	93mm	320	paint, varnish, plaster	10	
	B-21674	93mm		Mixed pack: 60, 80, 100, 240, 320	10	
	P-42684	94mm	40	wood, wooden materials	10	
	P-42690	94mm	60	wood, wooden materials	10	
	P-42709	94mm	80	wood, wooden materials	10	
	P-42715	94mm	100	wood, wooden materials	10	
	P-42721	94mm	120	wood, wooden materials	10	
	P-42737	94mm	150	wood, wooden materials	10	
	P-42743	94mm	180	wood, wooden materials	10	
	P-42759	94mm	240	wood, wooden materials	10	
	P-42765	94mm	320	wood, wooden materials	10	
SANDING STONE MULTI TOOL *****						
	B-21749	93mm	120	gloss for stone and glass	10	
	B-21755	93mm	240	gloss for stone and glass	10	
	B-21761	93mm	400	gloss for stone and glass	10	
	B-21777	93mm	600	gloss for stone and glass	10	
	B-21783	93mm	1200	gloss for stone and glass	10	
	B-21733	93mm		Mixed pack: 120, 240, 400, 600, 1200	10	
	SANDING FLEECE MULTI TOOL *****					
	B-21799	93mm	100	cleaning fleece	1	
	B-21808	93mm	280	cleaning fleece	1	
	B-21814	93mm	-	cleaning fleece (no abrasive)	1	
POLISHING FELT MULTI TOOL *****						
	B-21820	93mm	Hard	pre-polishing surfaces	1	
BACKING PAD MULTI TOOL *****						
	B-65115			Sanding pads	1	

TMA078

Batteries & Cases
Tool Holders
Drilling
Fixing
Saw Blades
Jigsaw & Recip
Multi Tool
Diamond
Bonded Abrasives
Flap Discs
Coated Abrasives
Router Cutters
Dust Extraction
Ground Maintenance

COSMOS

S Y S T E M



nebula



comet



quasar

COSMOS RANGE

Powerful diamond blades for every work.

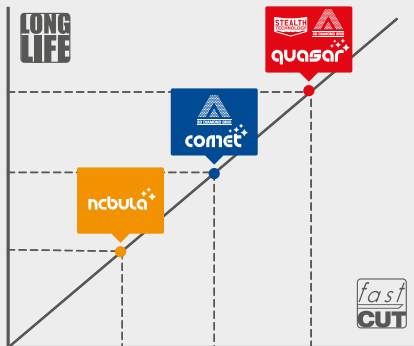

STEALTH TECHNOLOGY

For lower vibrations and noise reduction.



Advanced technology utilising laminate blades which reduce resonance and run significantly quieter than traditional blades.

3DDG TECHNOLOGY

For faster cutting and longer tool life.

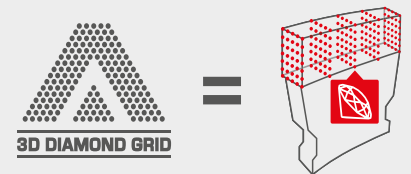

Allows each diamond grit to be placed in an even 3 dimensional pattern for unparalleled performance against traditional random distribution segments.

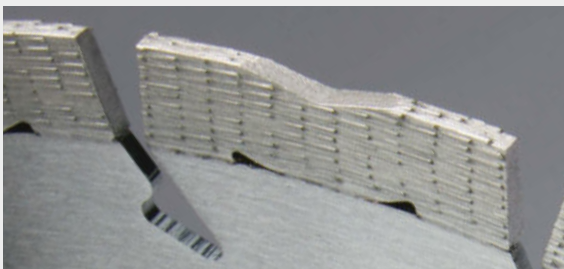

Segment Design: Makita introduces segment designs that are preformed, cold pressed then cured with immense pressure and blistering high temperatures. Each segment is scrutinised by quality control to exacting standards before being laser welded to the blank ensuring constant, reliable performance when used with or without water cooling. Quasar Segments have a fully usable 12mm 'M' shape segment and Comet a 10mm stepped segment. The unique segment designs are engineered to improved acceleration into cuts during the initial stage, reduce friction and significantly improve cooling.



Cooling Holes: Keeping a diamond blade cool during operation will help prevent expansion of the blade blank and ensure a smooth cutting action – reducing fatigue for the operator and potential damage to the power tool. The presence of holes in the blade also improves visibility for the user when cutting.

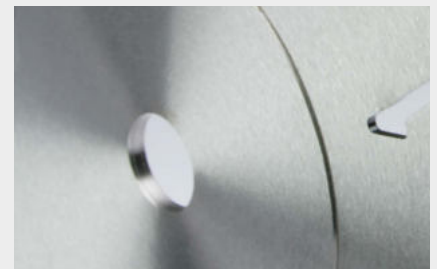

Fixed Metal Boss: The reinforced centre boss uses a soft metal inner core to dampen vibration through the blade, lowering running noise and guaranteeing an unrivalled quality and ease of cut for the operator. A stable blade cuts cleaner and quicker removing less material and extending blade life-time.

DIAMOND: COSMOS BLADES

	Suited	Applicable	Occasional	Ceramic tiles	Porcelain tiles	Marble	Hard Bricks	Flagstone	Granite	Terrazzo	Hard limestone	Clay	Slate	Concrete	Reinforced concrete	Bricks	Limestone	Fine grained sandstone	Green concrete	Abrasive sandstone	Asphalt	Fibreboard	Glassfibre	PVC	Steel	Joint Cut
QUOCER	3DDG	[Icons of various blade segments]																								
COMET	Tuck Point	[Icons of various blade segments]																								
	Asphalt	[Icons of various blade segments]																								
	Electroplated	[Icons of various blade segments]																								
	Continuous Rim	[Icons of various blade segments]																								
	Turbo Rim	[Icons of various blade segments]																								
	3DDG	[Icons of various blade segments]																								
NEBULA	Laser Welded	[Icons of various blade segments]																								



NEBULA



Laser welded segmented blade.

General purpose blade for use on construction materials. Suitable for masonry materials. Ideal for use on hard concrete and flint aggregate. Can be used either wet or dry. Suitable for petrol disc cutters.

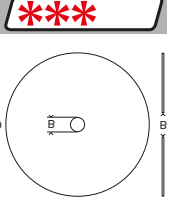

Segmented rim for cutting

Concrete, Soft brick, Soft slate, Concrete tiles

D mm	Part No.	Blade ID	Segment Height	B mm	Ring mm	Features
115mm	B-53986	(IRE)	10mm	22.23		Segmented, Laser welded
125mm	B-53992		10mm	22.23		Segmented, Laser welded
230mm	B-54025		10mm	22.23		Segmented, Laser welded
300mm	B-54031		10mm	20		Segmented, Laser welded
300mm	B-54047		10mm	20		Segmented, Laser welded
350mm	B-54053		10mm	25.4		Segmented, Laser welded
400mm	B-54069		10mm	25.4		Segmented, Laser welded
450mm	B-54075		10mm	25.4		Segmented, Laser welded

COMET



Premium universal 3D Grid diamond blade for professional performance.*

The Comet offers a wide range of products for specialist. A universal blade enhanced with the new 3DDG segments, turbo rim blade, continuous rim blade, electroplated blade, asphalt blade and tuck point blade.

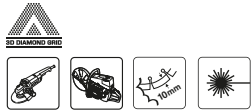
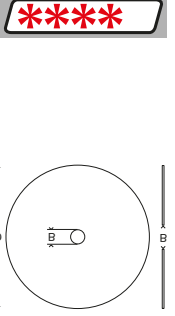

Segmented rim for fast cutting

Concrete, Mid/Hard brick, Terrazzo, Clay Tiles, Slate, Clay pipe

D mm	Part No.	Blade ID	Segment Height	B mm	Ring mm	Features
115mm	B-12762	CDS11522rC	10mm	22.23		Rapide, cooling holes
125mm	B-12778	CDS12522rC	10mm	22.23	20	Rapide, cooling holes
230mm	B-12784	CDS23022rCX	10mm	22.23		3DDG, Rapide, cooling holes
300mm	B-13546	CDS30020rCX	10mm	20		3DDG, Rapide, cooling holes
350mm	B-13552	CDS35025rCX	10mm	25.4	20	3DDG, Rapide, cooling holes
400mm	B-13568	CDS40025rCX	10mm	25.4	20	3DDG, Rapide, cooling holes

DIAMOND: COSMOS BLADES



Turbo rim for cutting

Hard brick, Granite, Limestone, Clay pipe, Slate, Terrazzo

D mm	Part No.	Blade ID	Segment Height	B mm	Ring mm	Features
100mm	B-12974	CDT10016	7mm	16		Turbo rim, std core
115mm	B-12980	CDT11522	7mm	22.23		Turbo rim, std core
125mm	B-12996	CDT12522	7mm	22.23	20	Turbo rim, std core
150mm	B-13007	CDT15022	7mm	22.23	20	Turbo rim, std core
175mm	B-13013	CDT17522	7mm	22.23		Turbo rim, std core
200mm	B-13029	CDT20030	7mm	30	25.4	Turbo rim, std core
230mm	B-13035	CDT23022	8mm	22.23		Turbo rim, std core
300mm	B-13041	CDT30025	8.5mm	25.4		Turbo rim, std core
350mm	B-13057	CDT35025	8.5mm	25.4		Turbo rim, std core

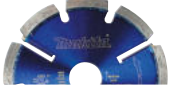

Tuck Point blade for mortar chasing

Mortar, Soft brick

D mm	Part No.	Blade ID	Segment Height	B mm	Ring mm	Features
100mm	B-13231	CDM10016	6.5mm	22.23		Tuck point, std core 6.5mm x 6.4mm
115mm	B-13247	CDM11522	6.5mm	22.23		Tuck point, std core 6.5mm x 6.4mm
125mm	B-13253	CDM12522	6.5mm	22.23		Tuck point, std core 6.5mm x 6.4mm



Continuous rim for cutting

Ceramic tiles, Porcelain

D mm	Part No.	Blade ID	Segment Height	B mm	Ring mm	Features
80mm	B-13063	CDC8015	5mm	15		Continuous rim, std core
100mm	B-13079	CDC10016	5mm	16		Continuous rim, std core
115mm	B-13085	CDC11522	5mm	22.23		Continuous rim, std core
125mm	B-13091	CDC12522	5mm	22.23	20	Continuous rim, std core
150mm	B-13100	CDC15022	5mm	22.23	20	Continuous rim, std core
175mm	B-13116	CDC17522	5mm	22.23		Continuous rim, std core
200mm	B-13122	CDC20030	5mm	30	25.4	Continuous rim, std core
230mm	B-13138	CDC23030	5mm	30	25.4	Continuous rim, std core
300mm	B-13144	CDC30025	7mm	25.4		Continuous rim, std core
350mm	B-13150	CDC35030	7mm	30	25.4	Continuous rim, std core



Electro plated rim for cutting

Marble, Glass fibre, Fibreboard, GRP

D mm	Part No.	Blade ID	Segment Height	B mm	Ring mm	Features
100mm	B-13166	CDE10016	-	16		Electro plated, std core
115mm	B-13172	CDE11522	-	22.23		Electro plated, std core
125mm	B-13188	CDE12522	-	22.23	20	Electro plated, std core
150mm	B-13194	CDE15022	-	22.23	20	Electro plated, std core
175mm	B-13203	CDE17522	-	22.23		Electro plated, std core
230mm	B-13219	CDE23022	-	22.23		Electro plated, std core
250mm	B-13225	CDE25022	-	22.23		Electro plated, std core



Segmented rim, asphalt blade for cutting

Asphalt, Abrasive limestone, Grit stone, Abrasive sandstone, Soft Block

D mm	Part No.	Blade ID	Segment Height	B mm	Ring mm	Features
300mm	B-13269	CDA30020	10mm	20		Asphalt, std core. 3D Diamond Grid
350mm	B-13275	CDA35025	10mm	25.4	20	Asphalt, std core. 3D Diamond Grid
400mm	B-42905	CDA40025	10mm	25.4	20	Asphalt, std core. 3D Diamond Grid

QUASAR



Premium universal application 3D Grid diamond blade for professional performance.

Enhanced with 3DDG segments, the new Quasar is a high end silent core product that reduces noise and vibrations.

Designed for large angle grinders and petrol cutters.

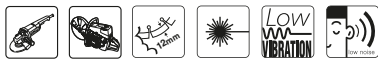
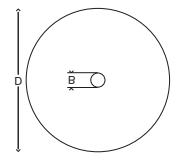

Segmented rim – quiet, long life blade – for cutting

Concrete, Mid/Hard brick, Terrazzo, Clay Tiles, Slate

D mm	Part No.	Blade ID	Segment Height	B mm	Ring mm	Features
230mm	B-12712	QDS23022XS	12mm	22.23		3DDG, Stealth
300mm	B-13459	QDS30020XS	12mm	20		3DDG, Stealth
350mm	B-13465	QDS35025XS	12mm	25.4	20	3DDG, Stealth
400mm	B-13471	QDS40025XS	12mm	25.4	20	3DDG, Stealth

DIAMAK



Entry level economical blades covering a wide range of building materials.

Available in segmented, turbo and continuous rim variants. Can be used either wet or dry.

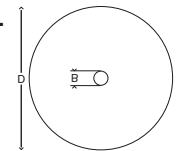

Segmented rim for cutting

Most Masonry Materials, Slabs, Bricks, Block Sandstone, Slate and Limestone.

D mm	Part No.	Blade ID	Segment Height	B mm	Ring mm	Features
115mm	D-61123	DDS115	7mm	22.23		Segmented rim, std core
125mm	D-61139	DDS125	7mm	22.23		Segmented rim, std core
230mm	D-61145	DDS230	7mm	22.23		Segmented rim, std core
300mm	P-83864		7mm	20		Segmented rim, std core



Turbo rim for cutting

For hard dense materials, Granite, Clay product, Slate, Limestone, Hard concrete.

D mm	Part No.	Blade ID	Segment Height	B mm	Ring mm	Features
115mm	D-61151	DDT115	7mm	22.23		Turbo rim, std core
125mm	D-61167	DDT125	7mm	22.23	20	Turbo rim, std core
230mm	D-61173	DDT230	7mm	22.23		Turbo rim, std core



Continuous rim for cutting

For tile cutting, Marble, Limestone, Porcelain, Terrazzo.

D mm	Part No.	Blade ID	Segment Height	B mm	Ring mm	Features
115mm	D-61189	DDC115	7mm	22.23		Continuous rim, std core
200mm	D-61195	DDC200	7mm	30	25.4	Continuous rim, std core
250mm	D-61204	DDC250	7mm	30	25.4	Continuous rim, std core

Batteries & Cases
Tool Holders
Drilling
Fixing
Saw Blades
Jigsaw & Recip
Multi Tool
Diamond
Bonded Abrasives
Flap Discs
Coated Abrasives
Router Cutters
Dust Extraction
Ground Maintenance

DIAMOND: BLADES, GRINDING HEADS

X-LOCK DIAMOND BLADES



Diamond blades for use with our cordless X-Lock angle grinders

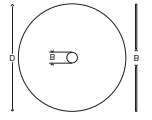

X-Lock Segmented for cutting
Concrete.

- Tool-less X-Lock Fitting system allows for safe and easy disc change.
- Improved safety and efficiency.

D mm	Part No.	Blade ID	Segment Height	B mm	Ring mm	Features
100mm	E-02054			22.23		Segmented
115mm	E-02060			22.23		Segmented
125mm	E-02076			22.23		Segmented

STANDARD DIAMOND BLADES

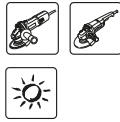

Standard Diamond Blades
Porcelain tile, ceramic tile.

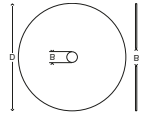

D mm	Part No.	Blade ID	Segment Height	B mm	Ring mm	Features
115mm	B-46327			22.23		Wave
125mm	B-46333			22.23		Wave
230mm	E-02967			22.23		Segmented

VACUUM BRAZED DIAMOND



The thin vacuum brazed diamond wheel gives you up to 57 times more cuts than a standard abrasive cut off wheel. Specifically designed for cutting steel materials, this blade will also cut PVC (pipe/board) and concrete.

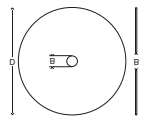

Continuous rim for cutting

Iron, stainless steel, nonferrous metal, PVC, FRP, mortar, concrete.

- Less sparks
- Reduced odour
- Steel body – to help prevent damage when dropped or knocked

D mm	Part No.	Blade ID	Segment Height	B mm	Ring mm	Features
115mm	B-53687			22.23		Segmented Rim
125mm	B-53693			22.23		Segmented Rim
180mm	B-53702			22.23		Segmented Rim
230mm	B-53718			22.23		Segmented Rim

TUNGSTEN CARBIDE BLADES



- Tungsten Carbide grit for high cutting velocity
- Laser welded for longer life
- For cutting PVC, plaster board, sanding board, fibre material
- Not for use with wood

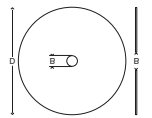

D mm	Part No.	Blade ID	Segment Height	B mm	Ring mm	Features
115	B-57716			22.23		
125	B-57722			22.23		

Part No.	D mm	H mm	Grit	Pack
----------	------	------	------	------























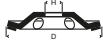



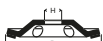



ANTI-VIBRATION DIAMOND HEAD



B-38560 125mm M14 1

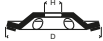

The Anti-Vibration Offset Diamond Wheel features 2 small shock absorbers within the flange system. These work to absorb vibration, limiting transferred vibration to machine and end user. The rubber rings also reduce tapping, allowing for smooth and efficient grinding. 40% increased grinding efficiency compared with a standard grinding wheel.



DIAMOND: GRINDING HEADS

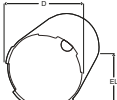

	Part No.	D mm	H mm	Grit	Pack
GJ2 SINGLE RIM *****					
 <p>Ideal for roughing gives fast stock removal. For use with PC1100.</p> 	A-86321	110	15		1
	 				
GD80 CONTINUOUS RIM *****					
 <p>The fine diamond grit is ideal for fine concrete planing. For use with PC1100.</p> 	792289-1	110	15		1
	 				
SBG4 SPIRAL RIM *****					
 <p>Suitable for grinding larger areas with 230mm angle grinder.</p> 	P-40652	180	22.23		1
	 				
SBG5 TWIN RIM *****					
 <p>Ideal general grinding head, twin row gives good stability and rapid removal. 110mm can be used on PC1100. For concrete and sandstone.</p> 	A-07369	110	22.23/15		1
	P-29119	180	22.23		1
	 				
SBGR4 RESIN SEGMENTED RIM *****					
 <p>Excellent tool for pre-cast concrete work. Resin infill ensures low chipping on edges. Suitable for most stone types.</p> 	P-40668	100	M14		1
	 				
SBG2 TURBO RIM *****					
 <p>Ideal for working on hard stone such as granite, marble and limestone. Can be used wet on stone polishing machines.</p> 	P-29050	100	M14		1
	P-40646	180	22.23		1
	 				
STONE POLISHER PW5000 DIAMOND PADS *****					
 <p>*265083-9 fixing screws for head cover (2 required)</p> 	D-15584			50	1
	D-15590			100	1
	D-15609			200	1
	D-15615			400	1
	D-15621			800	1
	D-15637			1500	1
	D-15643			3000	1
	D-15659			Finishing Buffer	1
	D-15805	50,100,200,400,800,1500,3000 + Buff		8pc Kit	8
	417322-5*			Head cover	1
PC5000C GRINDING HEADS *****					
 <p>Designed to work in conjunction with the PC5000C concrete planer, you can choose between a segmented head for coarse work or a continuous rim head for fine work.</p> 	B-12289	125	22	Fine	1
	B-12295	125	22	Coarse	1
	 				
				<p>Fine: A continuous grinding diamond disc ideal for finishing work. Coarse: A segmented grinding diamond disc ideal for rough work.</p>	
PCD OFFSET DIAMOND HEAD *****					
 <p>For removal of polyurethane, adhesive, paint, epoxy and acrylic coatings</p> 	B-53160			5 Tip	1
	B-53176			6 Tip	1

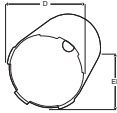

Batteries & Cases
Tool Holders
Drilling
Fixing
Saw Blades
Jigsaw & Recip
Multi Tool
Diamond
Bonded Abrasives
Flap Discs
Coated Abrasives
Router Cutters
Dust Extraction
Ground Maintenance



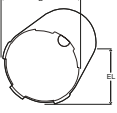

DIAMOND: CORES WET DRILLING

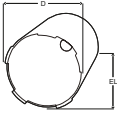

		Part No.	D mm	EL mm	Pack
DWS3CR *****					
 <p>Suitable for cutting: Granite, marble, limestone, slate, hard bricks and other dense and non-abrasive materials.</p>   	P-40733	12	400	1	
	P-40749	14	400	1	
	P-40755	16	400	1	
	P-40761	18	400	1	
	P-40777	20	400	1	
	P-40783	22	400	1	
	P-40799	24	400	1	
	P-40808	25	400	1	
	P-40814	28	400	1	
	P-40820	30	400	1	
	P-40836	32	400	1	

		Part No.	D mm	EL mm	Pack
DWC4CR *****					
 <p>Suitable for cutting: Concrete, reinforced concrete, sandstone, bricks.</p>   	P-40842	12	400	1	
	P-40858	14	400	1	
	P-40864	16	400	1	
	P-40870	18	400	1	
	P-40886	20	400	1	
	P-40892	22	400	1	
	P-40901	24	400	1	
	P-40917	25	400	1	
	P-40923	28	400	1	
	P-40939	30	400	1	
	P-40945	32	400	1	
	P-40973	36	400	1	
	P-40989	38	400	1	
	P-40995	40	400	1	
	P-41006	52	400	1	

		Part No.	D mm	EL mm	Pack
DWC4 *****					
 <p>Suitable for cutting: Hard concrete or use on low powered drilling machines.</p>   	P-41034	65	400	1	
	P-41056	78	400	1	
	P-41078	82	400	1	
	P-41090	92	400	1	
	P-41115	102	400	1	
	P-41137	107	400	1	
	P-41143	112	400	1	
	P-41159	117	400	1	
	P-41165	127	400	1	
	P-41171	152	400	1	
	P-41187	162	400	1	
	P-41193	178	400	1	
	P-41202	182	400	1	
	P-41218	202	400	1	
	P-41224	212	400	1	
	P-41230	225	400	1	
	P-41246	252	400	1	

		Part No.	D mm	EL mm	Pack
DWC7 *****					
 <p>Suitable for cutting: Concrete with medium to soft aggregates.</p>   	P-41305	52	400	1	
	P-41333	65	400	1	
	P-41355	78	400	1	
	P-41377	82	400	1	
	P-41399	92	400	1	
	P-41414	102	400	1	
	P-41436	107	400	1	
	P-41442	112	400	1	
	P-41458	117	400	1	
	P-41464	127	400	1	
	P-41470	152	400	1	
	P-41486	162	400	1	
	P-41492	178	400	1	
	P-41501	182	400	1	
	P-41517	202	400	1	
	P-41539	225	400	1	
	P-41545	252	400	1	

		Part No.	D mm	EL mm	Pack
SBD4 *****					
 <p>Ideal for dense hard concrete products with non-abrasive aggregate and drilling concrete with soft aggregate.</p> <p>Scotland and Ireland</p>   	P-70948	32	150	1	
	P-70954	38	150	1	
	P-70960	48	150	1	
	P-70976	52	150	1	
	P-70982	65	150	1	
	P-70998	78	150	1	
	P-71015	117	150	1	
	P-71021	127	150	1	
	P-71037	152	150	1	
	P-71043	162	150	1	

Part No.	D mm	EL mm	Pack																																																
DB6 DIAMAK *****																																																			
	Suitable for cutting: Granite, marble, limestone, slate, hard bricks and other dense and non-abrasive materials.	 	<table border="1"> <tr><td>P-64060</td><td>22</td><td>300</td><td>1</td></tr> <tr><td>P-64076</td><td>28</td><td>300</td><td>1</td></tr> <tr><td>P-64082</td><td>32</td><td>150</td><td>1</td></tr> <tr><td>P-64098</td><td>38</td><td>150</td><td>1</td></tr> <tr><td>P-64107</td><td>48</td><td>150</td><td>1</td></tr> <tr><td>P-64113</td><td>52</td><td>150</td><td>1</td></tr> <tr><td>P-64129</td><td>65</td><td>150</td><td>1</td></tr> <tr><td>P-64135</td><td>78</td><td>150</td><td>1</td></tr> <tr><td>P-64141</td><td>107</td><td>150</td><td>1</td></tr> <tr><td>P-64157</td><td>117</td><td>150</td><td>1</td></tr> <tr><td>P-64163</td><td>127</td><td>150</td><td>1</td></tr> <tr><td>P-64179</td><td>152</td><td>150</td><td>1</td></tr> </table>	P-64060	22	300	1	P-64076	28	300	1	P-64082	32	150	1	P-64098	38	150	1	P-64107	48	150	1	P-64113	52	150	1	P-64129	65	150	1	P-64135	78	150	1	P-64141	107	150	1	P-64157	117	150	1	P-64163	127	150	1	P-64179	152	150	1
P-64060	22	300	1																																																
P-64076	28	300	1																																																
P-64082	32	150	1																																																
P-64098	38	150	1																																																
P-64107	48	150	1																																																
P-64113	52	150	1																																																
P-64129	65	150	1																																																
P-64135	78	150	1																																																
P-64141	107	150	1																																																
P-64157	117	150	1																																																
P-64163	127	150	1																																																
P-64179	152	150	1																																																

DB6 DIAMAK 5PC SET		P-74712
1 x SDS+ adaptor	1 x 52x150mm	
1 x 13mm hex adaptor	1 x 65x150mm	
1 x Barrel extension	1 x 117x150mm	
1 x Drift key	1 x 127x150mm	
1 x 10mm pilot bit		
1 x 38x150mm		

SBD5		*****																																
	Suitable for cutting: Dense hard bricks such as engineering bricks and other dense non-abrasive materials.	<table border="1"> <tr><td>P-25775</td><td>22</td><td>300</td><td>1</td></tr> <tr><td>P-25781</td><td>28</td><td>300</td><td>1</td></tr> <tr><td>P-25812</td><td>52</td><td>150</td><td>1</td></tr> <tr><td>P-25410</td><td>65</td><td>150</td><td>1</td></tr> <tr><td>P-25454</td><td>117</td><td>150</td><td>1</td></tr> <tr><td>P-25476</td><td>127</td><td>150</td><td>1</td></tr> <tr><td>P-25460</td><td>152</td><td>150</td><td>1</td></tr> <tr><td>P-40696</td><td>162</td><td>150</td><td>1</td></tr> </table>	P-25775	22	300	1	P-25781	28	300	1	P-25812	52	150	1	P-25410	65	150	1	P-25454	117	150	1	P-25476	127	150	1	P-25460	152	150	1	P-40696	162	150	1
P-25775	22	300	1																															
P-25781	28	300	1																															
P-25812	52	150	1																															
P-25410	65	150	1																															
P-25454	117	150	1																															
P-25476	127	150	1																															
P-25460	152	150	1																															
P-40696	162	150	1																															

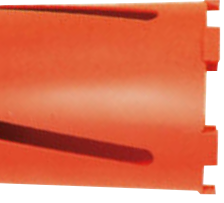
PRB7		*****																																																																																																												
	Suitable for cutting: Most types of brick and concrete blocks.	<table border="1"> <tr><th colspan="4">SLOTTED TUBE</th></tr> <tr><td>P-25535</td><td>22</td><td>300</td><td>1</td></tr> <tr><td>P-25541</td><td>28</td><td>300</td><td>1</td></tr> <tr><td>P-44731</td><td>32</td><td>150</td><td>1</td></tr> <tr><td>P-25557</td><td>38</td><td>150</td><td>1</td></tr> <tr><td>P-25563</td><td>48</td><td>150</td><td>1</td></tr> <tr><td>P-25585</td><td>65</td><td>150</td><td>1</td></tr> <tr><td>P-25591</td><td>78</td><td>150</td><td>1</td></tr> <tr><td>P-25600</td><td>91</td><td>150</td><td>1</td></tr> <tr><td>P-25616</td><td>107</td><td>150</td><td>1</td></tr> <tr><td>P-25622</td><td>117</td><td>150</td><td>1</td></tr> <tr><td>P-25638</td><td>127</td><td>150</td><td>1</td></tr> <tr><td>P-25644</td><td>152</td><td>150</td><td>1</td></tr> <tr><th colspan="4">SOLID TUBE FOR DUST EXTRACTION</th></tr> <tr><td>P-57102</td><td>22</td><td>300</td><td>1</td></tr> <tr><td>P-57118</td><td>28</td><td>300</td><td>1</td></tr> <tr><td>P-57124</td><td>32</td><td>150</td><td>1</td></tr> <tr><td>P-57146</td><td>38</td><td>150</td><td>1</td></tr> <tr><td>P-57152</td><td>48</td><td>150</td><td>1</td></tr> <tr><td>P-57174</td><td>65</td><td>150</td><td>1</td></tr> <tr><td>P-57180</td><td>78</td><td>150</td><td>1</td></tr> <tr><td>P-57196</td><td>91</td><td>150</td><td>1</td></tr> <tr><td>P-57205</td><td>107</td><td>150</td><td>1</td></tr> <tr><td>P-57211</td><td>117</td><td>150</td><td>1</td></tr> <tr><td>P-57227</td><td>127</td><td>150</td><td>1</td></tr> <tr><td>P-57233</td><td>152</td><td>150</td><td>1</td></tr> <tr><td>P-44753</td><td>162</td><td>150</td><td>1</td></tr> </table>	SLOTTED TUBE				P-25535	22	300	1	P-25541	28	300	1	P-44731	32	150	1	P-25557	38	150	1	P-25563	48	150	1	P-25585	65	150	1	P-25591	78	150	1	P-25600	91	150	1	P-25616	107	150	1	P-25622	117	150	1	P-25638	127	150	1	P-25644	152	150	1	SOLID TUBE FOR DUST EXTRACTION				P-57102	22	300	1	P-57118	28	300	1	P-57124	32	150	1	P-57146	38	150	1	P-57152	48	150	1	P-57174	65	150	1	P-57180	78	150	1	P-57196	91	150	1	P-57205	107	150	1	P-57211	117	150	1	P-57227	127	150	1	P-57233	152	150	1	P-44753	162	150	1
SLOTTED TUBE																																																																																																														
P-25535	22	300	1																																																																																																											
P-25541	28	300	1																																																																																																											
P-44731	32	150	1																																																																																																											
P-25557	38	150	1																																																																																																											
P-25563	48	150	1																																																																																																											
P-25585	65	150	1																																																																																																											
P-25591	78	150	1																																																																																																											
P-25600	91	150	1																																																																																																											
P-25616	107	150	1																																																																																																											
P-25622	117	150	1																																																																																																											
P-25638	127	150	1																																																																																																											
P-25644	152	150	1																																																																																																											
SOLID TUBE FOR DUST EXTRACTION																																																																																																														
P-57102	22	300	1																																																																																																											
P-57118	28	300	1																																																																																																											
P-57124	32	150	1																																																																																																											
P-57146	38	150	1																																																																																																											
P-57152	48	150	1																																																																																																											
P-57174	65	150	1																																																																																																											
P-57180	78	150	1																																																																																																											
P-57196	91	150	1																																																																																																											
P-57205	107	150	1																																																																																																											
P-57211	117	150	1																																																																																																											
P-57227	127	150	1																																																																																																											
P-57233	152	150	1																																																																																																											
P-44753	162	150	1																																																																																																											

PRB9		*****																																																				
	Suitable for cutting: Abrasive materials such as low density concrete blocks and abrasive sandstone. Also suitable for high powered machines.	<table border="1"> <tr><td>P-25650</td><td>22</td><td>300</td><td>1</td></tr> <tr><td>P-25666</td><td>28</td><td>300</td><td>1</td></tr> <tr><td>P-25672</td><td>38</td><td>150</td><td>1</td></tr> <tr><td>P-25688</td><td>48</td><td>150</td><td>1</td></tr> <tr><td>P-25694</td><td>52</td><td>150</td><td>1</td></tr> <tr><td>P-25703</td><td>65</td><td>150</td><td>1</td></tr> <tr><td>P-25719</td><td>78</td><td>150</td><td>1</td></tr> <tr><td>P-25727</td><td>91</td><td>150</td><td>1</td></tr> <tr><td>P-25731</td><td>107</td><td>150</td><td>1</td></tr> <tr><td>P-44747</td><td>117</td><td>150</td><td>1</td></tr> <tr><td>P-25753</td><td>127</td><td>150</td><td>1</td></tr> <tr><td>P-25769</td><td>152</td><td>150</td><td>1</td></tr> <tr><td>P-40727</td><td>162</td><td>150</td><td>1</td></tr> </table>	P-25650	22	300	1	P-25666	28	300	1	P-25672	38	150	1	P-25688	48	150	1	P-25694	52	150	1	P-25703	65	150	1	P-25719	78	150	1	P-25727	91	150	1	P-25731	107	150	1	P-44747	117	150	1	P-25753	127	150	1	P-25769	152	150	1	P-40727	162	150	1
P-25650	22	300	1																																																			
P-25666	28	300	1																																																			
P-25672	38	150	1																																																			
P-25688	48	150	1																																																			
P-25694	52	150	1																																																			
P-25703	65	150	1																																																			
P-25719	78	150	1																																																			
P-25727	91	150	1																																																			
P-25731	107	150	1																																																			
P-44747	117	150	1																																																			
P-25753	127	150	1																																																			
P-25769	152	150	1																																																			
P-40727	162	150	1																																																			

DIAMOND: CORES DRY DRILLING, ACCESSORIES

	Part No.	Details	Fitting	Pack
BARREL EXTENSION *****				
	P-41551	100mm length	1/2" BSP F-M	1
	P-57261	Barrel extension 150mm	1/2" BSP	1
	P-34718	300mm length	1/2" BSP F-M	1
	P-57255	Barrel extension 250mm	1/2" BSP	1

	Part No.	Details	Fitting	Pack
STEEL HEX EXTENSION BAR *****				
	P-41604	100mm length	1.25" UNC F-M	1
	P-41610	200mm length	1.25" UNC F-M	1
	P-41626	300mm length	1.25" UNC F-M	1
	P-41632	400mm length	1.25" UNC F-M	1
	P-41648	500mm length	1.25" UNC F-M	1

	Part No.	Details	Fitting	Pack
ANCHOR SYSTEMS *****				
	P-41713	Wing nut		1
	P-41735	Threaded rod 250mm OA		1
	P-41729	Threaded rod 200mm OA		1
	P-41741	Expanded hammer fitting		1

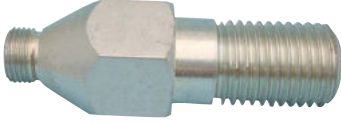
	Part No.	Details	Fitting	Pack
ADAPTORS *****				
	P-49292	DBM080 adaptor	R1/2" F - R1/2" M	1
	P-49286	DBM131 adaptor	R1/2" M - R1/2" M	1
	P-34562	13mm chuck adaptor	1/2" BSP Male	1
	P-30031	SDS chuck adaptor	1/2" BSP male	1
	P-25482	Adaptor pack 13mm		1
	P-34730	Adaptor pack SDS		1
	P-41589	SDS male to hex female		1
	P-41707	HI to 1/2" BSP F	HI	1
	P-41597	HI adaptor to 1/2" BSP male		1
	P-41698	1/2" BSP M to 1/2" BSP M	1/2" BSP M	1
	P-41676	1.25 UNC M to 1/2" BSP F	1.25" UNC F	1
	P-41682	1/2" BSP M to 1.25" UNC M	1/2" BSP M	1

	Part No.	Details	Fitting	Pack
DRIFT KEY *****				
	P-34752	Drift Key		1

	Part No.	Details	Fitting	Pack
PILOT DRILL *****				
	P-74706	TC Tip Pilot Drill	10mm x 225mm	1

	Part No.	Details	Fitting	Pack
GUIDES *****				
	P-34746	Guide rod		1
	P-49301	Spring point guide		1
	P-41567	Guide plug for 22mm drill		1
	P-41573	Guide plug for 28mm drill		1
	P-57277	Dust swivel centre guide		1

	Part No.	Details	Fitting	Pack
ADAPTORS *****				
	B-00751	K - Taper drill holder		1
	D-14093	SDS+ to rotary adaptor		1

Part No.	Details	Fitting	Pack
----------	---------	---------	------

DUST EXTRACTION



P-57249	Dust extraction swivel unit		1
---------	-----------------------------	--	---

Cannot be used if the pilot drill bit or guide bar are in place.

FLANGES FOR "BOLT ON" STYLE CORE BODIES



P-41654	3 hole flange	1.25" UNC	1
P-41660	6 hole flange	1.25" UNC	1

DIAMOND DRILL STAND



Excellent drill stand for wet core drilling. Clamped by 4 anchor bolts and very smooth core feed with rack pinion drive mechanism.



P-40082	Max drill diameter @ 90° 102mm Column height 680mm Mounting plate universal Collar diameter 53mm Max inclination 45° Weight 7.7kg		1
P-40098	Space saving anchor base 320x230mm Fastening set comp for P-40082		1

ACCESSORY APPLICATION GUIDE

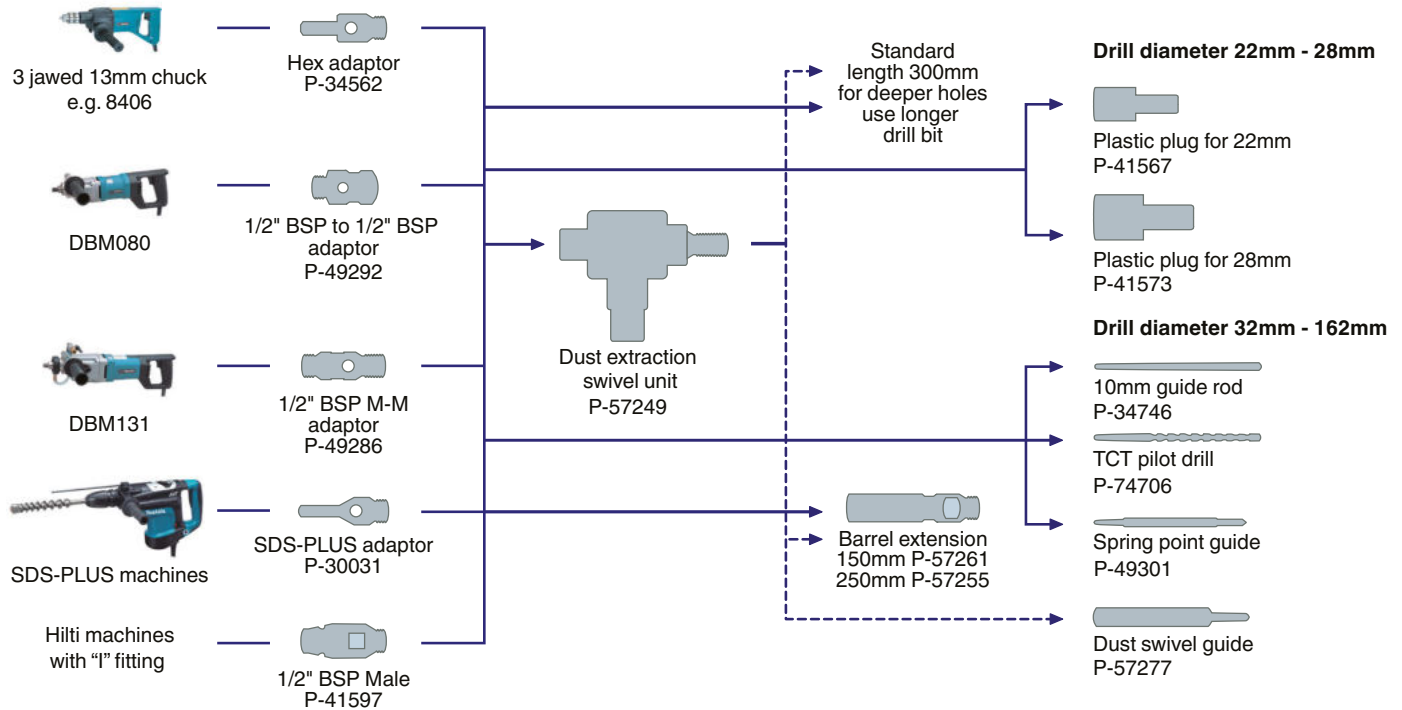

Batteries & Cases
Tool Holders
Drilling
Fixing
Saw Blades
Jigsaw & Recip
Multi Tool
Diamond
Bonded Abrasives
Flap Discs
Coated Abrasives
Router Cutters
Dust Extraction
Ground Maintenance

Bonded Abrasives

Cutting and grinding discs can be used on machines as diverse as angle grinders and petrol cutters to cut or grind metal or masonry, including concrete. A wide range of reinforced abrasives are available for most applications. Depending on the type of use, the right bonded abrasive disk should be chosen to allow a safe, efficient and high quality job to be completed.

2 in 1 Abrasive Wheel

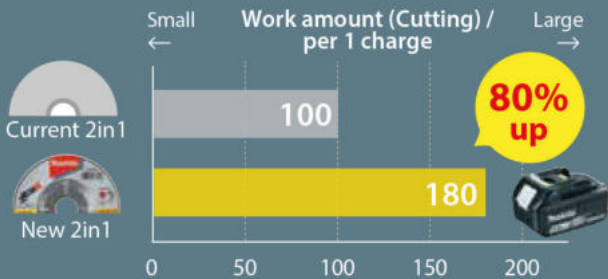

Note:
 1. The test results depend to a great extent on the hardness of materials, etc.
 2. The numbers in the bar graphs are relative values when the capacity of Makita Current 2in wheel (Thickness:3.2mm) is indexed at 100.

0.8mm Thin Slitting Disc

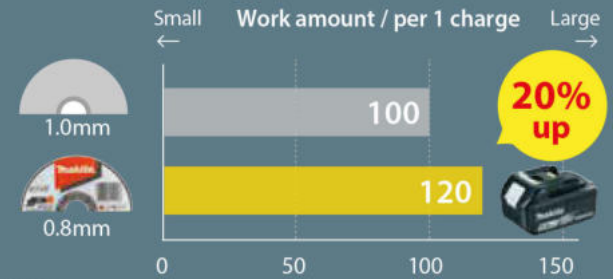
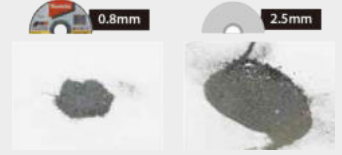
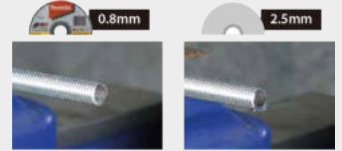

Note:
 1. The test results depend to a great extent on the hardness of materials, etc.
 2. The numbers in the bar graphs are relative values when the capacity of Makita Cut-off wheel (Thickness:1.0mm) is indexed at 100.

How to read the Makita bonded abrasive wheel identification code.



Grain Size
 10-24 = Coarse
 30-60 = Medium
 70-180 = Fine

Bond Type
 -BF = Reinforced Resin

A 3 6 P - B F

Abrasive Material Type
 A= Aluminium Oxide
 W= White Aluminium Oxide
 C= Silicon Carbide
 Z= Aluminium Zirconium
 SA= Single Crystal Aluminium Oxide

Hardness
 A = Softest
 Z = Hardest

EXAMPLES

SA46P: Single Crystal Aluminium Oxide, Medium Grain, Medium
C30T: Silicon Carbide, Medium Grain, Hard
C24R-BF: Silicon Carbide, Coarse, Hard, Reinforced Resin

BONDED ABRASIVES

Part No.	D mm	T mm	B mm	ID Code	Master Carton	Pack
----------	------	------	------	---------	---------------	------

2 IN 1 ABRASIVE WHEEL (CUTTING AND DEBURRING)

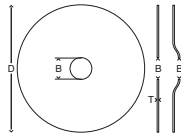

B-50360	115	2	22.23	SA46P	10	1
B-51655	125	2	22.23	SA46P	10	1

0.8MM THIN SLITTING DISC (CUTTING)

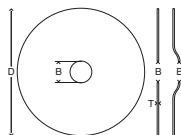

B-45727	115	0.8	22.23	Z60T	25	1
B-45733	125	0.8	22.23	Z60T	25	1

CUT-OFF WHEELS FOR METAL

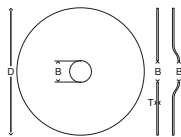

FLAT - TYPE 41 STANDARD							***
D-18655	100	2.5	16	A30S	50	1	
D-18661	115	2.5	22.23	A30S	50	1	
D-18677	125	2.5	22.23	A30S	50	1	
D-18683	180	2.5	22.23	A30S	50	1	
D-18699	230	2.5	22.23	A30S-BF	100	1	
B-64696-5	355	2.5	25.4	A36P		5	
FLAT - TYPE 41 PRO							****
A-85298	100	2.5	16	A30R	25	1	
A-85307	115	2.5	22.23	A30R	25	1	
A-85313	125	2.5	22.23	A30R	25	1	
A-85329	180	2.5	22.23	A30R	25	1	
P-26054	230	3	22.23	A30R	100	1	
DEPRESSED CENTER - TYPE 42 STANDARD							***
D-18552	100	3	16	A30S	25	1	
D-18568	115	3	22.23	A30S	25	1	
D-18574	125	3	22.23	A30S	25	1	
DEPRESSED CENTER - TYPE 42 PRO							****
A-83587	100	3	16	A30T	25	1	
A-83593	115	3	22.23	A30T	40	1	
P-30271	180	3	22.23	A30T	50	1	

CUT-OFF WHEELS FOR STONE

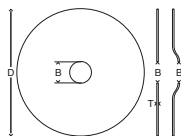

FLAT CENTER - TYPE 41 STANDARD							***
D-18708	100	3	16	C30S-BF	400	1	
D-18714	115	3	22.23	C30T	50	1	
D-18742	230	3	22.23	C30S-BF	100	1	
FLAT CENTER - TYPE 41 PRO							****
A-86739	100	3	16	C30T	25	1	
A-85357	115	3	22.23	C30T	30	1	
A-85363	125	3	22.23	C30T	25	1	
A-85379	180	3	22.23	C30T	25	1	
A-85385	230	3	22.23	C30T		1	
DEPRESSED CENTER - TYPE 42 STANDARD							***
D-18605	100	3	16	C30T	25	1	
D-18611	115	3	22.23	C30T	25	1	
D-18627	125	3	22.23	C30T	25	1	
D-18633	180	3	22.23	C30T	25	1	
D-18649	230	3	22.23	C30T	100	1	
DEPRESSED CENTER - TYPE 42 PRO							****
A-86745	100	3	16	C30T	25	1	
A-85254	115	3	22.23	C30T	40	1	
A-85260	125	3	22.23	C30T	40	1	
A-85276	180	3	22.23	C30T	15	1	
A-85282	230	3	22.23	C30T	15	1	

CUTTING DISC FOR ALUMINIUM

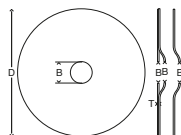

DEPRESSED CENTER - TYPE 42 PRO							****
P-67365	115	3.2	22.23	C36R	50	1	
P-67371	180	3.2	22.23	C36R	50	1	
P-67387	230	3.2	22.23	C36R	50	1	

THIN SLITTING DISC FOR STAINLESS STEEL



*10 pack of discs come in a tin

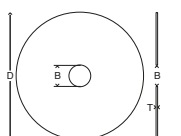

FLAT - TYPE 41 STANDARD							***
D-18764-10	115	1.2	22.23	WA60T	10	10*	
D-18764	115	1.2	22.23	WA60T	10	10*	
D-18770-10	125	1.2	22.23	WA60T	10	10*	
D-18786	180	1.2	22.23	A60T	50	1	
D-18792	230	1.2	22.23	A60T	50	1	
FLAT - TYPE 41 PRO							****
B-12201-10	100	1	16	A60T	40	10	
B-12217-10	115	1	22.23	A60T	50	10	
B-12239-10	125	1	22.23	A60T	50	10	
B-12273-10	230	1.6	22.23	A60T	40	10	

BONDED ABRASIVES

Part No.	D mm	T mm	B mm	ID Code	Master Carton	Pack
----------	------	------	------	---------	---------------	------

GRINDING DISC FOR METAL



LONG LIFE

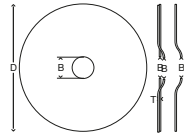

DEPRESSED CENTRE - TYPE 27 STANDARD ***

D-18443	100	6	16	A24R	25	1
D-18459	115	6	22.23	A24R	25	1
D-18471	180	6	22.23	A24R	25	1
D-18487	230	6	22.23	A24R-BF	50	1

DEPRESSED CENTRE - TYPE 27 PRO ****

A-80905	100	4	16	A36P	25	1
A-85391	100	6	16	A36P	25	1
A-80927	115	6	22.23	A36P	25	1
A-80933	125	6	22.23	A36P	25	1
A-80949	180	6	22.23	A36P	25	1
P-35368	230	6	22.23	A36P	50	1

DEPRESSED CENTRE - TYPE 27 LONG LIFE PRO ****

B-21107	100	6	16	A24R	25	1
B-21113	115	6	22.23	A24R	25	1
B-21129	125	6	22.23	A24R	25	1
B-21135	180	6	22.23	A24R	25	1
B-21141	230	6	22.23	A24R	25	1

DEPRESSED CENTRE - TYPE 27 CERAMIC GRAIN LONG LIFE PRO

B-66911	115	7	22.23	A24P	25	10
B-66927	125	7	22.23	A24P	25	10

GRINDING DISC FOR ALUMINIUM

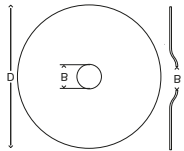

LONG LIFE PRO

B-17706	100	6	16	A36N	25	1
B-14560	115	6	22.23	A36N	25	1
B-17653	125	6	22.23	A36N	25	1
B-14576	180	6	22.23	A36N	10	1
B-14582	230	6	22.23	A36N	10	1

CUTTING DISC - ELECTRIC & PETROL CUTTERS

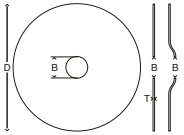

12"

P-24474	300	3	20	A30R - metal	25	1
P-25513	300	3	22.23	A30R - metal	25	1
P-24468	300	3	20	C24R-BF - stone	25	1
P-25529	300	3	22.23	C24R-BF - stone	25	1

16"

724417-0	400	3	25.4	A24PBF - metal	10	1
----------	-----	---	------	----------------	----	---

ABRASIVE DISC FOR X-LOCK GRINDER



XLOCK

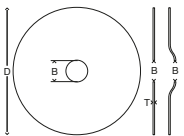

E-00365	115			A36P		1
E-00371	115			WA36N		1
E-00387	115			A60T		1
E-00393	125			A36P		1
E-00402	125			WA36N		1
E-00418	125			A60T		1

CHOP SAW WHEEL PACKS OF 5



DO NOT USE WITH PETROL CUTTERS

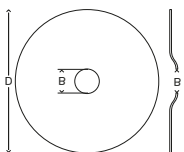

B-10665-5	355	3	25.4	A36PBF		5
B-64565-5	355	2.8	25.4	A30P		5

GRINDING WHEEL FOR STRAIGHT GRINDERS

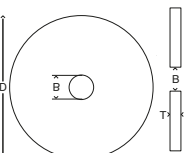

GS5000

B-28662	125	20	20	A24P	100	1
B-28678	125	20	20	A36P	100	1

GS6000

B-28684	150	20	20	A24P	50	1
B-28690	150	20	20	A36P	50	1

BONDED ABRASIVES: PADS, WRENCHES, HANDLES

RUBBER BACKING PADS



Part No.	Details	D mm	Pack
743009-6	For 100mm grinders	76	1
P-11623	For sanders/polishers	90	1
794187-5	For 115mm grinders	100	1
743080-0	For PW5000C	100	1
743015-1	For 125mm grinders	115	1
743081-8	For BO5041/10, 5012, 5021/31	123	1
743012-7	For 180mm grinders	170	1
743053-3	For BO5030 / BO5031 / BO5041	165	1

SUPERFLANGE



Quick release anti-lock flange for abrasive wheels.

192227-7	4.5" and 9" grinders		1
----------	----------------------	--	---

WRENCH REPLACEMENT



782420-7	All 100mm grinders	20	1
782401-1	All 100mm grinders	20	1
782423-1	All 115-125mm grinders	35	1
782412-6	DIN/imperial	28	1

REPLACEMENT HANDLES



153489-2	Grip 100-150mm		1
194514-0	Anti vibration grip 100-150mm		1
152539-0	Grip 180-230mm		1
162264-5	Anti vibration grip 180-230mm		1
194684-5	Grip attachment set		1
	GA7020/S, GA7030/S, GA7040S, GA9020/S, GA9030/S, GA9040S		

DUST COVER ATTACHMENT SETS



193903-6	9560/C, 9561H/CH/CVH/CR/CVR, 9562CH/CVH/CR/CV, 9563H/C/CV, 9564H/C/CV/CVL/CR, 9565H/C/CV/CVL/CR/CV/CLR, 9566C/CV/CR/CV		1
193956-5	GA5011, GA5021/C, GA6011, GA6021/C, GA7010C, GA9010C		1
194289-1	GA7020, GA7021, GA9020, GA7030/S, GA7040S, GA9030/S, GA9040S		1

EZYNUT



195354-9	Tool-less locking nut	180/230	1
----------	-----------------------	---------	---

Batteries & Cases
Tool Holders
Drilling
Fixing
Saw Blades
Jigsaw & Recip
Multi Tool
Diamond
Bonded Abrasives
Flap Discs
Coated Abrasives
Router Cutters
Dust Extraction
Ground Maintenance

Abrasive: Flap Discs and Wheels

Makita's range of lightweight Flap Discs and Wheels are comprised of coated abrasive fixed onto a supported backing. As the disc wears, a new abrasive faec is revealed ensuring a consistent performance throughout its lifespan and consequently they can last up to 10 times longer than conventional discs.

Available in 4 coatings profiles and 2 backing types, the range is suitable for a wide range of applications and materials including wood, paint, metals and stone.



Aluminium Oxide

Suitable for a variety of materials: Ferrous, non-ferrous materials, plastics, wood, etc.



Zirconia Aluminium

Ideal for stainless steel and metal. Most popular type amongst flap discs. Grinds as efficient as an abrasive disc. For heavy stock removal under high pressure and heat.



Silicon Carbide

Effective for sanding brick, stone and concrete. No need for water and lightweight compared to diamond wheel. Also suitable for graffiti removal from brick work.



Ceramic Aluminium Oxide

Flap disc made of next generation Zirconia Alumina. This disc is ideal not only for stainless steel also for Titanium, Nickel and other high tensile metals. The elite of the flap disc range.

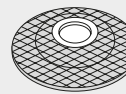

Fibre

Lightweight, flexible and quiet most popular backing for flap discs.

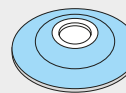

Nylon

Nylon with glassfibre reinforcement, ideal for heavy grinding.

APPLICATION GUIDE

	A	Z	C	Ce
	★			
	★			
	★★	★★		★ ★
	★★	★		★ ★
		★★		★ ★
			★★	

ALUMINIUM OXIDE

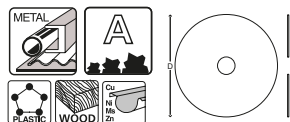

SILICON CARBIDE

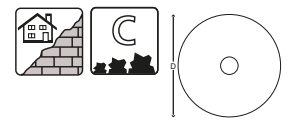

Backing Type	Backing Shape	Part No.	D mm	Grit	Pack
FIBRE GLASS ANGLED					
		D-26973	100	A36	1
		D-26989	100	A40	1
		D-26995	100	A60	1
		D-27006	100	A80	1
		D-27012	100	A120	1
		D-27028	115	A36	1
		D-27034	115	A40	1
		D-27040	115	A60	1
		D-27056	115	A80	1
		D-27062	115	A120	1
		D-27078	125	A36	1
		D-27084	125	A40	1
		D-27090	125	A60	1
		D-27109	125	A80	1
		D-27115	125	A120	1
D-27121	180	A36	1		
D-27137	180	A40	1		
D-27143	180	A60	1		
D-27159	180	A80	1		
D-27165	180	A120	1		
FIBRE GLASS FLAT					
		D-27171	100	A36	1
		D-27187	100	A40	1
		D-27193	100	A60	1
		D-27202	100	A80	1
		D-27218	100	A120	1
		D-27224	115	A36	1
		D-27230	115	A40	1
		D-27246	115	A60	1
		D-27252	115	A80	1
		D-27268	115	A120	1
		D-27274	125	A36	1
		D-27280	125	A40	1
		D-27296	125	A60	1
		D-27305	125	A80	1
		D-27311	125	A120	1
D-27327	180	A36	1		
D-27333	180	A40	1		
D-27349	180	A60	1		
D-27355	180	A80	1		
D-27361	180	A120	1		

Backing Type	Backing Shape	Part No.	D mm	Grit	Pack
FIBRE GLASS FLAT					
		D-27975	100	C36	1
		D-27981	100	C40	1
		D-27997	100	C60	1
		D-28008	100	C80	1
		D-28014	100	C120	1
		D-28020	115	C36	1
		D-28036	115	C40	1
		D-28042	115	C60	1
		D-28058	115	C80	1
		D-28064	115	C120	1
		D-28070	125	C36	1
		D-28086	125	C40	1
		D-28092	125	C60	1
		D-28101	125	C80	1
		D-28117	125	C120	1
D-28123	180	C36	1		
D-28139	180	C40	1		
D-28145	180	C60	1		
D-28151	180	C80	1		
D-28167	180	C120	1		
NYLON FLAT					
		D-28173	115	C80	1
		D-28189	115	C120	1
		D-28195	115	C180	1
		D-28204	115	C320	1
		D-28210	180	C80	1
		D-28226	180	C120	1
D-28232	180	C180	1		
D-28248	180	C320	1		

Batteries & Cases
Tool Holders
Drilling
Fixing
Saw Blades
Jigsaw & Recip
Multi Tool
Diamond
Bonded Abrasives
Flap Discs
Coated Abrasives
Router Cutters
Dust Extraction
Ground Maintenance

ABRASIVE: FLAP DISCS

ZIRCONIA ALUMINIUM



Backing Type	Backing Shape	Part No.	D mm	Grit	Pack
FIBRE GLASS ANGLED					
		D-27377	100	36	1
		D-27383	100	40	1
		D-27399	100	60	1
		D-27408	100	80	1
		D-27414	100	120	1
		D-27420	115	36	1
		D-27436	115	40	1
		D-27442	115	60	1
		D-27458	115	80	1
		D-27464	115	120	1
		D-27470	125	36	1
		D-27486	125	40	1
		D-27492	125	60	1
		D-27501	125	80	1
		D-27517	125	120	1
		D-27523	180	36	1
		D-27539	180	40	1
		D-27545	180	60	1
D-27551	180	80	1		
D-27567	180	120	1		
FIBRE GLASS FLAT					
		D-27573	100	36	1
		D-27589	100	40	1
		D-27595	100	60	1
		D-27604	100	80	1
		D-27610	100	120	1
		D-27626	115	36	1
		D-27632	115	40	1
		D-27648	115	60	1
		D-27654	115	80	1
		D-27660	115	120	1
		D-27676	125	36	1
		D-27698	125	60	1
		D-27713	125	120	1
		D-27729	180	36	1
		D-27735	180	40	1
		D-27741	180	60	1
		D-27757	180	80	1
		D-27763	180	120	1
NYLON FLAT					
		D-27779	100	36	1
		D-27785	100	40	1
		D-27791	100	60	1
		D-27800	100	80	1
		D-27816	100	120	1
		D-27822	115	36	1
		D-27838	115	40	1
		D-27844	115	60	1
		D-27850	115	80	1
		D-27866	115	120	1
		D-27872	125	36	1
		D-27888	125	40	1
		D-27894	125	60	1
		D-27919	125	120	1
		D-27925	180	36	1
		D-27931	180	40	1
		D-27947	180	60	1
		D-27953	180	80	1
D-27969	180	120	1		
FIBRE GLASS ANGLED					
		D-63703	100	40	1
		D-63719	100	60	1
		D-63725	100	80	1
		D-63731	100	120	1
		D-63747	115	40	1
		D-63753	115	60	1
		D-63769	115	80	1
		D-63775	115	120	1
		D-63781	125	40	1
		D-63797	125	60	1
		D-63806	125	80	1
		D-63812	125	120	1
		D-63828	180	40	1
		D-63834	180	60	1
		D-63840	180	80	1
		D-63856	180	120	1

CERAMIC ALUMINIUM OXIDE



Backing Type	Backing Shape	Part No.	D mm	Grit	Pack		
FIBRE GLASS ANGLED							
		D-28254	100	40	1		
		D-28260	100	60	1		
		D-28276	100	80	1		
		D-28282	100	120	1		
		D-28298	115	40	1		
		D-28307	115	60	1		
		D-28313	115	80	1		
		D-28329	115	120	1		
		D-28335	125	40	1		
		D-28341	125	60	1		
		D-28357	125	80	1		
		D-28363	125	120	1		
		D-28379	180	40	1		
		D-28385	180	60	1		
		D-28391	180	80	1		
		D-28400	180	120	1		
		FIBRE GLASS FLAT					
				D-28416	100	40	1
D-28422	100			60	1		
D-28438	100			80	1		
D-28444	100			120	1		
D-28450	115			40	1		
D-28466	115			60	1		
D-28472	115			80	1		
D-28488	115			120	1		
D-28494	125			40	1		
D-28503	125			60	1		
D-28519	125			80	1		
D-28525	125			120	1		
D-28531	180			40	1		
D-28547	180			60	1		
D-28553	180			80	1		
D-28569	180			120	1		

SURFACE CONDITIONING



Recommended that you use Surface conditioning flap disc for finish after using the standard flap disc. Suitable for use on stainless steel, it contains very little Fe, S, and CL, making it rust resistant.

Backing Type	Backing Shape	Part No.	D mm	Grit	Pack
FIBRE GLASS ANGLED					
		B-40711	100	Coarse	1
		B-40727	100	Medium	1
		B-40733	100	V.Fine	1
		B-40749	100	S.Fine	1
		B-40755	115	Coarse	1
		B-40761	115	Medium	1
		B-40777	115	V.Fine	1
		B-40783	115	S.Fine	1
		B-40799	125	Coarse	1
		B-40808	125	Medium	1
		B-40814	125	V.Fine	1
		B-40820	125	S.Fine	1
		B-40836	180	Coarse	1
		B-40842	180	Medium	1
		B-40858	180	V.Fine	1
B-40864	180	S.Fine	1		
FIBRE GLASS FLAT					
		B-40870	100	Coarse	1
		B-40886	100	Medium	1
		B-40892	100	V.Fine	1
		B-40901	100	S.Fine	1
		B-40917	115	Coarse	1
		B-40923	115	Medium	1
		B-40939	115	V.Fine	1
		B-40945	115	S.Fine	1
		B-40951	125	Coarse	1
		B-40967	125	Medium	1
		B-40973	125	V.Fine	1
		B-40989	125	S.Fine	1
		B-40995	180	Coarse	1
		B-41006	180	Medium	1
		B-41012	180	V.Fine	1
B-41028	180	S.Fine	1		

FLAP WHEELS

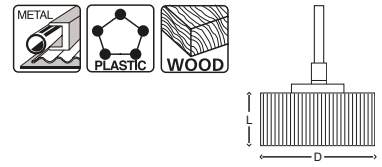

Compatible for use with drills and die grinders, Flap wheels are the ideal solution to sanding and finishing curved surfaces, such as insides of pipes, grooves, contours.

Type	Part No.	D mm	L mm	Grit	Grit Type
50.8MM X 25.4MM - 6MM SHANK					
	B-36865	50.8	25.4	A40	Coarse
	B-36871	50.8	25.4	A60	Coarse
	B-36887	50.8	25.4	A80	Medium
	B-36893	50.8	25.4	A120	Medium
	B-36902	50.8	25.4	A180	Fine
50.8MM X 38.1MM - 6MM SHANK					
	B-36918	50.8	38.1	A40	Coarse
	B-36924	50.8	38.1	A60	Coarse
	B-36930	50.8	38.1	A80	Medium
	B-36946	50.8	38.1	A120	Medium
	B-36952	50.8	38.1	A180	Fine
50.8MM X 50.8MM - 6MM SHANK					
	B-36968	50.8	50.8	A40	Coarse
	B-36974	50.8	50.8	A60	Coarse
	B-36980	50.8	50.8	A80	Medium
	B-36996	50.8	50.8	A120	Medium
	B-37007	50.8	50.8	A180	Fine
63.5MM X 25.4MM - 6MM SHANK					
	B-37013	63.5	25.4	A40	Coarse
	B-37029	63.5	25.4	A60	Coarse
	B-37035	63.5	25.4	A80	Medium
	B-37041	63.5	25.4	A120	Medium
	B-37057	63.5	25.4	A180	Fine
76.0MM X 25.4MM - 6MM SHANK					
	B-37063	76.0	25.4	A40	Coarse
	B-37079	76.0	25.4	A60	Coarse
	B-37085	76.0	25.4	A80	Medium
	B-37091	76.0	25.4	A120	Medium
	B-37100	76.0	25.4	A180	Fine
76.0MM X 50.8MM - 6MM SHANK					
	B-37116	76.0	50.8	A40	Coarse
	B-37122	76.0	50.8	A60	Coarse
	B-37138	76.0	50.8	A80	Medium
	B-37144	76.0	50.8	A120	Medium
	B-37150	76.0	50.8	A180	Fine

STRIP DISCS

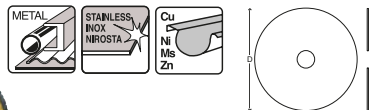

Strong stripping power without causing damage to the work piece. The flexible fibre bond allows for work on irregular surfaces. Applications: Removing paint, rust and weld discolouration.

Backing Type	Part No.	D mm	B mm	Type	Pack
FIBRE GLASS					
	B-28961	100	16	Black (Standard)	1
	B-28977	115	22.23	Black (Standard)	1
	B-28983	125	22.23	Black (Standard)	1
	B-28999	180	22.23	Black (Standard)	1
	B-29000	100	16	Purple (Long Life)	1
	B-29016	115	22.23	Purple (Long Life)	1
	B-29022	125	22.23	Purple (Long Life)	1
	B-29038	180	22.23	Purple (Long Life)	1
NYLON					
	B-29044	100	16	Black (standard)	1
	B-29050	115	22.23	Black (standard)	1
	B-29066	125	22.23	Black (standard)	1
	B-36239	180	22.23	Black (standard)	1
	B-36245	100	16	Purple (Long Life)	1
	B-36251	115	22.23	Purple (Long Life)	1
	B-36267	125	22.23	Purple (Long Life)	1
B-36273	180	22.23	Purple (Long Life)	1	

HOW STRIP DISCS WORK

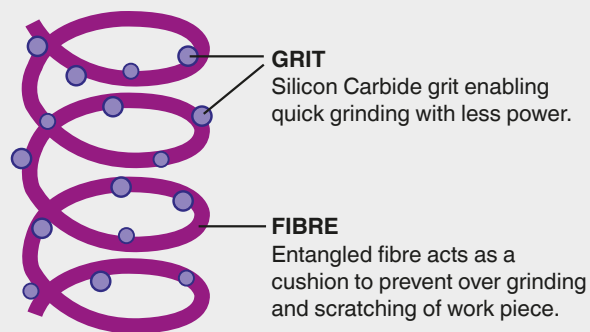

Abrasive: Belts and Sheets

Cutting operations can leave a roughness on the material surface which often needs to be removed before the item can be used in a finished application. Coated abrasives are a flexible option for removing rough surface and edges. They are fine enough to produce a smooth surface finish where required. Makita offers a wide range of sanding products suitable for a variety of applications including wood, steel and white abrasives.



Components

A coated abrasive comprises 3 major components: abrasive grit, specific to the application; backing material to hold the abrasive and a bonding agent to glue the grit to backing. The quality of the materials and manufacturing method are critical factors in matching long life with fast cutting performance.



Grit size

The grit size is determined by the number of holes per square inch required by a sieve designed to collect the grit. So the smaller the number – the coarser the cut.

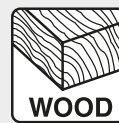

Applications:

Wood/Painted wood

Makita abrasives for sanding wood are made from primary grade aluminium oxide durable bonding and the most suitable backing material. Thanks to the structure of the grain, this abrasive combines the optimum characteristics of long life with excellent stock removal.

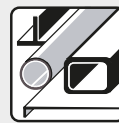

Regular steel

Makita abrasives work extremely well on metal surfaces also. For any applications where static build up can lead to the paper clogging, (principally on varnished surfaces, plastic and automotive applications)



White Abrasives

White Abrasives have a longer life due to the White Aluminium Oxide with stearate which provides an anti clogging quality. This results in excellent surface finish on paint, varnish and fillers.

COATED ABRASIVES: BELTS

SANDING BELTS



Size mm	Grit	Part No.	Model	Holes	Velcro	Pack
6 x 533mm						
6 x 533	40	P-43181	9032	0	N	5
6 x 533	60	P-43197	9032	0	N	5
6 x 533	80	P-43206	9032	0	N	5
6 x 533	100	P-43212	9032	0	N	5
6 x 533	120	P-43228	9032	0	N	5
6 x 533	150	P-43234	9032	0	N	5
6 x 533	240	P-43240	9032	0	N	5
9 x 533mm						
9 x 533	40	P-43256	9032	0	N	5
9 x 533	60	P-43262	9032	0	N	5
9 x 533	80	P-43278	9032	0	N	5
9 x 533	100	P-43284	9032	0	N	5
9 x 533	120	P-43290	9032	0	N	5
9 x 533	150	P-43309	9032	0	N	5
9 x 533	240	P-43315	9032	0	N	5
13 x 533mm						
13 x 533	40	P-43321	9032	0	N	5
13 x 533	60	P-43337	9032	0	N	5
13 x 533	80	P-43343	9032	0	N	5
13 x 533	100	P-43359	9032	0	N	5
13 x 533	120	P-43365	9032	0	N	5
13 x 533	150	P-43371	9032	0	N	5
13 x 533	240	P-43387	9032	0	N	5
30 x 533mm						
30 x 533	40	P-36675	9031	0	N	5
30 x 533	60	P-36681	9031	0	N	5
30 x 533	80	P-36697	9031	0	N	5
30 x 533	100	P-36706	9031	0	N	5
30 x 533	120	P-36712	9031	0	N	5
30 x 533	150	P-36728	9031	0	N	5
30 x 533	240	P-36734	9031	0	N	5
30 x 533mm - ZIRCONIUM FOR WOOD / METAL / PLASTIC						
30 x 533	40	P-00088	9031	0	N	5
30 x 533	60	P-00094	9031	0	N	5
30 x 533	80	P-00103	9031	0	N	5
30 x 533	100	P-00119	9031	0	N	5
30 x 533	120	P-00125	9031	0	N	5
30 x 533	150	P-00131	9031	0	N	5
30 x 533mm - SILICON CARBIDE FOR WOOD / PLASTIC / GLASS						
30 x 533	40	P-01395	9031	0	N	5
30 x 533	60	P-01404	9031	0	N	5
30 x 533	80	P-01199	9031	0	N	5
30 x 533	100	P-01208	9031	0	N	5
30 x 533	120	P-01214	9031	0	N	5
30 x 533	150	P-01220	9031	0	N	5
30 x 533	180	P-01236	9031	0	N	5
76 x 457mm						
76 x 457	40	P-37091	9911: Skil B&D	0	N	5
76 x 457	60	P-37100	9911: Skil B&D	0	N	5
76 x 457	80	P-37116	9911: Skil B&D	0	N	5
76 x 457	100	P-37122	9911: Skil B&D	0	N	5
76 x 457	120	P-37138	9911: Skil B&D	0	N	5
76 x 457	150	P-37144	9911: Skil B&D	0	N	5
76 x 457	150	P-44971	9911: Skil B&D	0	N	25
76 x 457	240	P-37150	9911: Skil B&D	0	N	5
76 x 457	40/80/120	P-37166	9911: Skil B&D Mix pack	0	N	3
76 x 533mm						
76 x 533	40	P-37172	9903: B&D DeWalt AEG Milwaukee Hitachi Ryobi Metabo and Skil	0	N	5
76 x 533	60	P-37188	9903: B&D DeWalt AEG Milwaukee Hitachi Ryobi Metabo and Skil	0	N	5
76 x 533	80	P-37194	9903: B&D DeWalt AEG Milwaukee Hitachi Ryobi Metabo and Skil	0	N	5
76 x 533	100	P-37203	9903: B&D DeWalt AEG Milwaukee Hitachi Ryobi Metabo and Skil	0	N	5
76 x 533	120	P-37219	9903: B&D DeWalt AEG Milwaukee Hitachi Ryobi Metabo and Skil	0	N	5
76 x 533	150	P-37225	9903: B&D DeWalt AEG Milwaukee Hitachi Ryobi Metabo and Skil	0	N	5
76 x 533	240	P-37231	9903: B&D DeWalt AEG Milwaukee Hitachi Ryobi Metabo and Skil	0	N	5
76 x 533	40	P-37247	9903: B&D DeWalt AEG Milwaukee Hitachi Ryobi Metabo and Skil	0	N	25
76 x 533	60	P-37253	9903: B&D DeWalt AEG Milwaukee Hitachi Ryobi Metabo and Skil	0	N	25
76 x 533	80	P-37269	9903: B&D DeWalt AEG Milwaukee Hitachi Ryobi Metabo and Skil	0	N	25
76 x 533	100	P-37275	9903: B&D DeWalt AEG Milwaukee Hitachi Ryobi Metabo and Skil	0	N	25
76 x 533	120	P-37281	9903: B&D DeWalt AEG Milwaukee Hitachi Ryobi Metabo and Skil	0	N	25
76 x 533	150	P-37297	9903: B&D DeWalt AEG Milwaukee Hitachi Ryobi Metabo and Skil	0	N	25
76 x 533	240	P-37306	9903: B&D DeWalt AEG Milwaukee Hitachi Ryobi Metabo and Skil	0	N	25
76 x 533	80	P-43418	9903: B&D DeWalt AEG Milwaukee Hitachi Ryobi Metabo and Skil	0	N	50
76 x 610mm						
76 x 610	40	P-37312	9923DB 9920: Hitachi Ryobi	0	N	5
76 x 610	60	P-37328	9923DB 9920: Hitachi Ryobi	0	N	5
76 x 610	80	P-37334	9923DB 9920: Hitachi Ryobi	0	N	5
76 x 610	100	P-37340	9923DB 9920: Hitachi Ryobi	0	N	5
76 x 610	120	P-37356	9923DB 9920: Hitachi Ryobi	0	N	5
76 x 610	150	P-37362	9923DB 9920: Hitachi Ryobi	0	N	5
76 x 610	240	P-37378	9923DB 9920: Hitachi Ryobi	0	N	5

COATED ABRASIVES: BELTS

SANDING BELTS

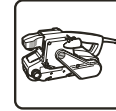

Size mm	Grit	Part No.	Model	Holes	Velcro	Pack
100 x 560mm 5 Pack						
100 x 560	40	P-36740	B&D DeWalt AEG Milwaukee Ryobi	0	N	5
100 x 560	60	P-36756	B&D DeWalt AEG Milwaukee Ryobi	0	N	5
100 x 560	80	P-36762	B&D DeWalt AEG Milwaukee Ryobi	0	N	5
100 x 560	100	P-36778	B&D DeWalt AEG Milwaukee Ryobi	0	N	5
100 x 560	120	P-36784	B&D DeWalt AEG Milwaukee Ryobi	0	N	5
100 x 560	150	P-36790	B&D DeWalt AEG Milwaukee Ryobi	0	N	5
100 x 560	240	P-36809	B&D DeWalt AEG Milwaukee Ryobi	0	N	5
100 x 560mm 25 Pack						
100 x 560	40	P-36815	B&D DeWalt AEG Milwaukee Ryobi	0	N	25
100 x 560	60	P-36821	B&D DeWalt AEG Milwaukee Ryobi	0	N	25
100 x 560	80	P-36837	B&D DeWalt AEG Milwaukee Ryobi	0	N	25
100 x 560	100	P-36843	B&D DeWalt AEG Milwaukee Ryobi	0	N	25
100 x 560	120	P-36859	B&D DeWalt AEG Milwaukee Ryobi	0	N	25
100 x 560	150	P-36865	B&D DeWalt AEG Milwaukee Ryobi	0	N	25
100 x 560	240	P-36871	B&D DeWalt AEG Milwaukee Ryobi	0	N	25
100 x 610mm 5 Pack						
100 x 610	40	P-36887	9401 9403 9404 9924DB: Hitachi Ryobi	0	N	5
100 x 610	60	P-36893	9401 9403 9404 9924DB: Hitachi Ryobi	0	N	5
100 x 610	80	P-36902	9401 9403 9404 9924DB: Hitachi Ryobi	0	N	5
100 x 610	100	P-36918	9401 9403 9404 9924DB: Hitachi Ryobi	0	N	5
100 x 610	120	P-36924	9401 9403 9404 9924DB: Hitachi Ryobi	0	N	5
100 x 610	150	P-36930	9401 9403 9404 9924DB: Hitachi Ryobi	0	N	5
100 x 610	240	P-36946	9401 9403 9404 9924DB: Hitachi Ryobi	0	N	5
100 x 610mm 25 Pack						
100 x 610	40	P-36952	9401 9403 9404 9924DB: Hitachi Ryobi	0	N	25
100 x 610	60	P-36968	9401 9403 9404 9924DB: Hitachi Ryobi	0	N	25
100 x 610	80	P-36974	9401 9403 9404 9924DB: Hitachi Ryobi	0	N	25
100 x 610	100	P-36980	9401 9403 9404 9924DB: Hitachi Ryobi	0	N	25
100 x 610	120	P-36996	9401 9403 9404 9924DB: Hitachi Ryobi	0	N	25
100 x 610	150	P-37007	9401 9403 9404 9924DB: Hitachi Ryobi	0	N	25
100 x 610	240	P-37013	9401 9403 9404 9924DB: Hitachi Ryobi	0	N	25
100 x 610mm 50 Pack						
100 x 610	40	P-43468	9401 9403 9404 9924DB: Hitachi Ryobi	0	N	50
100 x 610	60	P-43474	9401 9403 9404 9924DB: Hitachi Ryobi	0	N	50
100 x 610	80	P-43480	9401 9403 9404 9924DB: Hitachi Ryobi	0	N	50
100 x 610	100	P-43496	9401 9403 9404 9924DB: Hitachi Ryobi	0	N	50
100 x 610	120	P-43505	9401 9403 9404 9924DB: Hitachi Ryobi	0	N	50
100 x 610	150	P-43511	9401 9403 9404 9924DB: Hitachi Ryobi	0	N	50
100 x 610	240	P-43527	9401 9403 9404 9924DB: Hitachi Ryobi	0	N	50
100 x 620mm 5 Pack						
100 x 620	40	P-37029	9924DB: Bosch AEG Milwaukee Metabo	0	N	5
100 x 620	60	P-37035	9924DB: Bosch AEG Milwaukee Metabo	0	N	5
100 x 620	80	P-37041	9924DB: Bosch AEG Milwaukee Metabo	0	N	5
100 x 620	100	P-37057	9924DB: Bosch AEG Milwaukee Metabo	0	N	5
100 x 620	120	P-37063	9924DB: Bosch AEG Milwaukee Metabo	0	N	5
100 x 620	150	P-37079	9924DB: Bosch AEG Milwaukee Metabo	0	N	5
100 x 620	240	P-37085	9924DB: Bosch AEG Milwaukee Metabo	0	N	5

ORBITAL SANDING SHEETS - 1/2 SHEET SANDERS

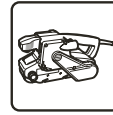
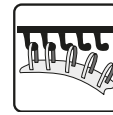
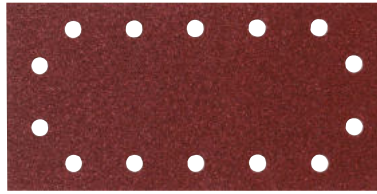

Size mm	Grit	Part No.	Model	Holes	Velcro	Pack
RED 115 x 229mm						
115 x 229	40	P-33174	9046 BO4900	5+5	Y	10
115 x 229	60	P-33180	9046 BO4900	5+5	Y	10
115 x 229	80	P-33196	9046 BO4900	5+5	Y	10
115 x 229	100	P-33205	9046 BO4900	5+5	Y	10
115 x 229	120	P-33211	9046 BO4900	5+5	Y	10
115 x 229	150	P-33227	9046 BO4900	5+5	Y	10
115 x 229	180	P-33233	9046 BO4900	5+5	Y	10
115 x 229	240	P-33249	9046 BO4900	5+5	Y	10
115 x 229	40	P-35726	9046 BO4900	5+5	Y	50
115 x 229	60	P-35732	9046 BO4900	5+5	Y	50
115 x 229	80	P-35748	9046 BO4900	5+5	Y	50
115 x 229	100	P-35754	9046 BO4900	5+5	Y	50
115 x 229	150	P-35760	9046 BO4900	5+5	Y	50
115 x 229	150	P-35776	9046 BO4900	5+5	Y	50
115 x 229	180	P-35782	9046 BO4900	5+5	Y	50
115 x 229	240	P-35798	9046 BO4900	5+5	Y	50
115 x 229	40	P-43022	Bosch B&D AEG Milwaukee Fein Festo Metabo	5+5+2+2	Y	10
115 x 229	60	P-43038	Bosch B&D AEG Milwaukee Fein Festo Metabo	5+5+2+2	Y	10
115 x 229	80	P-43044	Bosch B&D AEG Milwaukee Fein Festo Metabo	5+5+2+2	Y	10
115 x 229	100	P-43050	Bosch B&D AEG Milwaukee Fein Festo Metabo	5+5+2+2	Y	10
115 x 229	120	P-43066	Bosch B&D AEG Milwaukee Fein Festo Metabo	5+5+2+2	Y	10
115 x 229	150	P-43072	Bosch B&D AEG Milwaukee Fein Festo Metabo	5+5+2+2	Y	10
115 x 229	180	P-43088	Bosch B&D AEG Milwaukee Fein Festo Metabo	5+5+2+2	Y	10
115 x 229	240	P-43094	Bosch B&D AEG Milwaukee Fein Festo Metabo	5+5+2+2	Y	10
115 x 229	40	P-43103	Bosch B&D AEG Milwaukee Fein Festo Metabo	5+5+2+2	Y	50
115 x 229	60	P-43119	Bosch B&D AEG Milwaukee Fein Festo Metabo	5+5+2+2	Y	50
115 x 229	80	P-43125	Bosch B&D AEG Milwaukee Fein Festo Metabo	5+5+2+2	Y	50
115 x 229	100	P-43131	Bosch B&D AEG Milwaukee Fein Festo Metabo	5+5+2+2	Y	50
115 x 229	120	P-43147	Bosch B&D AEG Milwaukee Fein Festo Metabo	5+5+2+2	Y	50
115 x 229	150	P-43153	Bosch B&D AEG Milwaukee Fein Festo Metabo	5+5+2+2	Y	50
115 x 229	180	P-43169	Bosch B&D AEG Milwaukee Fein Festo Metabo	5+5+2+2	N	50
115 x 229	240	P-43175	Bosch B&D AEG Milwaukee Fein Festo Metabo	5+5+2+2	N	50
RED 115 x 280mm						
115 x 280	40	P-33009	9046 BO4900: Bosch B&D DeWalt AEG Milwaukee Festool Metabo	5+5+2+2	N	10
115 x 280	60	P-33015	9046 BO4900: Bosch B&D DeWalt AEG Milwaukee Festool Metabo	5+5+2+2	N	10
115 x 280	80	P-33021	9046 BO4900: Bosch B&D DeWalt AEG Milwaukee Festool Metabo	5+5+2+2	N	10
115 x 280	100	P-33037	9046 BO4900: Bosch B&D DeWalt AEG Milwaukee Festool Metabo	5+5+2+2	N	10
115 x 280	120	P-33043	9046 BO4900: Bosch B&D DeWalt AEG Milwaukee Festool Metabo	5+5+2+2	N	10
115 x 280	150	P-33059	9046 BO4900: Bosch B&D DeWalt AEG Milwaukee Festool Metabo	5+5+2+2	N	10
115 x 280	180	P-33065	9046 BO4900: Bosch B&D DeWalt AEG Milwaukee Festool Metabo	5+5+2+2	N	10
115 x 280	240	P-33071	9046 BO4900: Bosch B&D DeWalt AEG Milwaukee Festool Metabo	5+5+2+2	N	10
115 x 280	40	P-35645	9046: B&D DeWalt AEG Milwaukee Metabo Festool	5+5+2+2	N	50
115 x 280	60	P-35651	9046: B&D DeWalt AEG Milwaukee Metabo Festool	5+5+2+2	N	50
115 x 280	80	P-35667	9046: B&D DeWalt AEG Milwaukee Metabo Festool	5+5+2+2	N	50
115 x 280	100	P-35673	9046: B&D DeWalt AEG Milwaukee Metabo Festool	5+5+2+2	N	50
115 x 280	120	P-35689	9046: B&D DeWalt AEG Milwaukee Metabo Festool	5+5+2+2	N	50
115 x 280	150	P-35695	9046: B&D DeWalt AEG Milwaukee Metabo Festool	5+5+2+2	N	50
115 x 280	180	P-35704	9046: B&D DeWalt AEG Milwaukee Metabo Festool	5+5+2+2	N	50
115 x 280	240	P-35710	9046: B&D DeWalt AEG Milwaukee Metabo Festool	5+5+2+2	N	50
115 x 280	40	P-36267	9045N 9046: B&D DeWalt AEG Milwaukee Metabo Festool	0	N	10
115 x 280	60	P-32976	9045N 9046: B&D DeWalt AEG Milwaukee Metabo Festool	0	N	10
115 x 280	80	P-36273	9045N 9046: B&D DeWalt AEG Milwaukee Metabo Festool	0	N	10
115 x 280	100	P-32982	9045N 9046: B&D DeWalt AEG Milwaukee Metabo Festool	0	N	10
115 x 280	120	P-36289	9045N 9046: B&D DeWalt AEG Milwaukee Metabo Festool	0	N	10
115 x 280	150	P-32998	9045N 9046: B&D DeWalt AEG Milwaukee Metabo Festool	0	N	10
115 x 280	180	P-36295	9045N 9046: B&D DeWalt AEG Milwaukee Metabo Festool	0	N	10
115 x 280	240	P-36304	9045N 9046: B&D DeWalt AEG Milwaukee Metabo Festool	0	N	10
115 x 280	40	P-36310	9045N 9046: B&D DeWalt AEG Milwaukee Metabo Festool	0	N	50
115 x 280	60	P-36326	9045N 9046: B&D DeWalt AEG Milwaukee Metabo Festool	0	N	50
115 x 280	80	P-36332	9045N 9046: B&D DeWalt AEG Milwaukee Metabo Festool	0	N	50
115 x 280	100	P-36348	9045N 9046: B&D DeWalt AEG Milwaukee Metabo Festool	0	N	50
115 x 280	120	P-36354	9045N 9046: B&D DeWalt AEG Milwaukee Metabo Festool	0	N	50
115 x 280	150	P-36360	9045N 9046: B&D DeWalt AEG Milwaukee Metabo Festool	0	N	50
115 x 280	180	P-36376	9045N 9046: B&D DeWalt AEG Milwaukee Metabo Festool	0	N	50
115 x 280	240	P-36382	9045N 9046: B&D DeWalt AEG Milwaukee Metabo Festool	0	N	50

Batteries & Cases
Tool Holders
Drilling
Fixing
Saw Blades
Jigsaw & Recip
Multi Tool
Diamond
Bonded Abrasives
Flap Discs
Coated Abrasives
Router Cutters
Dust Extraction
Ground Maintenance

ORBITAL SANDING SHEETS - 1/3 SHEET SANDERS

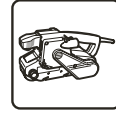
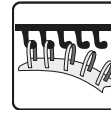

Size mm	Grit	Part No.	Model	Holes	Velcro	Pack
93 x 185mm						
93 x 185	40	P-31871	BO3700: Bosch AEG Milwaukee Hitachi Skil Metabo Festool	4+4	Y	10
93 x 185	60	P-31887	BO3700: Bosch AEG Milwaukee Hitachi Skil Metabo Festool	4+4	Y	10
93 x 185	80	P-31893	BO3700: Bosch AEG Milwaukee Hitachi Skil Metabo Festool	4+4	Y	10
93 x 185	100	P-31902	BO3700: Bosch AEG Milwaukee Hitachi Skil Metabo Festool	4+4	Y	10
93 x 185	120	P-35891	BO3700: Bosch AEG Milwaukee Hitachi Skil Metabo Festool	4+4	Y	10
93 x 185	150	P-35900	BO3700: Bosch AEG Milwaukee Hitachi Skil Metabo Festool	4+4	Y	10
93 x 185	180	P-35916	BO3700: Bosch AEG Milwaukee Hitachi Skil Metabo Festool	4+4	Y	10
93 x 185	240	P-35922	BO3700: Bosch AEG Milwaukee Hitachi Skil Metabo Festool	4+4	Y	10
93 x 185	40	P-35938	BO3700: Bosch AEG Milwaukee Hitachi Skil Metabo Festool	4+4	Y	50
93 x 185	60	P-35944	BO3700: Bosch AEG Milwaukee Hitachi Skil Metabo Festool	4+4	Y	50
93 x 185	80	P-35950	BO3700: Bosch AEG Milwaukee Hitachi Skil Metabo Festool	4+4	Y	50
93 x 185	100	P-35966	BO3700: Bosch AEG Milwaukee Hitachi Skil Metabo Festool	4+4	Y	50
93 x 185	120	P-35972	BO3700: Bosch AEG Milwaukee Hitachi Skil Metabo Festool	4+4	Y	50
93 x 185	150	P-35988	BO3700: Bosch AEG Milwaukee Hitachi Skil Metabo Festool	4+4	Y	50
93 x 185	180	P-35994	BO3700: Bosch AEG Milwaukee Hitachi Skil Metabo Festool	4+4	N	50
93 x 185	240	P-36005	BO3700: Bosch AEG Milwaukee Hitachi Skil Metabo Festool	4+4	N	50
93 x 230mm						
93 x 230	40	P-31837	9036 BO3700 BO3710 BO3711: Bosch B&D DeWalt AEG Milwaukee Metabo Festool Ryobi	4+4	N	10
93 x 230	60	P-31843	9036 BO3700 BO3710 BO3711: Bosch B&D DeWalt AEG Milwaukee Metabo Festool Ryobi	4+4	N	10
93 x 230	80	P-31859	9036 BO3700 BO3710 BO3711: Bosch B&D DeWalt AEG Milwaukee Metabo Festool Ryobi	4+4	N	10
93 x 230	100	P-31865	9036 BO3700 BO3710 BO3711: Bosch B&D DeWalt AEG Milwaukee Metabo Festool Ryobi	4+4	N	10
93 x 230	120	P-36011	9036 BO3700 BO3710 BO3711: Bosch B&D DeWalt AEG Milwaukee Metabo Festool Ryobi	4+4	N	10
93 x 230	150	P-36027	9036 BO3700 BO3710 BO3711: Bosch B&D DeWalt AEG Milwaukee Metabo Festool Ryobi	4+4	N	10
93 x 230	180	P-36033	9036 BO3700 BO3710 BO3711: Bosch B&D DeWalt AEG Milwaukee Metabo Festool Ryobi	4+4	N	10
93 x 230	240	P-36049	9036 BO3700 BO3710 BO3711: Bosch B&D DeWalt AEG Milwaukee Metabo Festool Ryobi	4+4	N	10
93 x 230	40	P-36055	9036 BO3700 BO3710 BO3711: Bosch B&D DeWalt AEG Milwaukee Metabo Festool Ryobi	4+4	N	50
93 x 230	60	P-36061	9036 BO3700 BO3710 BO3711: Bosch B&D DeWalt AEG Milwaukee Metabo Festool Ryobi	4+4	N	50
93 x 230	80	P-36077	9036 BO3700 BO3710 BO3711: Bosch B&D DeWalt AEG Milwaukee Metabo Festool Ryobi	4+4	N	50
93 x 230	100	P-36083	9036 BO3700 BO3710 BO3711: Bosch B&D DeWalt AEG Milwaukee Metabo Festool Ryobi	4+4	N	50
93 x 230	120	P-36099	9036 BO3700 BO3710 BO3711: Bosch B&D DeWalt AEG Milwaukee Metabo Festool Ryobi	4+4	N	50
93 x 230	150	P-36108	9036 BO3700 BO3710 BO3711: Bosch B&D DeWalt AEG Milwaukee Metabo Festool Ryobi	4+4	N	50
93 x 230	180	P-36114	9036 BO3700 BO3710 BO3711: Bosch B&D DeWalt AEG Milwaukee Metabo Festool Ryobi	4+4	N	50
93 x 230	240	P-36120	9036 BO3700 BO3710 BO3711: Bosch B&D DeWalt AEG Milwaukee Metabo Festool Ryobi	4+4	N	50
93 x 230	40	P-36136	9036 BO3700/10/11: Bosch B&D DeWalt AEG Milwaukee Hitachi Ryobi Metabo Festool	0	N	10
93 x 230	60	P-32948	9036 BO3700/10/11: Bosch B&D DeWalt AEG Milwaukee Hitachi Ryobi Metabo Festool	0	N	10
93 x 230	80	P-36142	9036 BO3700/10/11: Bosch B&D DeWalt AEG Milwaukee Hitachi Ryobi Metabo Festool	0	N	10
93 x 230	100	P-32954	9036 BO3700/10/11: Bosch B&D DeWalt AEG Milwaukee Hitachi Ryobi Metabo Festool	0	N	10
93 x 230	120	P-36158	9036 BO3700/10/11: Bosch B&D DeWalt AEG Milwaukee Hitachi Ryobi Metabo Festool	0	N	10
93 x 230	150	P-32960	9036 BO3700/10/11: Bosch B&D DeWalt AEG Milwaukee Hitachi Ryobi Metabo Festool	0	N	10
93 x 230	180	P-36164	9036 BO3700/10/11: Bosch B&D DeWalt AEG Milwaukee Hitachi Ryobi Metabo Festool	0	N	10
93 x 230	240	P-36170	9036 BO3700/10/11: Bosch B&D DeWalt AEG Milwaukee Hitachi Ryobi Metabo Festool	0	N	10
93 x 230	40	P-36186	9036 BO3700/10/11: Bosch B&D DeWalt AEG Milwaukee Hitachi Ryobi Metabo Festool	0	N	50
93 x 230	60	P-36192	9036 BO3700/10/11: Bosch B&D DeWalt AEG Milwaukee Hitachi Ryobi Metabo Festool	0	N	50
93 x 230	80	P-36201	9036 BO3700/10/11: Bosch B&D DeWalt AEG Milwaukee Hitachi Ryobi Metabo Festool	0	N	50
93 x 230	100	P-36217	9036 BO3700/10/11: Bosch B&D DeWalt AEG Milwaukee Hitachi Ryobi Metabo Festool	0	N	50
93 x 230	120	P-36223	9036 BO3700/10/11: Bosch B&D DeWalt AEG Milwaukee Hitachi Ryobi Metabo Festool	0	N	50
93 x 230	150	P-36239	9036 BO3700/10/11: Bosch B&D DeWalt AEG Milwaukee Hitachi Ryobi Metabo Festool	0	N	50
93 x 230	180	P-36245	9036 BO3700/10/11: Bosch B&D DeWalt AEG Milwaukee Hitachi Ryobi Metabo Festool	0	N	50
93 x 230	240	P-36251	9036 BO3700/10/11: Bosch B&D DeWalt AEG Milwaukee Hitachi Ryobi Metabo Festool	0	N	50
HOOK AND LOOP PAD						
		194930-6	Hook and loop pad for BO3700	4+4	Y	

PALM SANDERS

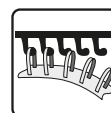
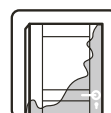
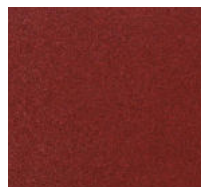

Size mm	Grit	Part No.	Model	Holes	Velcro	Pack
WHITE						
114 x 102	40	P-35807	BO4555 BO4554 BO4561: Hitachi	3+3	Y	10
114 x 102	60	P-35813	BO4555 BO4554 BO4561: Hitachi	3+3	Y	10
114 x 102	80	P-35829	BO4555 BO4554 BO4561: Hitachi	3+3	Y	10
114 x 102	100	P-35835	BO4555 BO4554 BO4561: Hitachi	3+3	Y	10
114 x 102	120	P-35841	BO4555 BO4554 BO4561: Hitachi	3+3	Y	10
114 x 102	150	P-35857	BO4555 BO4554 BO4561: Hitachi	3+3	Y	10
114 x 102	180	P-35863	BO4555 BO4554 BO4561: Hitachi	3+3	Y	10
114 x 102	240	P-35879	BO4555 BO4554 BO4561: Hitachi	3+3	N	10
114 x 102	320	P-35885	BO4555 BO4554 BO4561: Hitachi	3+3	N	10
RED						
80 x 133	40	P-42173	Bosch AEG Milwaukee Festool Hitachi	4+4	Y	10
80 x 133	60	P-42189	Bosch AEG Milwaukee Festool Hitachi	4+4	Y	10
80 x 133	80	P-42195	Bosch AEG Milwaukee Festool Hitachi	4+4	Y	10
80 x 133	120	P-42204	Bosch AEG Milwaukee Festool Hitachi	4+4	Y	10
80 x 133	180	P-42210	Bosch AEG Milwaukee Festool Hitachi	4+4	Y	10
80 x 133	240	P-42226	Bosch AEG Milwaukee Festool Hitachi	4+4	Y	10
80 x 166	40	P-42298	AEG Milwaukee Bosch Stayer	4+4	Y	10
80 x 166	60	P-42307	AEG Milwaukee Bosch Stayer	4+4	Y	10
80 x 166	80	P-42313	AEG Milwaukee Bosch Stayer	4+4	Y	10
80 x 166	120	P-42329	AEG Milwaukee Bosch Stayer	4+4	Y	10
80 x 166	180	P-42335	AEG Milwaukee Bosch Stayer	4+4	Y	10
80 x 166	240	P-42341	AEG Milwaukee Bosch Stayer	4+4	Y	10
114 x 102	40	P-33087	BO4555 BO4554 BO4561: Hitachi	3+3	Y	10
114 x 102	60	P-33093	BO4555 BO4554 BO4561: Hitachi	3+3	Y	10
114 x 102	80	P-33102	BO4555 BO4554 BO4561: Hitachi	3+3	Y	10
114 x 102	100	P-33118	BO4555 BO4554 BO4561: Hitachi	3+3	Y	10
114 x 102	120	P-33124	BO4555 BO4554 BO4561: Hitachi	3+3	Y	10
114 x 102	150	P-33130	BO4555 BO4554 BO4561: Hitachi	3+3	Y	10
114 x 102	180	P-33146	BO4555 BO4554 BO4561: Hitachi	3+3	Y	10
114 x 102	240	P-33152	BO4555 BO4554 BO4561: Hitachi	3+3	Y	10
114 x 102	320	P-33168	BO4555 BO4554 BO4561: Hitachi	3+3	Y	10
114 x 102	40	P-42416	BO4555 BO4554 BO4561: Hitachi	3+3	Y	50
114 x 102	60	P-42422	BO4555 BO4554 BO4561: Hitachi	3+3	Y	50
114 x 102	80	P-42438	BO4555 BO4554 BO4561: Hitachi	3+3	Y	50
114 x 102	100	P-42444	BO4555 BO4554 BO4561: Hitachi	3+3	Y	50
114 x 102	120	P-42450	BO4555 BO4554 BO4561: Hitachi	3+3	Y	50
114 x 102	150	P-42466	BO4555 BO4554 BO4561: Hitachi	3+3	Y	50
114 x 102	180	P-42472	BO4555 BO4554 BO4561: Hitachi	3+3	Y	50
114 x 102	240	P-42488	BO4555 BO4554 BO4561: Hitachi	3+3	Y	50
114 x 102	320	P-42494	BO4555 BO4554 BO4561: Hitachi	3+3	Y	50
WHITE						
114 x 140	40	P-36516	BO4556 BO4553: Bosch B&D DeWalt Ryobi Skil	0	N	10
114 x 140	60	P-36522	BO4556 BO4553: Bosch B&D DeWalt Ryobi Skil	0	N	10
114 x 140	80	P-36538	BO4556 BO4553: Bosch B&D DeWalt Ryobi Skil	0	N	10
114 x 140	100	P-36544	BO4556 BO4553: Bosch B&D DeWalt Ryobi Skil	0	N	10
114 x 140	120	P-36550	BO4556 BO4553: Bosch B&D DeWalt Ryobi Skil	0	N	10
114 x 140	150	P-36566	BO4556 BO4553: Bosch B&D DeWalt Ryobi Skil	0	N	10
114 x 140	180	P-36572	BO4556 BO4553: Bosch B&D DeWalt Ryobi Skil	0	N	10
114 x 140	240	P-36588	BO4556 BO4553: Bosch B&D DeWalt Ryobi Skil	0	N	10
RED						
114 x 140	40	P-36398	BO4556 BO4553: Bosch B&D DeWalt Ryobi Skil	0	N	10
114 x 140	60	P-32904	BO4556 BO4553: Bosch B&D DeWalt Ryobi Skil	0	N	10
114 x 140	80	P-36407	BO4556 BO4553: Bosch B&D DeWalt Ryobi Skil	0	N	10
114 x 140	100	P-32910	BO4556 BO4553: Bosch B&D DeWalt Ryobi Skil	0	N	10
114 x 140	120	P-32926	BO4556 BO4553: Bosch B&D DeWalt Ryobi Skil	0	N	10
114 x 140	150	P-32932	BO4556 BO4553: Bosch B&D DeWalt Ryobi Skil	0	N	10
114 x 140	180	P-36413	BO4556 BO4553: Bosch B&D DeWalt Ryobi Skil	0	N	10
114 x 140	240	P-36429	BO4556 BO4553: Bosch B&D DeWalt Ryobi Skil	0	N	10
114 x 140	40	P-36435	BO4556 BO4553: Bosch B&D DeWalt Ryobi Skil	0	N	50
114 x 140	60	P-36441	BO4556 BO4553: Bosch B&D DeWalt Ryobi Skil	0	N	50
114 x 140	80	P-36457	BO4556 BO4553: Bosch B&D DeWalt Ryobi Skil	0	N	50
114 x 140	100	P-36463	BO4556 BO4553: Bosch B&D DeWalt Ryobi Skil	0	N	50
114 x 140	120	P-36479	BO4556 BO4553: Bosch B&D DeWalt Ryobi Skil	0	N	50
114 x 140	150	P-36485	BO4556 BO4553: Bosch B&D DeWalt Ryobi Skil	0	N	50
114 x 140	180	P-36491	BO4556 BO4553: Bosch B&D DeWalt Ryobi Skil	0	N	50
114 x 140	240	P-36500	BO4556 BO4553: Bosch B&D DeWalt Ryobi Skil	0	N	50

Batteries & Cases
Tool Holders
Drilling
Fixing
Saw Blades
Jigsaw & Recip
Multi Tool
Diamond
Bonded Abrasives
Flap Discs
Coated Abrasives
Router Cutters
Dust Extraction
Ground Maintenance

COATED ABRASIVES: DISCS

VELCRO BACKED ABRASIVE DISCS 6"



< D >

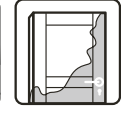
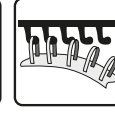
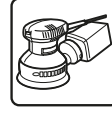

Size mm	Grit	Part No.	Model	Holes	Velcro	Pack
MULTI PURPOSE ABRASIVE - EXTRA LUBRICANT STEARATE GRIT 150mm						
150	40	B-39300	BO6030, BO6040	15	Y	50
150	60	B-39316	BO6030, BO6040	15	Y	50
150	80	B-39322	BO6030, BO6040	15	Y	100
150	100	B-39338	BO6030, BO6040	15	Y	100
150	120	B-39344	BO6030, BO6040	15	Y	100
150	240	B-39350	BO6030, BO6040	15	Y	100
150	320	B-39366	BO6030, BO6040	15	Y	100
150	360	B-39372	BO6030, BO6040	15	Y	100
150	400	B-39388	BO6030, BO6040	15	Y	100
150	500	B-39394	BO6030, BO6040	15	Y	100
150	600	B-39403	BO6030, BO6040	15	Y	100
150	800	B-39419	BO6030, BO6040	15	Y	100
150	1000	B-39425	BO6030, BO6040	15	Y	100
RED 150mm						
150	40	P-37471	BO6030 BO6040: Bosch B&D DeWalt Metabo	6	Y	10
150	60	P-37487	BO6030 BO6040: Bosch B&D DeWalt Metabo	6	Y	10
150	80	P-37493	BO6030 BO6040: Bosch B&D DeWalt Metabo	6	Y	10
150	100	P-37502	BO6030 BO6040: Bosch B&D DeWalt Metabo	6	Y	10
150	120	P-37518	BO6030 BO6040: Bosch B&D DeWalt Metabo	6	Y	10
150	180	P-37524	BO6030 BO6040: Bosch B&D DeWalt Metabo	6	Y	10
150	240	P-37530	BO6030 BO6040: Bosch B&D DeWalt Metabo	6	Y	10
150	320	P-37546	BO6030 BO6040: Bosch B&D DeWalt Metabo	6	Y	10
150	400	P-37552	BO6030 BO6040: Bosch B&D DeWalt Metabo	6	Y	10
150	40	P-37568	BO6030 BO6040: Bosch B&D DeWalt Metabo	6	Y	50
150	60	P-37574	BO6030 BO6040: Bosch B&D DeWalt Metabo	6	Y	50
150	80	P-37580	BO6030 BO6040: Bosch B&D DeWalt Metabo	6	Y	50
150	100	P-37596	BO6030 BO6040: Bosch B&D DeWalt Metabo	6	Y	50
150	120	P-37605	BO6030 BO6040: Bosch B&D DeWalt Metabo	6	Y	50
150	180	P-37611	BO6030 BO6040: Bosch B&D DeWalt Metabo	6	Y	50
150	240	P-37627	BO6030 BO6040: Bosch B&D DeWalt Metabo	6	Y	50
150	320	P-37633	BO6030 BO6040: Bosch B&D DeWalt Metabo	6	Y	50
150	400	P-37649	BO6030 BO6040: Bosch B&D DeWalt Metabo	6	Y	50
150	40	P-31918	BO6030 BO6040: Festool	8+1	Y	10
150	60	P-31924	BO6030 BO6040: Festool	8+1	Y	10
150	80	P-31930	BO6030 BO6040: Festool	8+1	Y	10
150	100	P-31946	BO6030 BO6040: Festool	8+1	Y	10
150	120	P-31952	BO6030 BO6040: Festool	8+1	Y	10
150	150	P-31968	BO6030 BO6040: Festool	8+1	Y	10
150	180	P-31974	BO6030 BO6040: Festool	8+1	Y	10
150	220	P-31980	BO6030 BO6040: Festool	8+1	Y	10
150	240	P-31996	BO6030 BO6040: Festool	8+1	Y	10
150	320	P-32007	BO6030 BO6040: Festool	8+1	Y	10
150	400	P-32013	BO6030 BO6040: Festool	8+1	Y	10
150	40	P-32574	BO6030 BO6040: Festool	8+1	Y	50
150	60	P-32580	BO6030 BO6040: Festool	8+1	Y	50
150	80	P-32596	BO6030 BO6040: Festool	8+1	Y	50
150	100	P-32605	BO6030 BO6040: Festool	8+1	Y	50
150	120	P-32611	BO6030 BO6040: Festool	8+1	Y	50
150	180	P-32633	BO6030 BO6040: Festool	8+1	Y	50
150	240	P-32655	BO6030 BO6040: Festool	8+1	Y	50
150	320	P-32661	BO6030 BO6040: Festool	8+1	Y	50
150	400	P-32677	BO6030 BO6040: Festool	8+1	Y	50
WHITE 150mm						
150	40	P-37655	BO6030 BO6040: Bosch B&D DeWalt Metabo	6	Y	10
150	60	P-37661	BO6030 BO6040: Bosch B&D DeWalt Metabo	6	Y	10
150	80	P-37677	BO6030 BO6040: Bosch B&D DeWalt Metabo	6	Y	10
150	100	P-37683	BO6030 BO6040: Bosch B&D DeWalt Metabo	6	Y	10
150	120	P-37699	BO6030 BO6040: Bosch B&D DeWalt Metabo	6	Y	10
150	180	P-37708	BO6030 BO6040: Bosch B&D DeWalt Metabo	6	Y	10
150	240	P-37714	BO6030 BO6040: Bosch B&D DeWalt Metabo	6	Y	10
150	320	P-37720	BO6030 BO6040: Bosch B&D DeWalt Metabo	6	Y	10
150	400	P-37736	BO6030 BO6040: Bosch B&D DeWalt Metabo	6	Y	10
150	40	P-37839	BO6030 BO6040: Festool	8+1	Y	10
150	60	P-37845	BO6030 BO6040: Festool	8+1	Y	10
150	80	P-37851	BO6030 BO6040: Festool	8+1	Y	10
150	100	P-37867	BO6030 BO6040: Festool	8+1	Y	10
150	120	P-37873	BO6030 BO6040: Festool	8+1	Y	10
150	150	P-37889	BO6030 BO6040: Festool	8+1	Y	10
150	180	P-37895	BO6030 BO6040: Festool	8+1	Y	10
150	220	P-37904	BO6030 BO6040: Festool	8+1	Y	10
150	240	P-37910	BO6030 BO6040: Festool	8+1	Y	10
150	320	P-37926	BO6030 BO6040: Festool	8+1	Y	10
150	400	P-37932	BO6030 BO6040: Festool	8+1	Y	10
WHITE 180mm						
180	40	P-33439	9227CB	0	Y	10
180	60	P-38037	9227CB	0	Y	10
180	80	P-33445	9227CB	0	Y	10
180	100	P-38043	9227CB	0	Y	10
180	120	P-33451	9227CB	0	Y	10
180	240	P-38059	9227CB	0	Y	10
180	320	P-38065	9227CB	0	Y	10
180	360	P-38071	9227CB	0	Y	10
180	400	P-38087	9227CB	0	Y	10
180	500	P-38093	9227CB	0	Y	10

VELCRO BACKED ABRASIVE DISCS 5"



< D >

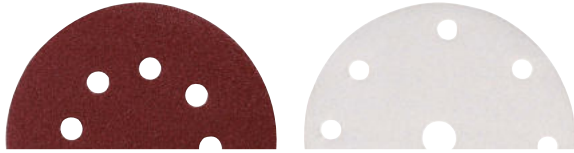

Size mm	Grit	Part No.	Model	Holes	Velcro	Pack
RED						
125	40	P-43533	DBO180/140 BO5010/12/21 BO5030/31/41: Bosch B&D DeWalt Milwaukee Metabo Festool	8	Y	10
125	60	P-43549	DBO180/140 BO5010/12/21 BO5030/31/41: Bosch B&D DeWalt Milwaukee Metabo Festool	8	Y	10
125	80	P-43555	DBO180/140 BO5010/12/21 BO5030/31/41: Bosch B&D DeWalt Milwaukee Metabo Festool	8	Y	10
125	100	P-43561	DBO180/140 BO5010/12/21 BO5030/31/41: Bosch B&D DeWalt Milwaukee Metabo Festool	8	Y	10
125	120	P-43577	DBO180/140 BO5010/12/21 BO5030/31/41: Bosch B&D DeWalt Milwaukee Metabo Festool	8	Y	10
125	180	P-43583	DBO180/140 BO5010/12/21 BO5030/31/41: Bosch B&D DeWalt Milwaukee Metabo Festool	8	Y	10
125	240	P-43599	DBO180/140 BO5010/12/21 BO5030/31/41: Bosch B&D DeWalt Milwaukee Metabo Festool	8	Y	10
125	320	P-43608	DBO180/140 BO5010/12/21 BO5030/31/41: Bosch B&D DeWalt Milwaukee Metabo Festool	8	Y	10
125	400	P-43614	DBO180/140 BO5010/12/21 BO5030/31/41: Bosch B&D DeWalt Milwaukee Metabo Festool	8	Y	10
125	40	P-43620	DBO180/140 BO5010/12/21 BO5030/31/41: Bosch B&D DeWalt Milwaukee Metabo Festool	8	Y	50
125	60	P-43636	DBO180/140 BO5010/12/21 BO5030/31/41: Bosch B&D DeWalt Milwaukee Metabo Festool	8	Y	50
125	80	P-43642	DBO180/140 BO5010/12/21 BO5030/31/41: Bosch B&D DeWalt Milwaukee Metabo Festool	8	Y	50
125	100	P-43658	DBO180/140 BO5010/12/21 BO5030/31/41: Bosch B&D DeWalt Milwaukee Metabo Festool	8	Y	50
125	120	P-43664	DBO180/140 BO5010/12/21 BO5030/31/41: Bosch B&D DeWalt Milwaukee Metabo Festool	8	Y	50
125	180	P-43670	DBO180/140 BO5010/12/21 BO5030/31/41: Bosch B&D DeWalt Milwaukee Metabo Festool	8	Y	50
125	240	P-43686	DBO180/140 BO5010/12/21 BO5030/31/41: Bosch B&D DeWalt Milwaukee Metabo Festool	8	Y	50
125	320	P-43692	DBO180/140 BO5010/12/21 BO5030/31/41: Bosch B&D DeWalt Milwaukee Metabo Festool	8	Y	50
125	400	P-43701	DBO180/140 BO5010/12/21 BO5030/31/41: Bosch B&D DeWalt Milwaukee Metabo Festool	8	Y	50
WHITE						
125	40	P-33342	DBO180/140 BO5010/12/21 BO5030/31/41: Bosch B&D DeWalt Milwaukee Metabo Festool	8	Y	10
125	60	P-33358	DBO180/140 BO5010/12/21 BO5030/31/41: Bosch B&D DeWalt Milwaukee Metabo Festool	8	Y	10
125	80	P-33364	DBO180/140 BO5010/12/21 BO5030/31/41: Bosch B&D DeWalt Milwaukee Metabo Festool	8	Y	10
125	100	P-33370	DBO180/140 BO5010/12/21 BO5030/31/41: Bosch B&D DeWalt Milwaukee Metabo Festool	8	Y	10
125	120	P-33386	DBO180/140 BO5010/12/21 BO5030/31/41: Bosch B&D DeWalt Milwaukee Metabo Festool	8	Y	10
125	180	P-33392	DBO180/140 BO5010/12/21 BO5030/31/41: Bosch B&D DeWalt Milwaukee Metabo Festool	8	Y	10
125	240	P-33401	DBO180/140 BO5010/12/21 BO5030/31/41: Bosch B&D DeWalt Milwaukee Metabo Festool	8	Y	10
125	320	P-33417	DBO180/140 BO5010/12/21 BO5030/31/41: Bosch B&D DeWalt Milwaukee Metabo Festool	8	Y	10
125	400	P-33423	DBO180/140 BO5010/12/21 BO5030/31/41: Bosch B&D DeWalt Milwaukee Metabo Festool	8	Y	10

VELCRO BACKED ABRASIVE DISCS 5" FOR PAINT



< D >

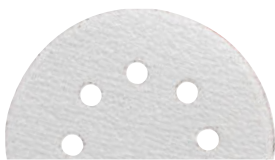

Size mm	Grit	Part No.	Model	Holes	Velcro	Pack
WHITE						
125	40	D-65816	DB0180/140 BO5030/31/41 : Bosch B&D DeWalt Milwaukee Metabo Festool	8	Y	10
125	60	D-65822	DB0180/140 BO5030/31/41 : Bosch B&D DeWalt Milwaukee Metabo Festool	8	Y	10
125	80	D-65838	DB0180/140 BO5030/31/41 : Bosch B&D DeWalt Milwaukee Metabo Festool	8	Y	10
125	100	D-65844	DB0180/140 BO5030/31/41 : Bosch B&D DeWalt Milwaukee Metabo Festool	8	Y	10
125	120	D-65850	DB0180/140 BO5030/31/41 : Bosch B&D DeWalt Milwaukee Metabo Festool	8	Y	10
125	150	D-65866	DB0180/140 BO5030/31/41 : Bosch B&D DeWalt Milwaukee Metabo Festool	8	Y	10
125	180	D-65872	DB0180/140 BO5030/31/41 : Bosch B&D DeWalt Milwaukee Metabo Festool	8	Y	10
125	240	D-65888	DB0180/140 BO5030/31/41 : Bosch B&D DeWalt Milwaukee Metabo Festool	8	Y	10
125	320	D-65894	DB0180/140 BO5030/31/41 : Bosch B&D DeWalt Milwaukee Metabo Festool	8	Y	10
125	400	D-65903	DB0180/140 BO5030/31/41 : Bosch B&D DeWalt Milwaukee Metabo Festool	8	Y	10

VELCRO BACKED ABRASIVE DISCS 9"



< D >



Size mm	Grit	Part No.	Model	Holes	Velcro	Pack
RED						
225	40	B-68389	DSL800	8+1	Y	25
225	80	B-68395	DSL800	8+1	Y	25
225	120	B-68404	DSL800	8+1	Y	25
225	180	B-68410	DSL800	8+1	Y	25
225	320	B-68426	DSL800	8+1	Y	25

Batteries & Cases
Tool Holders
Drilling
Fixing
Saw Blades
Jigsaw & Recip
Multi Tool
Diamond
Bonded Abrasives
Flap Discs
Coated Abrasives
Router Cutters
Dust Extraction
Ground Maintenance

COATED ABRASIVES: FLOOR SANDING, POLISHING

OTHER COATED ABRASIVES - SANDING ROLLS



Size mm	Grit	Part No.	Model	Holes	Velcro	Pack
5m						
115	40	P-38102	5m	0	N	1
120	60	P-38118	5m	0	N	1
120	80	P-38124	5m	0	N	1
120	100	P-38130	5m	0	N	1
120	120	P-38146	5m	0	N	1
120	180	P-38152	5m	0	N	1
120	240	P-38168	5m	0	N	1
120	320	P-38174	5m	0	N	1
120	400	P-38180	5m	0	N	1
50m						
120	40	P-38196	50m	0	N	1
120	60	P-38205	50m	0	N	1
120	80	P-38211	50m	0	N	1
120	100	P-38227	50m	0	N	1
120	120	P-38233	50m	0	N	1
120	180	P-38249	50m	0	N	1
120	240	P-38255	50m	0	N	1
120	320	P-38261	50m	0	N	1
120	400	P-38277	50m	0	N	1

FLOOR SANDER SHEETS



Size mm	Grit	Part No.	Model	Holes	Velcro	Pack
203 x 476	24	P-43717	Clarke EZ-8, Hireteck HT8-1	0	N	25
203 x 476	36	P-43723	Clarke EZ-8, Hireteck HT8-1	0	N	25
203 x 476	40	P-43739	Clarke EZ-8, Hireteck HT8-1	0	N	25
203 x 476	50	P-43745	Clarke EZ-8, Hireteck HT8-1	0	N	25
203 x 476	60	P-43751	Clarke EZ-8, Hireteck HT8-1	0	N	25
203 x 476	80	P-43767	Clarke EZ-8, Hireteck HT8-1	0	N	25
203 x 476	100	P-43773	Clarke EZ-8, Hireteck HT8-1	0	N	25
203 x 476	120	P-43789	Clarke EZ-8, Hireteck HT8-1	0	N	25
203 x 476	150	P-43795	Clarke EZ-8, Hireteck HT8-1	0	N	25

FLOOR SANDING DISCS - EDGING SANDERS



Size mm	Grit	Part No.	Model	Holes	Velcro	Pack
180	24	P-43804	Clarke BZ, Hiretech HT 7-1	1	N	25
180	36	P-43810	Clarke BZ, Hiretech HT 7-1	1	N	25
180	40	P-43826	Clarke BZ, Hiretech HT 7-1	1	N	25
180	50	P-43832	Clarke BZ, Hiretech HT 7-1	1	N	25
180	60	P-43848	Clarke BZ, Hiretech HT 7-1	1	N	25
180	80	P-43854	Clarke BZ, Hiretech HT 7-1	1	N	25
180	100	P-43860	Clarke BZ, Hiretech HT 7-1	1	N	25
180	120	P-43876	Clarke BZ, Hiretech HT 7-1	1	N	25
180	150	P-43882	Clarke BZ, Hiretech HT 7-1	1	N	25

ACCESSORIES FOR DPO500 & DPO600



Part No.	Details	D mm	Pack
197922-4	Backing Pad hook & loop	125	1
197928-2	Backing Pad hook & loop	150	1
197914-3	Sponge Pad	150	1
197895-1	Felt Pad hook & loop	100	1
196152-4	Felt Pad	125	1
193288-0	Felt Pad	150	1
198043-5	Side Grip		1



198043-5

Part No.	Details	Model	D mm	Pack
----------	---------	-------	------	------

PLATES, STEEL, CARBON AND PUNCH PLATES



Steel Plate



Punch Plate

STEEL PLATE				
342328-3	Stone and plastics	9401, 9402, 9403		1
342466-1	Stone and plastics	9900B		1
344586-7	Stone and plastics	9911		1
343355-3	Stone and plastics	9901		1
CARBON PLATE				
423029-3	Wood and Steel	9401, 9402		1
423036-6	Wood and Steel	9924DB		1
423027-7	Wood and Steel	9900B		1
423316-0	Wood and Steel	9920		1
193201-8	Wood and Steel	9404		1
193197-3	Wood and Steel	9902, 9903		1
424057-1	Wood and Steel	9403		1
CORK PAD				
424058-9	Use with steel plate	9401, 9402		1
423035-8		9924DB		1
423313-6		9920		1
193202-6		9404		1
193199-9		9920, 9903		1
PUNCH PLATES				
413094-0		BO4553, BO4554		1
163292-3		9036		1
192523-3		9046, BO4900		1
192989-7		BO3700		1

STANDS AND SHOES



Inversion Stand



Sanding Shoe Set

INVERSION STAND				
342332-2		9401, 9402		1
193055-3		9409, 9903, 9920		1
SANDING SHOE SET				
193070-7		9902, 9903		1
193072-3		9404		1

BELT SANDER 9032 ACCESSORIES



125157-7	6mm arms	9032		1
125158-5	9mm arms	9032		1
125159-3	13mm arms	9032		1

DSL800 ACCESSORIES



199937-7	Extension handle	DLS800		1
----------	------------------	--------	--	---

WOOL BONNET



< D >

794176-0	Wool	9217SPC, 9207SPB	180	1
192629-7	Wool, hook and loop	9227CB	180	1
P-21755	Wool, tie type	9227CB	225	1
199424-6	Wool Pad		150	1
794560-9	Wool	BO5031/41	140	1
794173-6	Wool bonnet		100	1
123001-2	Rubber pad assembly		98	1
794159-0	Wax buffer - Spindle		125	1
D-70873	Wool bonnet coarse		230	1
D-70889	Wool bonnet fine		230	1
D-70867	Wool bonnet		125	1

SPONGES WITH VELCRO



P-21749	Universal, orange	9227CB	150	1
P-21727	Compounding, white	9227CB	150	1
P-21733	Polishing, blue	9227CB	150	1
794558-6	Yellow, white	PO5000/PO6050	125	1

RUBBER BACKING PAD



< D >

P-21777	Rubber pad	For Sponges	M14	1
P-34469	Cushion pad	BO6030, BO6040	150	1
743012-7	Rubber pad*	9227CB	170	1
743053-3	Hook and loop	9227CB	165	1
196684-1	Hard coarse sanding	BO6030/40	150	1
196685-9	Mid general sanding	BO6030/40	150	1
196686-7	Super fine sanding	BO6030/40	150	1
197314-7		BO6050	150	1
197317-1		BO6050	130	1
193521-0		BO4900	115	1
P-34453	Pad multi-hole 8mm	BO6030	150	1

*use with 224515-5 sanding lock nut

WHEEL SANDER ACCESSORIES



794381-9	Cotton buff wheel	9741	Polishing	1
794382-7	Wire brush wheel	9741	Rust	1
P-65648	Brass wheel	9741	Paint	1
P-04416	Satin finish wheel	9741	Dressing	1
P-04422	Nylon brush wheel	9741	60G	1
P-04444	Nylon brush wheel	9741	120G	1
P-04450	Nylon brush wheel	9741	180G	1

Batteries & Cases
Tool Holders
Drilling
Fixing
Saw Blades
Jigsaw & Recip
Multi Tool
Diamond
Bonded Abrasives
Flap Discs
Coated Abrasives
Router Cutters
Dust Extraction
Ground Maintenance

Router Cutters

Makita's range of tungsten carbide tipped and solid carbide router bits aims to provide the market with the most popular styles for home and industrial use, manufactured to Industrial Quality standards. These router bits, under most conditions, will significantly out perform competitors products.



PRO WORKER

Makita's proworker router cutter range of TCT and solid carbide cutters aims to provide the market with the 30 best selling cutters for home and industrial use.

What makes our router cutters great.

- All double flute cutters have safe plunging centre points; loading tests show cutters without this feature require 3 times more downward pressure.
- Cutters are specially relieved for clearance and strength.
- The finest British steels and many special grades of carbide are used in the construction of our router bits.
- High tolerance grinding for superior cutting performances.

STRAIGHT DOUBLE FLUTE TCT

PRO WORKER

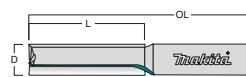

24,000 rpm. Plunging. BG-Test 145-002

Natural & man-made timbers, and plastics. This range of Router Cutters can be used for profiling, edging, grooving, slotting, rebating and recessing into a wide variety of different materials. A hallmark range of Router Cutters combining quality, strength and performance. They have been developed using tungsten carbides to give each cutter increased longevity.

Part No.	D mm	OL mm	L mm	Shank
P-77300	12	70	20	6.35 (1/4")
P-77316	12	115	54	12.7 (1/2")
P-77322	12	115	65	12.7 (1/2")
P-77344	12.7	54	50.8	12.7 (1/2")
P-77338	12.7	95	50.8	12.7 (1/2")
P-77350	12.7	108	63.5	12.7 (1/2")
STRAIGHT DOUBLE FLUTE TCT 10 PACK				
P-77338-10	12.7	95	50.8	12.7 (1/2")
STRAIGHT DOUBLE FLUTE TCT 30 PACK				
P-77338-30	12.7	95	50.8	12.7 (1/2")

PROFILE GUIDE TCT

PRO WORKER

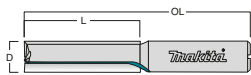

24,000 rpm

Natural & man-made timbers, and plastics. This Router Cutter can be used for profiling, edging, grooving, slotting, rebating and recessing into a wide variety of different materials. This Cutter is also ideal for blind profiling and plunging i.e. double skinned plywood. They also have bearing guides which are designed to run off a top mounted template. Replacement bearings available for purchase.

Part No.	D mm	OL mm	L mm	Shank
P-77419	19	104.5	50	12.7 (1/2")

DOUBLE GUIDE TRIMMER TCT 90

PRO WORKER



24,000 rpm

Natural & man-made timbers, and plastics. This Router Cutter has bearings mounted on both the shank and on the bottom of the spigot. The double bearings prevent the tendency to wander on heavier cuts. Replacement bearings available for purchase.

Part No.	D mm	OL mm	L mm	Shank
P-77403	19	109.95	50	12.7 (1/2")

PROFILE GUIDE TCT 90

PRO WORKER



24,000 rpm. Plunging. BG-Test 145-001

Natural & man-made timbers, and plastics. These Router Cutters are ideal for blind profiling and plunging i.e. double skinned plywood. They also have bearing guides which are designed to run off a top mounted template. Replacement bearings available for purchase.

Part No.	D mm	OL mm	L mm	Shank
P-77279	12.7	71	25	6.35 (1/4")
P-77394	16	66	20	6.35 (1/4")

STRAIGHT TCT

PRO WORKER

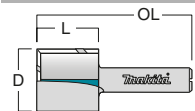

24,000 rpm. Plunging. BG-Test 145-002

Natural & man-made timbers, and plastics. This range of Straight Router Cutters can be used for profiling, edging, grooving, slotting, rebating and recessing into a wide variety of different materials.

Part No.	D mm	OL mm	L mm	Shank
P-77481	3	42	10	6.35 (1/4")
P-77497	4	42	10	6.35 (1/4")
P-77506	5	50.5	10	6.35 (1/4")
P-77512	6	51	10	6.35 (1/4")
P-77528	8	52	20	6.35 (1/4")
P-77534	10	52	20	6.35 (1/4")
P-77291	12	52	20	6.35 (1/4")
P-77263	15	52	20	6.35 (1/4")
P-77372	16	52	20	6.35 (1/4")

BEARING GUIDE EDGE TCT

PRO WORKER

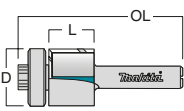

24,000 rpm. Plunging. BG-Test 145-002

Natural & man-made timbers, and plastics. This range of Router Cutters can be used for profiling, edging, grooving, slotting, rebating and recessing into a wide range of materials.

Part No.	D mm	OL mm	L mm	Shank
P-77475	6.3	55.2	12.7	6.35 (1/4")
P-77469	9.5	64.5	25	6.35 (1/4")
P-77257	12.7	63	25	6.35 (1/4")
P-77366	19	50.7	12.7	6.35 (1/4")

BEARING GUIDE EDGE TRIMMER TCT

PRO WORKER

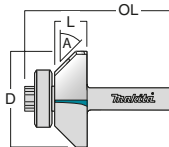

24,000 rpm. Plunging. BG-Test 145-002

Plastics and laminates. Ideal for bevelling and trimming formicas and laminates. A = 45°

Part No.	D mm	OL mm	L mm	Shank
P-77453	27	47	9	6.35 (1/4")

GUTTERING TCT

PRO WORKER

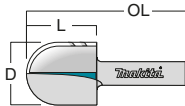

24,000 rpm. Plunging. BG-Test 145-002

Natural & man-made timbers, and plastics. Ideal for veining work, free hand decor for panels, useful for character lining on sign writing applications in solid timbers.

Part No.	D mm	OL mm	L mm	Shank
P-77388	20	44	16	6.35 (1/4")

GROOVING TCT

PRO WORKER

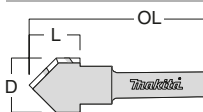

24,000 rpm. Plunging. BG-Test 145-002

Natural & man-made timbers, and plastics. Ideal for veining work, free hand decor for panels, useful for character lining on sign writing applications in solid timbers. A = 45°

Part No.	D mm	OL mm	L mm	Shank
P-77285	12.7	47.35	5	6.35 (1/4")

REBATE TCT

PRO WORKER

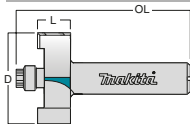

24,000 rpm. Plunging. BG-Test 145-002

Natural & man-made timbers. Rebate cutter with 9.5mm diameter bearing. Three further sized bearings also available for purchase. Diameter: 12.7mm, 16mm, 19mm.

Part No.	D mm	OL mm	L mm	Shank
P-77447	35	52.7	12.7	6.35 (1/4")

BISCUIT JOINTER TCT

PRO WORKER

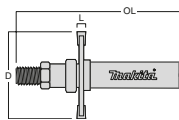

24,000 rpm. Plunging. BG-Test 145-001

Natural & man-made timbers, and plastics. Designed to allow Biscuit Joint Slots to be machined into chipboard, MDF, and solid timbers using a hand-held routing machine. Three different sized bearings available.

Part No.	D mm	OL mm	L mm	Shank
P-77241	38	50.5	4	6.35 (1/4")

ROUNDING OVER TCT

PRO WORKER

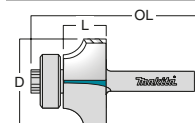

24,000 rpm. Plunging. BG-Test 145-001

Natural & man-made timbers, and plastics. Designed to allow Biscuit Joint Slots to be machined into chipboard, MDF, and solid timbers using a hand-held routing machine. Three different sized bearings available.

Part No.	D mm	OL mm	L mm	Shank
P-77425	25.4	49.2	12.7	6.35 (1/4")
P-77431	31.7	52.7	31.7	6.35 (1/4")

ROUTER CUTTERS *********

STRAIGHT DOUBLE FLUTE TCT

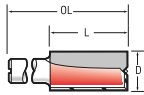

24,000 rpm. Plunging. BG-Test 145-002

A range of metric diameter cutters with plunging centre point on the larger diameters. For general routing application.

Part No.	D mm	OL mm	L mm	Shank
P-54237	2	39	6.5	1/4"
P-54243	2.5	40	8	1/4"
P-54259	3	42	10	1/4"
P-54265	4	42	10	1/4"
P-54271	5	48	16	1/4"
P-54287	6	48	16	1/4"
P-54293	6	65	25	1/2"
P-54302	6.3	48	16	1/4"
P-54318	6.3	57	25	1/4"
P-54324	7	48	16	1/4"
P-54330	8	52	20	1/4"
P-54346	8	65	25	1/2"
P-54352	9	52	20	1/4"
P-54368	9	57	25	1/2"
P-54374	10	52	20	1/4"
P-54380	10	65	25	1/2"
P-54396	10	75	35	1/2"
P-54405	11	57	25	1/4"
P-54411	12	52	20	1/4"
P-54427	12	65	25	1/2"
P-54433	12	95	50	1/2"
P-54455	14	52	20	1/4"
P-54461	14	65	25	1/2"
P-54477	15	57	25	1/4"
P-54483	16	52	20	1/4"
P-54499	16	65	25	1/2"
P-54514	17	65	25	1/2"
P-54520	18	65	25	1/2"
P-54536	18	95	50	1/2"
P-54542	19	65	25	1/2"
P-54558	20	52	20	1/4"
P-54564	20	65	25	1/2"
P-54570	22	65	25	1/2"
P-54586	25	65	25	1/2"
P-54592	30	65	25	1/2"
P-54601	12.7	84	50	1/2"
P-54617	12.7	99	50	1/2"
P-54623	12.7	108	63	1/2"
P-54639	15.9	105	63	1/2"

REPLACEMENT TIP SINGLE FLUTE TCT

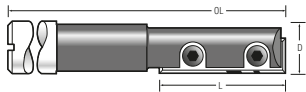

Part No.	D mm	OL mm	L mm	Cut Depth	Shank	Pack
P-55706	12.7	108	30	50	1/2"	1
P-55712	12.7	100	50	50	1/2"	1
REPLACEMENT BLADES						
P-56867-10	9	30				10
P-56873-10	9	50				10

STRAIGHT SINGLE FLUTE TCT

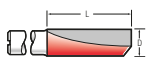

24,000 rpm. Plunging.

A range of small diameter single flute cutters for fast free cutting of apertures and shaping work. The single flute provides greater strength and extra clearance.

Part No.	D mm	OL mm	L mm	Shank
P-55728	2	37	5	1/4"
P-55734	2.5	42	10	1/4"
P-55740	3	42	10	1/4"
P-55756	4	42	10	1/4"
P-55762	5	55	20	1/4"
P-55778	6	55	20	1/4"
P-55784	7	55	20	1/4"

PROFILE GUIDE WITH TOP BEARING TCT

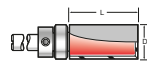

24,000 rpm. Plunging. BG-Test 145-002

This range of cutters are made with plunging centre points, ideal for blind profiling and plunging. They also have Bearing Guides which are designed to run off a top mounted template.

Part No.	D mm	OL mm	L mm	Shank
P-54726	12.7	9.5	47	1/4"
P-54732	12.7	25.4	61	1/4"
P-54748	16	25	60	1/4"
P-54754	19	50	95	1/2"
P-56091	12.7	19	55	1/4"
P-56100	12.7	32	68	1/4"
P-56116	19	25	70	1/2"
P-56122	25	25	70	1/2"

HINGE RECESSORS DOUBLE FLUTE TCT

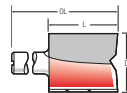

24,000 rpm. Plunging.

A cutter ideal for hinge recessing or the recessing of the underside of handrails.

Part No.	D mm	OL mm	L mm	Shank
P-54673	10	51	19	1/4"
P-54695	12	66	20	1/4"

P-54673 and P-54689 are designed for the cutting of fire proofing strips. P-54695 has a 45mm shank length to suit hinge jig.

STRAIGHT LONG REACH DOUBLE FLUTE TCT

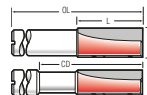

24,000 rpm. Plunging. BG-Test 145-001

This range of metric diameter cutters have a relieved neck behind the tip for deep slotting.

Part No.	D mm	L mm	CD mm	OL mm	Shank
P-55790	6.35	19	37	70	1/4"
P-55809	6.35	19	50	83	1/4"
P-55815	8	19	37	70	1/4"
P-55821	9.5	19	50	83	3/8"
P-55837	12.7	32	50	96	1/2"
P-55843	12.7	32	63	105	1/2"
P-55859	16	32	50	96	1/2"
P-55865	16	32	75	121	1/2"
P-55871	19	32	50	93	1/2"
P-55887	19	32	75	121	1/2"

HELICAL ACRYLIC DOUBLE FLUTE TCT

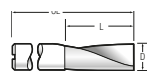

24,000 rpm. Plunging.

The accepted solid carbide cutter for machining and routing acrylics, plastic and perspex.

Part No.	D mm	OL mm	L mm	Shank
P-54645	3	12	57	1/4"
P-54651	4	14	57	1/4"
P-54667	6.35	19	57	1/4"

The helical cut gives a much easier lead into the material preventing snatching and chipping on cut. Perfect preparation before flame polishing of Perspex.

UNIVERSAL COUNTERSINK TCT



6,000 rpm. Plunging.

This countersink enables drills between 3mm and 7.2mm to be used for various screw sizes. The cutter body clamps onto the allen screws.

Part No.	D mm	L mm
P-55697	12	34

TRIMMERS BEARING GUIDE TCT

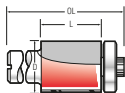

24,000 rpm. Plunging. BG-Test 145-002

A range of trimmers with a bottom bearing for the cutting of Formica and laminated tops.

Part No.	D mm	OL mm	L mm	Shank
P-54760	18	59	12	1/4"
P-54776	18	69	25	1/4"
P-54782	18	103	50	1/2"
P-54829	6.3	57	12.7	1/4"
P-54835	6.3	70	25	1/4"
P-54841	12.7	58	16	1/4"
P-54857	12.7	68	25	1/4"
TRIPLE FLUTE				
P-54798	12.7	72	25	1/4"
P-54807	12.7	98	38	1/2"

CHAMFERED TRIMMERS WITH BEARING TCT

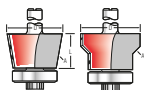

24,000 rpm. Plunging. BG-Test 145-001

Part No.	D mm	OL mm	L mm	A	Shank
P-56138	27	56	9	45°	1/4"
P-54891	57	80	27	45°	1/2"
P-56144	28	56	12	60°	1/4"
P-56166	27	55	9	30°	1/4"
P-56150	24	59	15	45°, 90°	1/4"

OVOLO/ROUNDING OVER TCT



24,000 rpm. Plunging. BG-Test 145-001

Used in conjunction with a side fence, most ovolo and rounding over operations can be produced with this extensive range. These cutters have plunging facility.

Part No.	D mm	L mm	d mm	R mm	Shank
P-54966	17	3	11	3	1/4"
P-54972	19	4	11	4	1/4"
P-54988	21	5	11	5	1/4"
P-54994	23	6.3	11	6.3	1/4"
P-55005	27	8	11	8	1/4"
P-55011	31	10	11	10	1/2"
P-55027	35	12	11	12	1/2"

ROUNDING OVER WITH BEARING TCT



24,000 rpm. Non plunging. BG-Test 145-001

Two shapes produced with one cutter by changing the bearing. B16 bearing removes the quirk.

Part No.	D mm	OL mm	L mm	R mm	Shank
P-55033	20	52	8	2	1/4
P-55049	22	54	10	3	1/4
P-55055	24	54	10	4	1/4
P-55061	26	55	11	5	1/4
P-55077	28	55	12	6	1/4
P-55083	32	58	15	8	1/4
P-55099	35	59	15.8	9.5	1/4
P-55108	41	72	19	12.7	1/2

STAFF/CORNER BEAD WITH BEARING TCT



24,000 rpm. Plunging. BG-Test 145-001

These cutters are the perfect solution to finishing cladding and corners on pillar covering or for enhancing square table legs or returns on wall unit furniture.

Part No.	D mm	OL mm	L mm	R mm	Shank
P-55594	20	55	12	2	1/4"
P-55603	22	56	14	3.2	1/4"
P-55619	27	59	16	4.8	1/4"
P-55625	28.7	66	21	6.3	1/4"

BARLEY TWIST TCT

Part No.	D mm	L1 mm	L2 mm	L3 mm	R1 mm	R2 mm	Shank
P-55647	44	22	2	18			1/2"
P-55653	41.5	16.5	8.5	19	11		1/2"

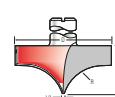

18,000 rpm. Plunging. BG-Test 145-001

This ovolo cutter is a deeper version of P-55631. It can be used for engraving when used with a CNC router machine.

P-55647	44	22	2	18			1/2"
---------	----	----	---	----	--	--	------

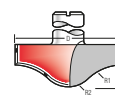

18,000 rpm. Plunging. BG-Test 145-001

This cutter can be used for creating 'roping' effects and fluting, as well as panel raising.

P-55653	41.5	16.5	8.5	19	11		1/2"
---------	------	------	-----	----	----	--	------

RADIUS/GUTTERING TCT

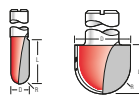

24,000 rpm. Plunging. BG-Test 145-001

Single Flute: Half round cutters for applications such as chalk grooves in desktops. Double Flute: Creates most ovolo and rounding over operations with side fence.

Part No.	D mm	OL mm	L mm	R mm	Shank
SINGLE FLUTE					
P-55186	3.2	43	9.5	1.6	1/4"
P-55192	6	51	16	3	1/4"
DOUBLE FLUTE					
P-55120	10	50	16	5	1/4"
P-55142	16	50	18	8	1/4"
P-55158	18	50	18	9	1/4"
P-55164	20	50	18	10	1/2"
P-55114	8		18		1/4"
P-55136	12.7		17		1/4"
P-55170	25		18		1/2"

STAFF / BULL NOSE TCT

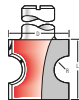

24,000 rpm. Plunging. BG-Test 145-001

A range for producing bull nosings and edgings.

Part No.	D mm	L mm	R mm	OL mm	Shank
P-55566	25	58	25	6	1/4"
P-55572	29	69	28	8	1/2"
P-55588	33	75	34	10	1/2"

BISCUIT JOINTER TCT

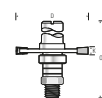

NMAX 12,000

Designed to allow biscuit joint slots to be a machined with a hand held router, supplied with 3 bearings: 15mm, 19mm, 23mm diameter

Part No.	D mm	K mm	OL mm	Shank
P-55669	40	55	4	1/4
P-55677	40	55	4	1/2

ROUTER CUTTERS *********

PLUNGE AND TRIM TCT

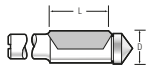

24,000 rpm. Plunging. BG-Test 145-001

A very popular cutter with caravan manufacturers. Used for cutting apertures and openings in caravan sections.

Part No.	D mm	L mm	Flutes	Shank
P-56275	6.3	20	1	1/4"
P-56281	9.5	25	1	3/8"
P-56297	9.5	25	2	3/8"
P-56306	12.7	25	1	1/2"
P-56312	12.7	25	2	1/2"

REBATE WITH BEARING TCT

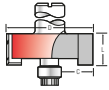

24,000 rpm. Plunging. BG-Test 145-002

By changing the bearings supplied with this cutter, four different rebate depths are possible. Bearing diameters supplied are: 9.5, 12.7, 16 and 19 mm.

Part No.	D mm	L mm	Shank Length	OL mm	Shank
P-54704	35	12.7	40	19	1/4"
P-54710	35	12.7	60	19	1/2"

CHAMFER HEAVY DUTY TCT

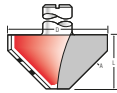

24,000 rpm. Non plunging. BG-Test 145-002

The heavy duty cutter for chamfering work. These cutters have a bottom cut facility.

Part No.	D mm	OL mm	L mm	A	Shank
P-54879	41	63	22	45°	1/2"
P-54885	57	69	27	45°	1/2"

CHAMFER WITH GUIDE PIN TCT



24,000 rpm. Non plunging. BG-Test 145-002

For bevelling small sheet material. Useful for internal work where the small diameter pin enables right angle corners to be machined. Pin diameter - 5.5mm.

Part No.	D mm	OL mm	L mm	A	Shank
P-54863	25	53	16	45°	1/4"

V-GROOVING AND ENGRAVING TCT



24,000 rpm. Non plunging. BG-Test 145-002

Ideal for veining work, free hand decor for panels, useful for character lining work on sign writing applications in solid and composite woods.

Part No.	D mm	L mm	C mm	A	Flutes	Shank
P-54900	16	16	14	60°	2	1/4"
P-54916	26	21	32	60°	1	1/2"
P-54922	18	14	13	45°	2	1/4"
P-54938	30	19	20	45°	2	1/2"
P-54944	44	21	32	45°	1	1/2"
P-54950	12.7	12	15	60°	3	1/4"

STAIRHOUSING DOVETAILS TCT



24,000 rpm. Plunging. BG-Test 145-002

Used in overhead routers with stair stringing jigs. These right hand rotation cutters have a plunging facility. Standard angle - 5°.

Part No.	D mm	L mm	OL mm	Shank
P-56253	14	18	60	1/2"
P-56269	16	18	60	1/2"
P-56219	16	25.4	67	1/2"
P-56225	19	25.4	67	1/2"
P-56231	22	25.4	67	1/2"
P-56247	25.4	25.4	67	1/2"

DOVETAIL TCT



24,000 rpm. Plunging. BG-Test 145-002

Standard sizes for all dovetail applications such as, slot dovetail, hidden dovetail etc.

Part No.	D mm	OL mm	L mm	A	Shank
P-55295	10	43	9	10°	1/4"
P-55304	12	45	10	10°	1/4"
P-55310	14	43	14	10°	1/4"

ROMAN OGEE WITH BEARING TCT

Part No.	D mm	d mm	L mm	R mm	Shank
----------	------	------	------	------	-------



24,000 rpm. Non plunging. BG-Test 145-001

Classic Roman Ogee used in any work needing a quality finish.

P-55441	28.5		12.7	4	1/4"
P-55457	38.2		19	6.3	1/2"



24,000 rpm. Non plunging. BG-Test 145-001

Classic Corecutter

P-55463	30	13	16	5	1/4"
P-55479	37	16	16	8	1/4"

HINGE SINKERS TCT

Part No.	D mm	OL mm	Shank
----------	------	-------	-------

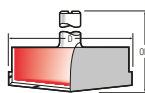

6,000 rpm. Plunging. BG-Test 145-001

For producing hinge holes in laminated boards.

P-55675	35	47	1/4"
---------	----	----	------



6,000 rpm. Plunging.

This cutter has scribers, ideal for use on veneers and wood. Not designed for portable router

P-55681	35	65	1/4"
---------	----	----	------

ROUTER CUTTERS / ROUTER: JIGS

12PC ROUTER SET

A-91051

- Round over:** D: 22.2mm / R: 6.3mm
- Cove:** D: 22mm / R: 6.3mm
- Dovetail:** D: 22.7mm / A: 14°
- Chamfer:** D: 32mm / A: 45°
- Rabbeting:** D: 12.7mm
- Dado:** D: 22.7mm
- Round nose:** D: 12.7mm / R: 6.35mm
- Dado:** D: 15.88mm
- Dado:** D: 6.35mm
- Round over:** D: 28.6mm / R: 9.5mm
- V-groove:** D: 12.7mm / A: 90°
- Roman Ogee:** D: 25mm / R: 4mm
- Shank:** 1/4"



Complete in wooden box with felt lining.
Cutting guide illustrations included.



4PC ROUTER SET

P-24876

Solid carbide router bits.
Manufactured under controlled conditions to ensure industrial quality standards.

Set Contains:
3 x Straight Bits: 1/4", 3/8", 3/4"

1 x Round Bit: 1/4"

Shank: 1/4"



HIRE JIG



Fixed pins and replaceable insert perfect for hire use.

Part No.	Details	Size
P-64048	Hire Jig with Insert and Bag	700mm
P-65741	Fixed pin	
P-65757	Movable pin	

REPLACEMENT INSERT

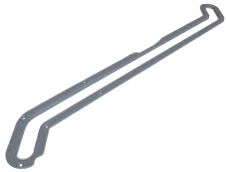

Fixed pins and replaceable insert perfect for hire use.

P-64191	Insert for hire jig P-64048	
---------	-----------------------------	--

ADJUSTABLE HINGE AND FRAME JIG



The adjustable hinge and frame jig will accommodate up to 4 hinges ranging from 50mm-127mm x 6.5mm-35mm. The jig can be used for both door and frame without additional adjustment.

P-64244	Adjustable hinge & frame jig	
---------	------------------------------	--

STANDARD WORKTOP JIG 1000MM



Easy carry handle. For 90° and 45° male and female cuts. apertures for 150mm and 65mm worktop connectors. complete with carry bag.

P-64200	Worktop Jig	1000mm
P-65763	Pin pack	

STANDARD WORKTOP JIG 700MM



for 90° and 45°. male and female cuts. Apertures for 150mm and 65mm worktop connectors. Complete with carry bag.

P-63993	Standard Worktop Jig	700mm
P-65763	Pin pack	

ROUTER: JIGS, BASES

Part No.	Details	Size
----------	---------	------

OUT OF SQUARE WORKTOP JIG



Achieve faultless worktop joints even in out of square applications from -5° to $+5^{\circ}$. Fully adjustable and complete with carry bag.

P-64004	Out of Square Worktop Jig	700mm
P-65735	Adjustable Plate Replacement	

LOCK JIG



A quick and easy setup allows you to accurately cut apertures for a mortise lock and face plate. Quick change inserts allow the jig to be used for the most popular sizes of lock. Adjusting to the centre line of the door, the jig can be used for doors from 20mm – 70mm thick. Supplied with all templates.

P-64238	Lock Jig	70mm
P-65698	Template A	
P-65707	Template B	
P-65713	Template C	
P-65729	Template D	

UNIVERSAL JIG BAG



Jigs up to 700mm

P-64026	Bag for 700mm Jig	700mm
---------	-------------------	-------

UNIVERSAL JIG BAG



Jigs up to 1000mm

P-64032	Bag for 1000mm Jig	1000mm
---------	--------------------	--------

RT0700C / DRT50 INTERCHANGEABLE BASES

122703-7	Trimmer guide assembly	
195564-8	Guide holder set	

RT0700C / DRT50 TRIMMER BASE

196612-6

Enlarged opening section of base assembly for excellent bit visibility while maintaining durability

Round base assembly for smooth and fast cutting with easy handling

122703-7 Trimmer guide assembly can be used to follow a curved edge



RT0700C / DRT50 TILT (BEVEL) BASE

198987-9

Enlarged opening section of base assembly for excellent bit visibility

Tilting capacity: -30° to 45°



RT0700C / DRT50 OFFSET BASE

195562-2

Cut close to edges or corners (18.5mm)

Replicable plastic base assembly



RT0700C / DRT50 PLUNGE BASE

195563-0

Ergonomically contoured handles

3 stage cut depth adjustment

Plunge capacity: 0 - 35mm (0 - 1-3/8")

195564-8 Guide holder set is needed when using straight guide with the plunge base



GUIDES



Template Guide



Straight Guide
194935-6

Guide Rails on page 71

* Use with Guide Base Assembly 122256-6

¶ Use with 342428-9 Straight Guide and/or Trimmer Guide Assembly 123022-4

§ Use with Guide Base Assembly 122256-6

For accurate routing operations using a pattern

The RT700C with 195563-0 will take all template guides for RP2301

GUIDE BUSHES

For worktop jigs use
30mm guide bush.

164471-6

Size A - 27mm

Size B - 30mm

Size C - 13mm

344364-5

Size A - 14.5mm

Size B - 16mm

Size C - 13mm

193334-9

Size A - 14.5mm

Size B - 16mm

Size C - 13mm

30mm Guide Bush for

3612, 3612C, 3620,

RP0900, RP1801,

RP2301

16mm Guide Bush for

3612, 3612C, 3620,

RP0900, RP1801,

RP2301

16mm Guide Bush for

RP0910, RP1110C

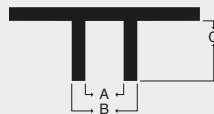

COLLET CONES, NUTS AND SLEEVES



*Select correct size of Collet to suit the Router Bit and use with Collet Nut 763615-1

ALWAYS use metric sleeves, cones and collets (together)

ALWAYS use imperial sleeves, cones and collets (together)

WRENCH REPLACEMENT



Part No.	Details	A mm	B mm	Size C mm	Model
----------	---------	------	------	-----------	-------

STRAIGHT GUIDE					
193312-9	Micro adjust				All Routers
342428-9*					3612/C
122391-0	Assembly				3708F, 3700
164834-6					3620, RP0910, RP1110C
122256-6¶	Guide Base				3612
194935-6	Straight Guide				RP1801, RP2301, 3612
122965-7	Straight Guide				RT0700C
TEMPLATE GUIDE					
343577-5		8	10	9.5	Trimmers
164379-4		7.7	9.5	11.5	3612/C
164775-6		9	11	13	RP1801, RP2301, 3612
164776-4		11	12.5	13	RP1801, RP2301, 3612
344364-5		14.5	16	13	RP1801, RP2301, 3612
164393-0		18	20	13	RP1801, RP2301, 3612
163080-8		25	29	15	RP1801, RP2301, 3612
164471-6		27	30	13	RP1801, RP2301, 3612
321492-3	Adaptor and roller	30	35	7	RP1801, RP2301, 3612
193330-7		7.7	9.5	11.5	RP0910, RP1110C
193331-5		9	11	11.5	RP0910, RP1110C
193332-3		10.5	12	14	RP0910, RP1110C
193333-1		11	12.7	11.5	RP0910, RP1110C
193334-9		14.5	16	11.5	RP0910, RP1110C
193335-7		18	20	13	RP0910, RP1110C
193340-4		22	24	13	RP0910, RP1110C
193336-5		24	27	13	RP0910, RP1110C
193337-3		25	29	13	RP0910, RP1110C
193338-1		27	30	13	RP0910, RP1110C
193339-9		37	40	13	RP0910, RP1110C
TRIMMER					
122703-7	Guide Assembly				3703, 3707/F, 3700
155263-4	Shoe				3707, 3708

ROUTER					
763805-6	Sleeve			3/8"	RP1801, RP2301, 3612, 3601B
763622-4	Cone			1/2"	RP1801, RP2301, 3612
763801-4	Sleeve			6mm	RP1801, RP2301, 3612
763804-8	Sleeve			8mm	RP1801, RP2301, 3612
763628-2	Cone			12mm	RP1801, RP2301, 3612
763629-0	Nut			1/2"	RP1801, RP2301, 3612
763637-1*	Cone			1/4"	RT0700C, RP0900
763619-3*	Cone			3/8"	RT0700C, RP0900
763636-3*	Cone			6mm	RT0700C, RP0900
763618-5*	Cone			8mm	RT0700C, RP0900
763615-1*	Nut			8mm	RT0700C, RP0900
193179-5	Cone and Nut Set			1/4"	RP0910, 1100C
193178-7	Cone and Nut Set			8mm	RP0910, 1100C
763652-5	Nut			8mm	RP0910, 1100C
763601-2	Cone			12mm	3600B
763602-0	Cone			12.7mm	3601B
763803-0	Sleeve			1/4"	3600B/3601B
TRIMMER					
763606-2	Nut			6mm	3700B, 3703, 3707, 3708
763607-0	Cone			6mm	3700B, 3703, 3707, 3708
763608-8	Cone			1/4"	3700B, 3703, 3707, 3708
763670-3	Cone			6mm	

781213-9				8	3620, RP1110C, 3600B, 3612BR, RP0910
----------	--	--	--	---	--------------------------------------

Batteries & Cases
Tool Holders
Drilling
Fixing
Saw Blades
Jigsaw & Recip
Multi Tool
Diamond
Bonded Abrasives
Flap Discs
Coated Abrasives
Router Cutters
Dust Extraction
Ground Maintenance

BISCUIT JOINER, PLANER, ENGINEERING: ACCESSORIES

Part No.	Details	Size mm	Bore mm
BISCUIT JOINER ACCESSORIES *****			
B-20644	TCT Cutter Blade	100 x 22 x 6T	20
P-08838	Biscuit Dowel (1000 pcs)	0	15 x 46
P-08844	Biscuit Dowel (1000 pcs)	10	18 x 51
P-08850	Biscuit Dowel (1000 pcs)	20	24 x 57



ALUMINIUM GROOVE CUTTER BLADES: CA5000 *****			
B-48832	For Ali Comp	118 x 6T x 90°	20
B-48860	For Ali Comp	118 x 6T x 135°	20



Replacement Blades for the CA5000, used for cutting grooves in aluminium composite materials.

Part No.	Details	Size D mm	Model T mm
----------	---------	-----------	------------

BLADES AND SET PLATES *****			
PLANER BLADES			
A-85400	Planer Blade x 2	50mm	1050DW, 1051DW
793004-6	HSS Blades x 2	82mm	1923B, BD, 1901
D-07967	TCT Blades x 2	82mm	1125, 1923
D-07945	TCT Mini Blades	82mm	All 82mm
P-04282	Mini Blades x 2	82mm	1923B, 1901, KP0800
D-16346	HSS Blades x 2	82mm	1100, 1902, N1923H, KP0800, KP0810
793322-2	TCT Blades x 2	82mm	1100, HP0810
793008-8	HSS Blades x 2	110mm	1911B
D-08822	TCT Blades x 2	110mm	1911B
B-02870	Blade for KP312	312mm	KP312
D-35302	TCT Mini blade x 5	82mm	5 pack of D-07945
SET PLATE			
A-86175	Planer	P-04282	1902, KP0800
345644-2	Planer HSS & TCT	P-04282	1923B, 1901, KP0810, 1100



GUIDE RULES AND GUIDE RULE ASSEMBLIES *****			
165581-2	Guide Rule		82mm Planers
161046-2	Guide Rule		110mm Planers



SHARPENING, GAUGES AND DRESSING STONES *****			
123004-6	Sharpening Holder	82mm	
123055-9	Sharpening Holder	110mm	
123062-2*	Blade Gauge		
D-17756	Dressing Stone 1200G	150x70x20	



* For resetting blades after sharpening

2012 THICKNESSER ACCESSORIES *****			
793346-8	Blade (2 Per Pack)		2012NB
193036-7	Hood Set		2012NB
194053-0	Stand		2012NB/NBX
782203-5	Socket Wrench		2012NB
782212-4	Socket Wrench	13mm	24B/27/5016B
783208-8	Hex Wrench		2012NB
762014-4	Magnetic Holder		2012NB



THICKNESS GAUGES *****			
762007-1		1,1.5,2mm	
762013-6		0.5,1,1.5mm	



Part No.

Details

Size
D mm

Model
T mm

WIRE BRUSHES



Knotted Cup: 0.5mm knotted steel wire for fast cleaning of large surfaces and heavy work.



Knotted Cup 2: 0.5mm knotted steel wire ideal for heavy work.



Crimp Cup: 0.3mm brass coated steel wire for light rust removal.



Twisted Wheel: 0.5mm knotted wire ideal for heavy cleaning at spot.

TWIST KNOT

D-24103	Knotted Cup	60mm	M10 x 1.5
D-24119	Knotted Cup	60mm	M14 x 2
D-24125	Knotted Cup	75mm	M10 x 1.5
D-24131	Knotted Cup	75mm	M14 x 2
D-24147	Knotted Cup 2	60mm	M10 x 1.5
D-24153	Knotted Cup 2	60mm	M14 x 2
D-29290	Knotted Cup 2	100mm/4"	M14 x 2
D-29555	Twisted Wheel	100mm/4"	M14 x 2
D-29561	Twisted Wheel	115mm	M14 x 2
D-29577	Twisted Wheel	125mm	M14 x 2

CRIMPED

D-24066	Crimp Cup	60mm	M10 x 1.5
D-24072	Crimp Cup	60mm	M14 x 2
D-24088	Crimp Cup	75mm/3"	M10 x 1.5
D-24094	Crimp Cup	75mm/3"	M14 x 2
D-29284	Crimp Cup	100mm/4"	M14 x 2t

*Knotted Cup for fast cleaning.

*Knotted Cup 2 for aggressive action for severe applications. (Heavy duty / more wire)

WIRE BRUSH SET - DRILL 3PC

D-66070

Shank 1/4" Straight
Max RPM 4500 rpm



NYLON BRUSH SET - DRILL 3PC

D-70742

80G (Red Coarse)



NYLON BRUSH SET - DRILL 3PC

D-70758

240G (Blue Fine)



Batteries & Cases
Tool Holders
Drilling
Fixing
Saw Blades
Jigsaw & Recip
Multi Tool
Diamond
Bonded Abrasives
Flap Discs
Coated Abrasives
Router Cutters
Dust Extraction
Ground Maintenance

Part No.	Model	D mm	Pack
REBAR AND THREADED ROD CUTTER ACCESSORIES - DSC102/DSC250/DSC251 *****			
199443-2	Cutter Blade	W5/16	DSC102
199444-0	Cutter Blade	W1/4	DSC102
199087-8	Cutter Blade	M6	DSC102
199085-2	Cutter Blade	M8	DSC102
199083-6	Cutter Blade	M10	DSC102
SC09030550	Spacer		DSC250
SC09003260	Flangeless Blade		DSC251



SHEAR BLADES *****			
191383-0	JS1600/02	Shear Blades	2
792287-5	JS3200	Shear Blades	2
792533-6	JS1601,	Side Blade	1
	BJS160/161 (set)		
792534-4	JS1660	Centre Blade	1
792537-8	JS1670	Centre Blade	1
SC09002450	SC161D (set)	Cutter Blade	1
195267-4	UM164D	Shear Blade	1
792742-7	BJS130	Shear Blade R	1
792743-5	BJS130	Shear Blade L	1
792744-3	BJS130	Centre Blade	1



PUNCHES AND DIES *****			
PUNCH			
792728-1	JN3200		1
792265-5	JN1600		1
A-83951	JN1601		1
DIE			
792292-2	JN3200 comes with case		1
A-15051	JN1601		1
322701-3	JN1601 Die Holder		1



TCT BURRS - DIE GRINDER *****			
B-52716-10	10x20x6mm (SA)		10
B-52744-10	10x20x6mm (SC)		10
B-52772-10	10x20x6mm (SF)		10
B-52803-10	10x25x6mm (SL)		10
B-52831-10	10x20x6mm (SM)		10



SA SC SF SL SM Head Type

COLLET CONES FOR DIE GRINDERS *****			
763626-6	906	1/8"	1
763627-4	906	3mm	1
763620-8	906	6mm	1
763625-8	906	6.35mm (1/4")	1
192988-9	GD0810C, GD0800	8mm	1
193012-1	GD0800, GD0810C	6mm	1
193011-3	GD0800, GD0810C	3mm	1
193143-6	GD0800, GD0510C	6.35mm (1/4")	1
763669-8	BGD800	3mm	1
763673-7		6.35mm (1/4")	1
763676-1		6.35mm (1/4")	1



COLLET SLEEVES AND NUTS FOR DIE GRINDERS *****			
763646-0	GD0800C	Sleeve, 6mm	1
763606-2	37007B, 906, 3707	Nut, 6mm	1
763645-2	GD0800C	Nut, 6mm	1
763664-8	GD0600	Nut, 6mm	1



Part No.

Details

LASER TRIPODS AND MEASURING ROD



P-81088	Construction Level Tripod
P-81315	Tripod Elevating Column 2.70m, Fine Adjustment
P-81309	Measuring Rod 4m

SK102 / SK103 / SK104 / SK105 / SK106 ACCESSORIES



LE00785640	Detector SK102
LE00785637	Wall Bracket SK102 / SK103 / SK104
LE00785519	Ball Adapter
LE00785638	Target plate with magnet and stand SK102
LE00785633	Magnetic Wall Mount with Adaptor 1/4" to 5/8"
LE00785636	Holster Belt Pouch with Carry Loop SK102
LE00837085	Detector SK103 / SK104
LE00758831	Target plate red
LE00772796	Laser visibility glasses green
LE00823195	Target plate green
LE00835249	Receiver bracket
LE00855702	LDX1 line laser receiver set
LE00864505	Makita td holster
199178-5	USB Power Supply Cable - SK105/SK106
199006-4	USB Power Supply Cable - SK209GDZ/SK312GDZ

SKR200 ACCESSORIES



LE00796587	Receiver LR150
LE00796588	Remote RC30
LE00791661	Wall Mount
LE00775106	Target Plate
LE00784968	Magnetic Bracket for Laser Receiver

Batteries & Cases
Tool Holders
Drilling
Fixing
Saw Blades
Jigsaw & Recip
Multi Tool
Diamond
Bonded Abrasives
Flap Discs
Coated Abrasives
Router Cutters
Dust Extraction
Ground Maintenance

Dust Extraction and Vacuum Cleaner Accessories

Makita offers a wide range of attachments, adaptors and hoses that allows you to connect your machine to a dust extractor. We also offer a range of nozzles and attachments for your vacuum cleaners and dust extractors suitable for any job.



M Class Dust Extraction

M Class dust extraction is now the minimum legal requirement when working with hazardous materials:

Brick, Masonry, Tile, Gravel, All woods,
Plastic composites, Flint, Quartz and
Liquid materials containing sand.

Don't use your lungs as the filter. Use your M Class dust extraction unit to protect yourself from these hazardous materials.



CLASS



DUST EXTRACTION ATTACHMENT SET

196074-8

Dust extraction for combi hammer and SDS-MAX drilling, also suitable for breaking. Maximum drill depth 570mm, max diameter 40mm.

Suitable for models: HR4510C and HR4511C



DUST EXTRACTION ATTACHMENT SET

199142-6

TNO certified dust extraction adapter for SDS-MAX drilling, also suitable for breaking. Maximum drilling depth 380mm, maximum diameter 40mm.

Suitable for model HR4013. Rotary and hammer mode capabilities.



DUST EXTRACTION ATTACHMENT SET

196858-4

Dust extraction adapter for combi hammers, for SDS-MAX drilling; also suitable for breaking. Maximum drilling depth 570mm, maximum diameter 40mm.

Suitable for model HR5212C. Dust extractor attachment can be attached without replacing the side handle. Rotary and hammer mode capabilities.



DUST EXTRACTION ATTACHMENT SET

199144-2 / 199143-4

Dust extraction adapter for hammer mode.

Suitable for SDS-Max and 17mm hex chisels.

199144-2: Includes hose

199143-4: Excludes hose



DUST EXTRACTION ATTACHMENT SET

197148-8 / 197168-2

Provides a virtually dust free environment when combined with extraction system.

- Removes 95% of total dust particles produced during operation
- Compatible with 28mm hoses of Makita vacuum cleaners without an adapter
- Dust cover position can be easily changed.
- Compatible with 15kg - 30kg class demolition hammers

197148-8: Includes hose

197168-2: Excludes hose



DUST EXTRACTION ATTACHMENT SET

199563-2 / 199570-5

199563-2: DX06 for DHR242
199570-5: DX07 for DHR243

196165-5 Filter Set



DUST EXTRACTION ATTACHMENT SET

199581-0 / 199585-2

199581-0: DX08 for DHR280
199585-2: DX09 for DHR281

199557-7 Filter Set



WALL DRILLING KIT

P-80488

Dust extractor adaptor that attaches itself to the wall, ideal for any drilling application up to 25mm diameter.

Connection:
27 - 36mm Outside
24mm Inside



DUST EXTRACTION: ACCESSORIES

		Part No.	Details	Model
DUST COVERS AND COLLECTORS				
 <p>192176-8 P-11564</p>	423154-0	Dust Cover	HK1800	
	421342-3	Dust Cap	HR2010/2440	
	192176-8	Dust Extraction System	HR2400/2510/ 2410	
	192175-0	Dust Extraction System	HR3520	
	192278-0	1.5m Hose	HR2400/ HR2510/2450	
	192279-8	3.0m Hose	HR3520/ HR2410	
	P-11564	Dust Collector only	8406/8406C	
	415164-1	Dust Cover	8406/8406C	
	421182-9	Dust Cover	8406C	
	196022-7	Dust Cover	TM3000	
	196520-1	Dust Nozzle Set	DHS710ZJ	
	199627-2	Dust attachment set	DTM41/51	
	194233-8	Dust Cover	PW5000C	
	193472-7	Dust collector	HR2450	

		Part No.	Details	Model
VACUUM HEAD SETS AND NOZZLES				
 <p>192035-6 192547-9</p>	415412-8	Dust nozzle	3612/3612C	
	192547-9	Vacuum head	4304/4305/ 4304T	
	417853-4	Dust nozzle	4340/4341	
	122850-4	Dust nozzle	RP1801/RP2301FC	
	194733-8	Dust nozzle	RP0900K	
	415412-8	Dust nozzle	3612	
	192035-6	Vacuum head set	3620	
	123559-1	Dust Collector	DSD180	
	192547-9	Dust nozzle	4304/4305/4306	
	417853-4	Dust nozzle	4340/4350	

		Part No.	Details	Model
DUST EXTRACTION GUARD				
 <p>A B C</p> <p>D E</p>	192188-1	125mm (5") dustless guard (A)	9005B	
	194044-1	Dustless guard (push/pull) 9" (A)	9049F/9049SF	
	193794-5	Dustless guard (A)	9015B	
	196845-3	Dust collecting set (A)	9565H	
	195385-8	Dust cover set (C)	180mm grinders	
	195239-9	Dust cover set (C)	115/125mm grinders	
	194303-3	Dustless guard (A)	180mm grinders	
	196845-3	Dustless guard (D)	125mm grinders	
	192972-4	Dustless guard (A)	115/125mm grinders	
	198440-5	Dustless guard (E)	230mm grinders	

		Part No.	Details	Model
HOSE ADAPTORS				
 <p>192349-3 P-70421 P-72936 Stepped Adaptor</p>	P-70384	Coupling sleeve Quick system	36mm	
	P-70390	Std coupling sleeve	50 / 36mm	
	P-70409	Std coupling sleeve	50 / 27mm	
	P-70415	Std Power tool adaptor Anti Static	27 / 25-38mm	
	P-70421	Std Power tool adaptor	36 / 38mm	
	P-72936	Power tool adaptor Quick system	32 / 25-38mm	
	P-70378	Power tool adaptor Quick system	36mm	
	W6360	Hose connector sleeve	36mm	
	192349-3	Power tool adaptor Quick system	25 / 22mm	
	P-81745	Power tool adaptor	32 x 25-38mm	

Part No.

Details

Model

DUST BAGS AND ADAPTORS FOR TOOLS



Standard Dust Bag



194175-6 (Cyclone Dust Box)

Mitre Saw Dust Box uses centrifugal force to create a cyclonic air movement for cleaner, more efficient dust collection. Coarse dust is captured by large primary chamber and fine sawdust is captured by small secondary chamber. Expelled air is virtually dust free. Hinged bottom trap door enables dust box to be emptied quickly and easily. This is an ideal replacement for traditional cloth dust bags.

122230-4	Dust Bag Assembly	1100
STEX122312	Dust Bag Assembly (includes nozzle assembly)	1100
152122-3	Joint (supplied with machine)	1902
122474-6	Dust Bag Assembly	3901
122652-8	Nozzle Adaptor	9032
152456-4	Dust Bag Complete	9046
414889-4	Hose Reducer, connects 34mm to 38mm Hose	9046/BO4553
193293-7	Paper Dust Bag (x5)	9046/BO4900
122297-2	Dust Bag complete with Fastener	9402
192613-2	Dust Extraction Nozzle (Elbow Joint 32)	4105KB/ 9402/PC1100
122562-9	Dust Bag Assembly	9403
416497-7	Dust Nozzle	9403
122591-2	Dust Bag Assembly	DSS610/9920/ 9903/9404
122329-5	Dust Bag	9901
122548-3	Dust Bag Assembly	9911
JPA122275	Joint 55 Assembly	1100/1902
196300-5	Dust Bag	1911B
192082-7	Nozzle Assembly	1911B
123185-6	Dust Bag	4105KB
140115-2	Dust Bag	BO3710/3711
193712-3	Paper Dust Bag (x5)	BO4555
166078-4	Dust Bag Cloth	BO4555
193294-5	Paper Dust Bag Assembly	BO6080/9046/ BO4900
151518-5	Nozzle Complete	BO6030
151517-7	Dust Bag Assembly Cloth	BO6030/4900
122793-0	Dust Bag Assy	DKP180 KP0810/0800
414568-4	Dust Nozzle/Elbow	LS1013
122852-0	Dust Bag	LS1016/LS1216 LS1019
JM23100501	Dust Bag	LS1018
123203-0	Dust Bag	PC1100
122615-4	Dust Nozzle Assembly	RP1110C
194175-6	Mitre saw dust box	Mitre saws
STEX122269	Dust bag	1901
122296-4	Dust bag	9900B/9924DB
122321-1	Dust bag	UB141DZ/2400B/ 4014B
122339-2	Dust bag	9045N
122351-2	Dust bag	LS1030
122469-9	Dust bag	1050/51D
122814-8	Dust bag	BUB142/182
122853-8	Dust bag	PC5000/5001C
166027-1	Dust bag	BO4550/54/61
166106-5	Dust bag	EK7650H0H
151780-2	Dust bag cloth	BO3700
122708-7	Dust bag	HR2432
151780-2	Dust bag cloth	BO3700
196298-6	Dust bag	1923H
122918-6	Dust bag	DVC340/350

WIRELESS UNIT ADAPTOR

199804-6 / 191A40-6

199804-6:

198900-7 chip)

191A40-6:

198900-7 chip)

198900-7: Wireless AWS Bluetooth Chip



DUST EXTRACTION: GUIDE

MACHINE	ATTACHMENT	CUFF
ROTARY HAMMERS		
BHR262/T	193472-7 + 192349-3	22mm
DHR162	193472-7 + 192349-3	22mm
DHR164	193472-7 + 192349-3	22mm
DHR165	193472-7 + 192349-3	22mm
DHR202	193472-7 + 192349-3	22mm
DHR263	193472-7 + 192349-3	22mm
DHR264	193472-7 + 192349-3	22mm
HR2470	193472-7 + 192349-3	22mm
HR2601	193472-7 + 192349-3	22mm
HR2610	193472-7 + 192349-3	22mm
HR2611	193472-7 + 192349-3	22mm
HR2811	193472-7 + 192349-3	22mm
HR2300	195180-6	22mm
HR2600	195180-6	22mm
HR2601	195180-6	22mm
HR2630	195180-6	22mm
HR2610T	195180-6	22mm
HR2611F/FT	195180-6	22mm
HR4001C	195866-2	22mm
HR4011C	195866-2	22mm
HR4511C	195866-2	22mm
HR5211C	195866-2	22mm
HR4013C	196536-6	22mm
HR5212C	196861-5	22mm
HR166D	198376-8	22mm
HR140D	198376-8	22mm
DHR182	198362-9	22mm
DHR171	P-80488	24mm
HR2650	P-80488	24mm
HR2651	P-80488	24mm
HR1840	P-80488	24mm
HR1841F	P-80488	24mm
DEMOLITION HAMMERS		
HM1101C/11C	196571-4	28mm direct to hose
HM0870C/71C	196571-4	28mm direct to hose
HM1203C/13C	196571-4	28mm direct to hose
HM1214C	196571-4	28mm direct to hose
HM1304/B	*197168-2* or **197148-8	28mm direct to hose
HM1317C/CB	*197168-2* or **197148-8	28mm direct to hose
HM1812	*197168-2* or **197148-8	28mm direct to hose
HM1810	*197168-2* or **197148-8	28mm direct to hose
<i>*197168-2 without 28mm hose **197148-8 with 28mm hose</i>		
DRYWALL CUTTERS		
3706	193449-2	22mm
DCO180	193449-2	22mm
SD100D	451177-8	22mm
ROUTERS		
<i>When used with plunge base</i>		
RP0910	NO ATTACHMENT REQUIRED	22mm
RP1110C	NO ATTACHMENT REQUIRED	22mm
RP1801X	194934-8 OR 122850-4	38mm
RP2301FCX	194934-8 OR 122850-4	38mm
RP0900	194733-8	38mm
RT0700C	195559-1	38mm
*RT0700C	194733-8	38mm
DRT50	195559-1	38mm
JIGSAWS		
DJV180/140	417853-4 + 192349-3	22mm
DJV182/142	126331-0 + 195546-0	24mm
DJV181/141	126331-1 + 195546-0	24mm
4329	192349-3	22mm
JV0600	192349-3	22mm
4350CT/FCT	417853-4 + 192349-3	22mm
4351FCT	417853-5 + 192349-3	22mm
JV102D	457801-1	22mm
JV103D	457801-1	22mm
DISC CUTTERS		
4112HS	192613-2	38mm
4114S	192613-2	38mm
4105KB	192613-2	38mm
4100KD	NO ATTACHMENT REQUIRED	38mm
WALL CHASERS		
SG1251J	NO ATTACHMENT REQUIRED	38mm
CONCRETE PLANERS		
PC5000C	NO ATTACHMENT REQUIRED	38mm
PC5001C	NO ATTACHMENT REQUIRED	38mm
PC5010C	NO ATTACHMENT REQUIRED	38mm
MULTI TOOLS		
DTM50/40	195965-0	22mm
DTM51	196765-1	22mm
TM3000C	196022-7	22mm
TM3010C	196550-2	22mm

MACHINE	ATTACHMENT	CUFF
ANGLE GRINDERS		
<i>Cup Type Diamond Wheel</i>		
115/125mm	195239-9	38mm
180/230mm	195385-8	38mm
Enclosed Dust collecting guard		
125mm	196845-3	38mm
230mm	198440-5	38mm
Dust collection wheel guard		
115/125mm	193794-5	38mm
180mm	194303-3	38mm
230mm	194044-1	38mm
PLANERS		
KP0810K/CK	NO ATTACHMENT REQUIRED	38mm
DKP180	451329-1	38mm
KP0800	451329-1	38mm
1911B	192082-7	38mm
1100	315879-8 + JPA122275	38mm
1806B	122397-8 + 181575-9	38mm
KP312	193733-5 + 181575-9	38mm
BISCUIT JOINTERS		
PJ7000	NO ATTACHMENT REQUIRED	22mm
DPJ180/140	NO ATTACHMENT REQUIRED	22mm
BELT SANDERS		
9401	NO ATTACHMENT REQUIRED	38mm
9403	NO ATTACHMENT REQUIRED	38mm
9903	NO ATTACHMENT REQUIRED	38mm
9920	NO ATTACHMENT REQUIRED	38mm
9911	NO ATTACHMENT REQUIRED	38mm
9032	122652-8	22mm
9031	NO ATTACHMENT REQUIRED	22mm
FINISHING SANDERS		
BO3710/11	NO ATTACHMENT REQUIRED	22mm
BO4555/56	NO ATTACHMENT REQUIRED	22mm
BO4900/V	NO ATTACHMENT REQUIRED	22mm
RANDOM ORBITAL SANDERS		
BO5030/31	NO ATTACHMENT REQUIRED	22mm
BO5041	NO ATTACHMENT REQUIRED	22mm
BO6030/40	NO ATTACHMENT REQUIRED	22mm
DBO180/140	NO ATTACHMENT REQUIRED	22mm
BO6050J	NO ATTACHMENT REQUIRED	22mm
DRYWALL SANDERS		
DSL800	NO ATTACHMENT REQUIRED	38mm
CIRCULAR SAWS		
DHS630	194314-8	22mm
DSS611/610	419283-5	22mm
DSS501/500	194415-2	22mm
HS300D/01D	452237-9	22mm
DHS710/711	196520-1 + 195546-0	24mm
HS7100	453289-3 + 195546-0	24mm
DHS680	196961-1 + 195546-0	24mm
5704RK	192420-3	38mm
5703R	192420-3	38mm
5143R	192490-2	38mm
5008MG	450079-5	38mm
5103R	415426-7	38mm
5903R	415426-8	38mm
5604R	NO ATTACHMENT REQUIRED	38mm
5017RK	NO ATTACHMENT REQUIRED	38mm
SP6000	195546-0	24mm
DSP600	457752-8	24mm
DSP601	457752-8	24mm
CA5000	195546-0	24mm
HS0600	198263-1	24mm
HS7611	196520-1	24mm
DHS660/661	199230-9	24mm
DHS782	196520-1	24mm
DHS783	196520-1	24mm
MITER SAWS AND TABLE SAWS		
DLS713	NO ATTACHMENT REQUIRED	38mm
LS0815FL	NO ATTACHMENT REQUIRED	38mm
DLS714	NO ATTACHMENT REQUIRED	38mm
LS0714/L	NO ATTACHMENT REQUIRED	38mm
LS1016L	NO ATTACHMENT REQUIRED	38mm
LS1018L	NO ATTACHMENT REQUIRED	38mm
LS1216L	NO ATTACHMENT REQUIRED	38mm
LS1040	NO ATTACHMENT REQUIRED	38mm
LF1000	NO ATTACHMENT REQUIRED	38mm
LH1040	NO ATTACHMENT REQUIRED	38mm
LH1200FL	NO ATTACHMENT REQUIRED	38mm
LB1200F	JM27000090	38mm
2704	419093-0	38mm
MLT100	JM27000090	38mm
2712	JM27000090	38mm
DLS600	NO ATTACHMENT REQUIRED	38mm
LS1019/LS1019L	123980-4	38mm
DLS110	126751-8	38mm
LS1219/LS1219L	NO ATTACHMENT REQUIRED	38mm
DLS211	NO ATTACHMENT REQUIRED	38mm

DUST EXTRACTION: ACCESSORIES

Part No.	Details											
		447L	447M	446L	VC2012L	VC2511	VC3011L	VC3211M/H	VC3012M/L	DVC861Z	VC11310L	VC4210MX
DUST BAGS												
P-70297	Disposal bag set of 5			•	•	•	•		•			
P-70306	Disposal bag set of 5	•	•									
P-70194	Dust bag set of 5			•					•			
P-70203	Dust bag set of 5	•	•									
P-78293	Filter bag set of 5								•			
P-72899	Filter bag set of 5				•	•						
195558-3	Filter bag set							•				
195440-6	Poly bag set							•				
P-80575	Dust bag set of 2			•	•							
P-81804	Filter bag set 2	•	•									
A-49557	Dust bag								•	•		
195432-5	Poly bag								•	•		•
P-84078	Dust bag set of 5							•				
W107418355	Disposal bag set of 5										•	
W107418353	Fleece Filter Bags set of 5										•	
W107418354	Long-Life Filter Bag										•	
FILTERS												
W302000525	Cloth filter	•	•									
W15475	Filter sieve for WET use	•	•	•								
W302000606	Cloth filter			•								
P-70225	Filter cartridge	•	•									
P-70219	Filter cartridge			•	•	•	•		•			
196253-8	Pre-filter							•				
196251-2	Powder Filter H Set							•				
W107418351	PTFE main filter										•	
W107418352	PET motor cooling filter										•	
HOSES												
P-72920	Suction hose 36mm x 3000kpl quick system	•	•	•								
P-70362	suction hose 36mm x 3000kpl anti static quick system	•	•	•								
P-70487	Std equip suction hose 27 mm X 3500 antistatic	•	•	•								
P-72914	Suction hose 32mm x 3.5m quick system				•	•	•					
195434-1	Hose 38mm x 2.5m for cleaning with front cuffs 38							•				•
195433-3	28mm x 3.5m for power tools with front cuffs 22, 38							•				•
P-81739	32mm x 3.5m											•
417766-9	Front Cuff											•
P-72958	W8046	P-72964	P-70471	W6084	W15348	W5067	P-70465	195551-7	A-47846	410306-2		
NOZZLES												
P-72958	Professional nozzle	•	•	•	•	•	•					
P-72964	Water suction nozzle	•	•	•	•	•	•					
P-70471	Brush nozzle long	•	•	•	•	•	•					
W6084	Corner nozzle	•	•	•	•	•	•					
W15348	Professional nozzle with brush strip	•	•	•	•	•	•					
W5067	Flex nozzle	•	•	•	•	•	•					
P-70465	Floor nozzle	•										
195551-7	Universal type nozzle assembly							•				
A-47846	Wide type nozzle assembly							•				
410306-2	Corner nozzle							•		•		
P-81789	Floor nozzle							•				
P-72942	P-70346	P-70437	P-72908	192562-3								
PIPES												
P-72942	Extension tubes	•	•	•	•	•	•					
P-70346	Curved hand tube 36mm quick system	•	•	•								
P-70437	Straight pipe	•	•	•				•				
P-72908	Curved hand tube				•	•						
192562-3	Bent pipe set							•			•	
P-70502	P-70518	P-70312	P-70328	P-73075	195439-1	197323-6	W107418349					
SETS												
P-70502	Nozzle set 1	•	•	•	•	•	•		•			
P-70518	Nozzle set 2	•	•	•	•	•	•					
P-70312	Makita set 1	•	•	•	•	•	•					
P-70328	Makita set 2	•	•	•	•	•	•					
P-73075	Makita set professional	•	•	•	•	•	•		•			
195439-1	Cleaning set							•				
197323-6	Hose stand							•		•	•	
W107418349	Cleaning set										•	

Batteries & Cases
Tool Holders
Drilling
Fixing
Saw Blades
Jigsaw & Recip
Multi Tool
Diamond
Bonded Abrasives
Flap Discs
Coated Abrasives
Router Cutters
Dust Extraction
Ground Maintenance

VACUUM CLEANER: ACCESSORIES

Part No.	Details
----------	---------

DRC200



SH0000231	Sensor Wall Tape
SH0000065	Side Brush
SH0000064	Turn Brush Cover
SH0000213	Filter

BACK-PACK VACUUMS



DVC260	
143787-2	28mm Hose (For Cleaning)
195547-8	Front Cuffs 22
195546-0	Front Cuffs 24
195545-2	Front Cuffs 38
123584-2	Telescopic Pipe Assembly
126756-8	Bent Pipe
123486-2	Floor Nozzle
166116-2	Hose Band
123636-9	Filter Set Assembly (Hepa)
197903-8	Filter Bag (X10)
197899-3	Dust Bag Assembly (Reusable)
191496-7	Flexible hose
198532-0	Combination white nozzle set
198990-0	Blue corner nozzle
DVC261	
127082-8	Nozzle assembly
127093-3	Bent pipe assemble
140G19-0	Telescopic pipe comp

VACUUM CLEANING ACCESSORIES



Part No.	Details													
		CL121	CL100	CL104	CL106	CL108	CL070	CL183	DCL180/140	DCL181	DCL182	DCL280	DCL281	DCL282
CAPSULE VACS														
198915-4	Filter													
198751-8	Pre filter													
198753-4	Easy shake off dust filter													
PAPER BAG VACS														
198745-3	Paper filter x5													
198747-9	Dust bag													
198749-5	Easy shake off dust bag													
194566-1	Paper Filter x5													
HOSES AND PIPES														
198547-7	Flexible hose - Black													
198560-5	Telescopic pipe - White													
NOZZLES														
123539-7	Floor T-Nozzle - Black													
123486-2	Floor T-Nozzle - White													
123488-8	Floor T-Nozzle - Blue													
198873-4	Shelf brush - White													
198878-4	Round brush - White													
198990-0	Corner nozzle - Blue													
199041-2	Car seat nozzle - Blue													
451240-7	Sash nozzle - White													
191657-9	Large round brush													
CYCLONE ATTACHMENTS														
191D71-3	Cyclone Attachment With Lock - White													
191D73-9	Cyclone Attachment With Lock - Black													
191D75-5	Cyclone Attachment Without Lock - Black													
191D76-3	Straight Pipe Without Lock - White													
191D77-1	Straight Pipe Without Lock - Black													
191D79-7	Straight Pipe 320 Without Lock - White													
191D80-2	Straight Pipe 320 Without Lock - Black													
OTHER														
458571-5	Wall bracket													



Floor T-Nozzle
Black / Blue / White



Shelf Brush



Round Brush

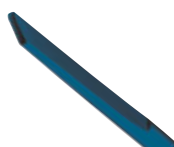

Corner Nozzle



Car Seat Nozzle



Sash Nozzle



Cyclone
Black / White

Heat Gun Accessories

Makita offers variety of heat gun accessories, specially designed for a wide range of applications. All accessories are manufactured to our exceeding high standards ensuring work can be carried out with no interruptions.



Applications



Part No.	Model	Pack
----------	-------	------

HEAT GUN NOZZLES



FOR HG5012 / HG651		
P-71423	Wide slot nozzle	1
P-71439	Reduction nozzle 20mm	1
P-71445	Reflection nozzle	1
P-71451	Welding nozzle	1
P-71473	Speed weld set	1
P-71510	Bonding rods PP	10
P-71526	Bonding rods HDPE	10
P-71532	Bonding rods ABS	10
P-71548	Scraper	1
FOR HG5030 / HG6531		
PR00000028	Glass protection nozzle	1
PR00000029	Wide slot nozzle	1
PR00000030	reflection nozzle	1
PR00000031	Reduction nozzle 20mm	1
PR00000032	Overlap welding nozzle	1
PR00000033	Solder sleeve reflector	1
PR00000034	Welding nozzle	1
PR00000035	Pressure roller	1
PR00000036	Abs welding rods	10
PR00000037	HDPE Welding rods	10
PR00000038	PP Welding rods	10
PR00000039	Speed welding nozzle	1
PR00000040	Scraper	1
PR00000041	Scraper set	1
PR00000042	Scraper	1

Ground Maintenance, Landscaping and Forestry

All Makita ground maintenance, landscaping and forestry products are designed with Makita's core values of reliability, power and efficiency whilst utilising the best advances in technology. All areas of our outdoor power product range have been researched and developed by Makita to the highest standards for the needs of the professional user.



WORKING JACKET

50% Cotton
50% Polyester

988614052 S/M
988614056 L/XL



WORKING JACKET SUPER

100% Polyester

988633852 S/M
988633856 L/XL



PRO CUTTING JACKET - EN381, CLASS 1 (20m/s)

50% Cotton
50% Polyester

988604852 S/M
988604856 L/XL

PROTECTION:
EN381, CLASS 1 (20m/s)



FORESTRY SAFETY HELMET WITH VISOR

P-54140

Forestry Combination Safety
Helmet with Visor.



TROUSERS TYPE A - EN381, CLASS 1 (20m/s)

50% Cotton
50% Polyester

- 988627048 32"
- 988627050 34"
- 988627052 36"
- 988627054 38"
- 988627056 40"

9 LAYERS OF PROTECTION:
EN381, CLASS 1 (20m/s)



B&B TROUSERS TYPE A - EN381, CLASS 1 (20m/s)

50% Cotton
50% Polyester

- 988628048 32"
- 988628050 34"
- 988628052 36"
- 988628054 38"
- 988628056 40"

9 LAYERS OF PROTECTION:
EN381, CLASS 1 (20m/s)



TROUSERS SUPER TYPE A - EN381, CLASS 1 (20m/s)

100% Polyamide

- 988629848 32"
- 988629850 34"
- 988629852 36"
- 988629854 38"
- 988629856 40"

9 LAYERS OF PROTECTION:
EN381, CLASS 1 (20m/s)



B&B TROUSERS SUPER TYPE A - EN381, CLASS 1 (20m/s)

100% Polyamide

- 988630848 32"
- 988630850 34"
- 988630852 36"
- 988630854 38"
- 988630856 40"

9 LAYERS OF PROTECTION:
EN381, CLASS 1 (20m/s)



PRO TROUSERS TYPE A - EN381, CLASS 1 (20m/s)

100% Polyamide

- 988631848 32"
- 988631850 34"
- 988631852 36"
- 988631854 38"
- 988631856 40"

6 LAYERS OF PROTECTION:
EN381, CLASS 1 (20m/s)



BRACES WITH CLIPS

P-72176

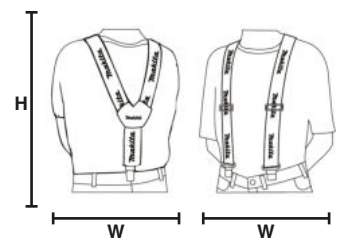

One size fits all. Designed to transfer weight from waist to shoulders. Straps with two steel buckles makes it easy to adapt the length to your body. Made of strong and durable 50 mm width elastic rubber.

Height	universal
Width	50mm
Length	-
Weight	0.23kg
Capacity	-

HOBBY SAFETY KIT AND HELMET WITH VISOR

The Safety Starter Set contains protective forester trousers in line with the DIN EN 381 standard, a protective helmet with a visor, ear protection in line with the DIN EN 397 standard and protective gloves for chainsaw use.

- 988001611 Large
- 988001613 Extra Large



SAFETY KIT

P-64923

- Eye Protection
- Ear Defenders
- Gloves
- Dust Mask



CHAINSAW GLOVES

988000103

Protective gloves for chainsaw use



Part No.	Details
DISC CUTTER ACCESSORIES	
TROLLIES	
394369610	Guide Trolley DT4000 for EK7650H/EK7651H
OTHER POPULAR ACCESSORIES	
957173060	Air Filter Set
123369-6	Water Supply Kit
394114272	Wheeled Foot with roller
326173081	New Pre Filter - DPC6410/7311
394173010	Main Air Filter - DPC6410/7311/8012
394173020	Inner Filter - DPC6410/7311/8012
988959402	Storage and Carry Case (metal)
P-54047	Water Tank 15L with 3m hose
442165-6	Air Filter - EK7650H
424399-3	Inner Filter - EK7650H
424701-0	Air Filter - EK7301/EK8100
424705-2	Inner Filter DPC6430/7331/813
395173081	Pre Filter - EK7301/EK8100
424789-0	Air Filter Insert EK6100
422201-4	Inner Filter EK6100
183J43-8	water attachment EK6100



P-54047

BREAKER / PUNCH	
950100310	Chain breaker
950100350	10mm punch



WRENCH	
958501699	Combi wrench 13 / 16 mm (with 1 nut)
958501633	Combi wrench 13 / 19 mm (with 2 nuts)
941713001	Combi wrench 13mm



SMARTHOLDER CHAINSAW HORSE	
P-71691	Smartholder chainsaw horse

Wood thickness: 1cm - 23cm
Wood Length: No limit



WEDGES	
988070010	High Lift Wedge
988070101	Aluminium Wedge 26cm
988070819	Plastic Wedge 20cm

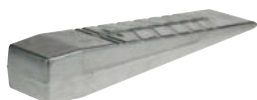

FILES / SHARPENING	
958500617	Round 4mm (5/32") 3 Pack
958500618	Round 4.5mm (11/64") 3 Pack
958500619	Round 4.8mm (3/16") 3 Pack
958500620	Round 5.5mm (7/32") 3 Pack
958500166	File and guide 4mm (5/32")
953003060	Flat file for chain
953004010	File handle
953100090	Filing gauge
953030040	File guide
953007000	Filing clamp
950100411	Rivet spinner
950100424	Jig for 1/4" & 0.325" pitch chain
950100425	Jig for 3/8" & 0.404" pitch
965210026	Grinding disc
965210027	Grinding disc
D-67359	Round File 4.0mm (5/32") x2
D-67371	Round File 4.5mm (11/64") x2
D-67393	Round File 4.8mm (3/16") x2
D-67418	Round File 5.2mm (13/64") x2
D-67430	Round File 5.5mm (7/32") x2
D-67452	Flat File 150mm (6")
D-67474	Depth Gauge Tool
D-67480	Loggers Filing Vice
D-67496	Wood File Handle
D-70948	Round File & Guide Set 4mm
D-70954	Round File & Guide Set 4.5mm
D-70960	Round File & Guide Set 4.8mm
D-70976	Round File & Guide Set 5.2mm
D-70982	Round File & Guide Set 5.5mm
D-70998	Flat File & Depth Gauge Set



2 STROKE OIL - 50:1 RED 100ML

P-21135

A premium quality semi-synthetic lubricant offering unrivalled engine protection under all conditions. Designed for garden machinery. It is suitable for use as a pre-mix or in oil injection systems with fuels including LRP, leaded or unleaded petrol. Benefits include: Extended engine life, low smoke, reduced carbon build up and extra lubricity for use with lead free fuel.



2 STROKE OIL - 50:1 RED 1 LITRE

P-21141

A premium quality semi-synthetic lubricant offering unrivalled engine protection under all conditions. Designed for garden machinery. It is suitable for use as a pre-mix or in oil injection systems with fuels including LRP, leaded or unleaded petrol. Benefits include: Extended engine life, low smoke, reduced carbon build up and extra lubricity for use with lead free fuel.



2 STROKE OIL - 50:1 RED 5 LITRE

P-21157

A premium quality semi-synthetic lubricant offering unrivalled engine protection under all conditions. Designed for garden machinery. It is suitable for use as a pre-mix or in oil injection systems with fuels including LRP, leaded or unleaded petrol. Benefits include: Extended engine life, low smoke, reduced carbon build up and extra lubricity for use with lead free fuel.



2 STROKE OIL - 50:1 RED 1 LITRE

980008607

A premium quality semi-synthetic lubricant offering unrivalled engine protection under all conditions. Designed for garden machinery. It is suitable for use as a pre-mix or in oil injection systems with fuels including LRP, leaded or unleaded petrol. Benefits include: Extended engine life, low smoke, reduced carbon build up and extra lubricity for use with lead free fuel.



4-STROKE OIL - SAE 30 1 LITRE

P-21200

4 stroke engine oil is a high performance lubricant formulated from a carefully balanced mixture of mineral base stocks fortified with the latest additive technology. 4 Stroke is suitable for all makes of four stroke petrol and naturally aspirated diesel stationary engines found on horticultural machines.



4-STROKE OIL - SAE 30 5 LITRE

P-21216

4 stroke engine oil is a high performance lubricant formulated from a carefully balanced mixture of mineral base stocks fortified with the latest additive technology. 4 Stroke is suitable for all makes of four stroke petrol and naturally aspirated diesel stationary engines found on horticultural machines.



4-STROKE OIL - SAE 10W 30 1 LITRE

P-21244

4 stroke engine oil is a high performance lubricant formulated from a carefully balanced mixture of mineral base stocks fortified with the latest additive technology. 4 Stroke is suitable for all makes of four stroke petrol and naturally aspirated diesel stationary engines found on horticultural machines.



CHAIN & BAR OIL - BIO 1 LITRE

980008610

Bar guard saw chain oil brings high technology to chain saw lubrication. It's unique formula both resists flinging and provides superb lubrication to bar and chain. Special adhesive properties ensure excellent fling resistance and low maintenance.



CHAIN & BAR OIL - BIO 5 LITRE

980008611

Bar guard saw chain oil brings high technology to chain saw lubrication. It's unique formula both resists flinging and provides superb lubrication to bar and chain. Special adhesive properties ensure excellent fling resistance and low maintenance.



CHAIN & BAR OIL - NON-BIO 1 LITRE

P-21163

Bar guard saw chain oil brings high technology to chain saw lubrication. It's unique formula both resists flinging and provides superb lubrication to bar and chain. Special adhesive properties ensure excellent fling resistance and low maintenance.



CHAIN & BAR OIL - NON-BIO 5 LITRE

P-21179

Bar guard saw chain oil brings high technology to chain saw lubrication. It's unique formula both resists flinging and provides superb lubrication to bar and chain. Special adhesive properties ensure excellent fling resistance and low maintenance.



CHAIN & BAR OIL - NON-BIO 25 LITRE

P-21185

Bar guard saw chain oil brings high technology to chain saw lubrication. It's unique formula both resists flinging and provides superb lubrication to bar and chain. Special adhesive properties ensure excellent fling resistance and low maintenance.



GROUND MAINTENANCE, LANDSCAPING AND FORESTRY: CHAINSAW ACCESSORIES

Type	Chainsaw	Nose Bar Type	Bar Length	Pitch	Gauge	Bar	Loop	Bar Cover
------	----------	---------------	------------	-------	-------	-----	------	-----------

CHAINSAW BARS, LOOPS & COVERS

Type	Chainsaw	Nose Bar Type	Bar Length	Pitch	Gauge	Bar	Loop	Bar Cover
Cordless								
	DUC305Z	Sprocket	30cm / 12"	3/8"	0.043"	165245-8	196740-7	419288-5
	DUC355Z	Sprocket	35cm / 14"	3/8"	0.043"	165246-6	196741-5	419288-5
	DUC405Z	Sprocket	40cm / 16"	3/8"	0.043"	165247-4	196742-3	419242-9
	DUC353Z	Sprocket	35cm / 14"	3/8"	0.043"	165246-6	196741-5	419288-5
	DUC302Z	Sprocket	30cm / 12"	3/8"	0.043"	165245-8	196740-7	419288-5
	DUC254Z	Sprocket	25cm / 10"	3/8"	0.043"	161846-0	199075-5	458501-6
	DUC256Z	Sprocket	25cm / 10"	3/8"	0.043"	161846-0	199075-5	458501-6
	DUC306Z	Sprocket	30cm / 12"	3/8"	0.043"	165245-8	196740-7	419288-5
	Electric	UC3541A/2	Sprocket	35cm / 14"	3/8"	0.050"	165201-8	196212-2
UC4041A/2		Sprocket	40cm / 16"	3/8"	0.050"	165202-6	196213-0	419242-9
UC3551A		Sprocket	35cm / 14"	3/8"	0.005"	165201-8	196212-2	419288-5
UC4051A		Sprocket	40cm / 16"	3/8"	0.050"	165202-6	196213-0	419242-9
Petrol		DCS230T	Sprocket	25cm / 10"	3/8"	0.050"	168407-7	194098-8
	EA3201S35B	Sprocket	35cm / 14"	3/8"	0.050"	165246-6	196212-2	419559-0
	EA3500S35B	Sprocket	35cm / 14"	3/8"	0.050"	165201-8	511291752	419559-0
	EA3500S40B	Sprocket	40cm / 16"	3/8"	0.050"	165202-6	511291752	419560-5
	EA3501S35B	Sprocket	35cm / 14"	3/8"	0.050"	165201-8	196208-3	419560-5
	EA3601F35B	Sprocket	35cm / 14"	3/8"	0.050"	165201-8	196212-2	419559-0
	EA3601F40B	Sprocket	40cm / 16"	3/8"	0.050"	165202-6	196208-3	419560-5
	EA4300F38C	Sprocket	38cm / 15"	0.325"	0.050"	444038141	512484764	419560-5
	EA4300F45C	Sprocket	45cm / 18"	0.325"	0.050"	444045141	532484072	419560-5
	EA5000P45D	Sprocket	45cm / 18"	0.325"	0.058"	445045631	528086672	952020650
					3/8"	415045651	523093664	
							958086672	
	EA5600F45D	Sprocket	45cm / 18"	3/8"	0.058"	415045651	523093664	952020650
	EA6100P45D	Sprocket	45cm / 18"	0.325"	0.058"	445045531	958086672	952020650
							528086672	
	EA7300P45E	Sprocket	45cm / 18"	3/8"	0.058"	455045655	528099668	952020650
	EA7900P45E	Sprocket	45cm / 18"	3/8"	0.058"	455045655	528099668	952020650

Part No.

Details

RESCUE BLADES AND CHAINS



957415030	Rescue cut chain kit 38cm(15")
957415040	Rescue cut chain kit 45cm(18")

CHAIN 100FT REELS



511492801	Semi-chisel 092 3/8" 0.050
523093801	Semi-chisel 093 3/8" 0.058
528099801	Full-chisel 099 3/8" 0.058
523110801	Semi-chisel 110 3/8" 0.063
957291801	3/8 1.1mm 90PX (1637) A
957492801	3/8 1.3mm 91PX (1637) B
957093801	3/8 1.5mm 73DP (1637)
957099801	3/8 1.5mm 73LP (1637) E
957086801	.325 1.5mm 21BP (1637)
957686801	.325 1.5mm 21LP (1848) D
957480801	3/8 1.3mm 91VXL (1637)
957466801	1/4 1.3mm 25AP (2392) F
957100801	3/8 1.3mm 72LP (1637)
957110801	3/8 1.6mm 75LP (1637)
957484801	.325 1.3mm 95VP (1848) C
957786801	.325 1.6mm 22LP (1848)
957103801	.404 1.6mm 27 (1480)

OTHER CHAINSAW ACCESSORIES



199067-4	Spike Bumper Set DUC254
----------	-------------------------

Part No.

Details

CHAINSAW BARS



958030611	Sprocket Nose Bar 12" 30cm
958035611	Sprocket Nose Bar 14" 35cm
958040611	Sprocket Nose Bar 16" 40cm
958030661	Sprocket Nose Bar 12" 30cm
958035661	Sprocket Nose Bar 14" 35cm
958040661	Sprocket Nose Bar 16" 40cm
442045661	Sprocket Nose Bar 18" 45cm
442030061	Sprocket Nose Bar 30cm (Auto)
168408-5	Guide Bar 10" DCS230T/BUC250
445033631	Nose Sprocket Cpl 33cm 0.325
445038631	Sprocket Nose Bar 38cm .0325
958038651	Sprocket Nose Bar 38cm 15" / 3/8
958045651	Sprocket Nose Bar 3/8"(45cm)
443053451	Sprocket Nose Bar 53cm 3/8
443060451	Solid Nose Bar 24 Inch
445038655	Sprocket Nosebar 38cm Dcs64/79
445045655	Sprocket Nose Bar 45cm/18"
445050655	Sprocket Nose Bar 50cm 20"
445045455	Solid Nose Bar 45cm 18"
445050455	Solid Nose Bar 50cm 20"
445060455	Solid Nose Bar 60cm 24"
445070455	Solid Nose Bar 70cm 28"
445074452	Solid Nose Bar 74cm 29" DCS9

CHAINSAW LOOPS





958291646	Saw Chain 12" UC3010A
958291652	Saw Chain 14" UC3010A
958291656	Saw Chain 16" UC3010A
958492646	Saw Chain 12" 30cm Makita
958492652	Saw Chain 3/8".050 Sc 35cm 14"
958492656	Saw Chain 3/8".050 Sc 40cm 16"
531492662	Saw Chain 45cm
196205-9	Saw Chain Set DCS230T/BUC250
532484056	Saw Chain 33cm
958484664	Saw Chain 38cm
528086656	Saw Chain 13" .325" DCS4300I
958086664	Saw Chain 15".325
523093656	Saw Chain 3/8" 38cm
958099656	Saw Chain 15" DCS6000I/6800I
958099664	Saw Chain 18"
534686056	Saw Chain 0.325/058 33cm-13"
534686064	Saw Chain 0.325/058 38cm-15"
523093656	Saw Chain 3/8" 38cm
523093672	Saw Chain 0.325/058 53cm-21"
528099672	Saw Chain 50-53cm 20-21"72d
528099684	Saw Chain 3/8" 60cm
528099694	Saw Chain 70cm Links
528099680	Saw Chain 24" 60cm
528099696	Saw Chain 3/8" 74cm 0.058"
531492652	Saw Chain 35cm EA3500S/3501S
531492656	Saw Chain 40cm EA3500S/3501S

Batteries & Cases
Tool Holders
Drilling
Fixing
Saw Blades
Jigsaw & Recip
Multi Tool
Diamond
Bonded Abrasives
Flap Discs
Coated Abrasives
Router Cutters
Dust Extraction
Ground Maintenance

GROUND MAINTENANCE, LANDSCAPING AND FORESTRY: BRUSHCUTTER

	Part No.	Diameter mm	Bore mm	Tooth Count	Pack
 <p>For mowing tough, dry grass and reeds.</p>	B-14118	9"	25.4	4	1
	B-14124	10"	25.4	4	1
	D-66008	9"	25.4	4	1
	D-66014	10"	25.4	4	1

	Part No.	Diameter mm	Bore mm	Tooth Count	Pack
 <p>For large areas of tough weeds and heavy grass.</p>	B-14130	9"	25.4	8	1
	B-14146	10"	25.4	8	1

	Part No.	Diameter mm	Bore mm	Tooth Count	Pack
 <p>For bushes and thin tree trunks.</p>	B-14152	9"	25.4	80	1
	B-14168	10"	25.4	80	1

	Part No.	Diameter mm	Bore mm	Tooth Count	Pack
 <p>For bushes and thin tree trunks, sawing and clearing work.</p>	385224171	200	20.0		1
	385224161	225	22.4		1

	Part No.	Diameter mm	Bore mm	Tooth Count	Pack
 <p>For thinning and removing tough grass and shrubs.</p>	385224130	12"	20	3	1
	195298-3	9"	25.4	3	1
	D-66020	9"	25.4	3	1
	D-66036	10"	25.4	3	1
	D-66042	12"	25.4	3	1

	Part No.	Diameter mm	Bore mm	Tooth Count	Pack
 <p>For cutting thick grass. Suitable for wide open spaces.</p>	D-66058	9"	25.4	2	1
	D-66064	10"	25.4	2	1

	Part No.	Diameter mm	Bore mm	Tooth Count	Pack
 <p>Low stone throwing blade.</p>	385224301	255	25.4		1
	385341300			Guard Assembly - K Type Fitting	1

	Part No.	Details
	988048624	Shoulder Strap Assembly
	988048627	Double Shoulder Harness
	126012-6	Single Shoulder Strap
	125516-5	Band Assembly DUR365
	122906-3	Double Shoulder Strap EBH341U
	196129-9	Harness EM4351UH
	126187-1	Band Assembly EM4350LH

	Part No.	Details
	P-21076	Female M10 X 1.0 (L)
	P-21082	Female (Bump & Cut) M10 X 1.25 (L)
	385224510	Female M12 X 1.5 (L)
	P-21107	Female (Bump & Cut) M8 X 1.25 @
	P-21113	Female M8 X 1.25 (L)
	P-21129	Female M10 X 1.25 (L)
	680224600	M8 x 1.25R Comfort Trim Small
	381224230	M10 x 1.25L Comfort Trim Medium/Large
	382224310	Adaptor Trim Pro
	385224250	Adaptor Manual Trim

GROUND MAINTENANCE: LINE TRIMMER

Part No.

Details

NYLON LINE



Rounded trim pro

Round line is for cutting grass. This is the most common line.

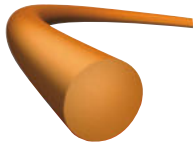

Rounded trim plus



Rounded trim



Square trim pro

Square line is for cutting grass more efficiently due it's sharper edges.



Square trim plus

ROUND TRIM	
369224600	2.0mm x 15m
369224601	2.0mm x 126m
196148-5	1.65mm x 15m
ROUND TRIM PLUS	
369224602	2.4mm x 15m
369224603	2.4mm x 87m
369224604	2.4mm x 262m
SQUARE TRIM PLUS	
369224606	2.4mm x 15m
369224607	2.4mm x 69m
369224608	2.4mm x 206m
ROUND TRIM PRO	
369224609	3.0mm x 15m
369224610	3.0mm x 56m
369224611	3.0mm x 168m
369224612	3.0mm x 279m
SQUARE TRIM PRO	
369224613	3.0mm x 15m
369224614	3.0mm x 44m
369224615	3.0mm x 132m
369224616	3.0mm x 219m

HELICAL-WOUND NYLON LINE - SILENT LINE



Silent Nylon Line

Patented by DOLMAR: Silent Nylon Line. DOLMAR has developed its own nylon line with a helical-wound square cross-section, which has been designed to reduce noise levels (dB(A)) by 15%.

In perceived terms the reduction in noise is much greater – in fact, by nearly 70%. The line is patent protected.

SILENT TRIM PRO	
369224061	2.0mm x 3.5m
369224060	2.0mm x 15m
369224062	2.0mm x 120m
369224071	2.4mm x 3.5m
369224070	2.4mm x 15m
369224072	2.4mm x 120m
369224806	2.7mm x 50pcs use with fix trim
369224673	2.7mm x 15m
369224063	2.7mm x 90m
369224674	3.0mm x 15m
369224073	3.0mm x 70m

NYLON HEADS



680224200	Bump feed small, trim, 2.0mm
382224300	Bump feed large, trim pro, 3.0mm
384224270	Fix trim head, use 369224806
385224240	Manual trim
198971-4	Trimmer head - DUR189
196324-1	Nylon Head Set - EM2511/EM2654
123291-7	Cutter Assembly
198385-7	Cutter Assembly 95-M8L
197030-1	Cutter Assy 154 Set - EM4350RH
198893-8	Cutter Assembly 95-M10L
123235-7	Cutter Assembly 90-M8L - DUR183
195149-0	UN-74L - EM2651UH/LH M10X1.25LH
196589-5	Bump feed ECO4L - BUR182U/L M8X1.25LH
197296-3	Bump feed ECO4L - DUR365U M10X1.25LH
196146-9	Spool AssyL - MDUR141,DUR181
122882-1	Cutter Assembly - EM4351UH
YA00000649	Grass Head Assembly - UR3501
DA00000001	Spool Assy - UR3000
A-89137	Bump feed 4R - ER2550L,ER2600L M8X1.25RH
P-21032	2 Line Head Manual Over 30cc
B-03006	UltraAuto 4R - RST210 M8X1.25RH
B-02945	UltraAuto 4L - M8X1.25LH
B-05125	UltraAuto 4L - M10X1.25LH
A-81658	UltraAuto 6LL - MEBH341U/L/R,EM4340L,EM4350UH/LH M10X1.25LH

FOUR LEAF CLOVER-LIKE NYLON LINE



E-01731	1.65mm x 15m
E-01769	2.0mm x 15m
E-01797	2.4mm x 15m
E-01828	2.7mm x 15m

Batteries & Cases
Tool Holders
Drilling
Fixing
Saw Blades
Jigsaw & Recip
Multi Tool
Diamond
Bonded Abrasives
Flap Discs
Coated Abrasives
Router Cutters
Dust Extraction
Ground Maintenance

GROUND MAINTENANCE: LINE TRIMMER, AUGERS, FLAIL MOWER

	MODEL NO	SPINDLE SIZE	NYLON HEAD 1	LINE SIZE	NYLON HEAD 2	LINE SIZE	NYLON HEAD 3	LINE SIZE	NYLON HEAD 4	LINE SIZE
Cordless	DUR368AZ	M10x1.25LH	196324-1	2.4mm	198893-8	2.0mm	197296-3	2.0mm		
	DUR364LZ	M8x1.25RH	123291-7	2.0mm						
	DUR189Z	M8x1.25RH	198971-4	2.0mm						
	DUR188LZ	M8x1.25LH	198385-7	2.0mm	196589-5	2.0mm	B-02945	2.4mm		
	DUR183LZ	M8x1.25LH	123235-7	2.0mm						
	DUR187LZ	M8x1.25LH	198385-7	2.0mm	196589-5	2.0mm	B-02945	2.4mm		
	DUR181	N/A	196146-9	1.65mm						
	EM404MP	M10x1.25LH	196324-1	2.4mm	198893-8	2.0mm	B-02945	2.4mm	B-05125	2.4mm
	EM406MP	M10x1.25LH	196324-1	2.4mm	198893-8	2.0mm	B-02945	2.4mm	B-05125	2.4mm
	Electric	UR3501	N/A	YA00000649	2.00mm					
UR3000		N/A	DA00000001	1.65mm						
EM2511LH		M10x1.25LH	196324-1	2.4mm	198893-8	2.0mm	B-02945	2.4mm	B-05125	2.4mm
ER2550LH		M8x1.25RH	A-89137	2.4mm						
Petrol	EM2654LH	M10x1.25LH	196324-1	2.4mm	198893-8	2.0mm	B-02945	2.4mm	B-05125	2.4mm
	EM400MP	M10x1.25LH	196324-1	2.4mm	198893-8	2.0mm	B-02945	2.4mm	B-05125	2.4mm
	ER400MP	M8x1.25RH	A-89137	2.4mm	B-03006	2.4mm				
	ER2600L	M8x1.25RH	A-89137	2.4mm	B-03006	2.4mm				
	EM2600L	M8x1.25LH	B-02945	2.4mm	198971-4	2.0mm				
	EBH252U	M10x1.25LH	196324-1	2.4mm	198893-8	2.0mm	B-02945	2.4mm	B-05125	2.4mm
	EBH341U	M10x1.25LH	196324-1	2.4mm	197030-1	3.00mm	A-81658	3.00mm		
	EM4350RH	M10x1.25LH	197030-1	3.00mm	A-81658	3.00mm				
	EM4350UH	M10x1.25LH	197030-1	3.00mm	A-81658	3.00mm				
	EM4351UH	M10x1.25LH	197030-1	3.00mm	A-81658	3.00mm				

Part No.

Details

HEDGE TRIMMER ACCESSORIES



458342-0	Blade cover for hedge trimmer
458345-4	Blade cover EN420MP

AUGERS BBA520

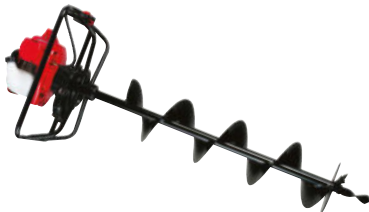

P-49155	3" 80mm
P-49177	5" 120mm
P-49183	6" 150mm
P-49208	8" 200mm

AUGER SPARES

BB750750	Fish Tail, all sizes
BB600470	Wear plate 3" 80mm
BB600150	Wear plate 4" 100mm
BB600450	Wear plate 5" 120mm
BB600460	Wear plate 7" 180mm
BB600180	Wear plate 8" 200mm

PRUNING EXTENSION POLE



195596-5	Extension pole for BUC121
195595-7	Extension pole for BUC122
198516-8	Extension pole for DUM166/168, UM164D

VACUUM SET FOR BLOWERS



197235-3	Vacuum kit set for BXH2500
----------	----------------------------

MOWER BLADES



CORDLESS

196863-1	For DLM380
196060-9	For DLM431Z
199367-2	For DLM460

ELECTRIC

YA00000734	For ELM4121X
YA00000742	For ELM4621X
YA00000731	For ELM3320X
YA00000732	For ELM3720X

PETROL

671001451	For PLM4626N
671014610	For PLM4631N2
DA00000973	For PLM5113N2
671001451	For PLM4622N2
671002532	For PLM5600N2
664004366	For PLM4815
664004381	For PLM5115
DA00000532	For PLM4817
DA00000944	For PLM5121N2

GROUND MAINTENANCE: SPLIT-SHAFT AND BRUSH CUTTER ATTACHMENTS

SPLIT SHAFT BRUSHCUTTER **195652-1 EM400MP**

Attachment for the MM4 Split-Shaft: EX2650LH

- Easy change*
- Cutting width: 420mm



SPLIT SHAFT LINE TRIMMER **195526-6 ER400MP**

Attachment for the MM4 Split-Shaft: EX2650LH

- Easy change*
- Cutting width: 420mm
- Nylon line dia: 2mm
- Bump feed trimmer head



SPLIT SHAFT LINE TRIMMER **198779-6 EM406MP**

Attachment for MM4 Split-Shaft: EX2650LH and Twin 18V Cordless Split-Shaft: DUX60Z

- Easy change*
- Cutting width 420mm
- Perfect for cleaning between bushes



SPLIT SHAFT BRUSHCUTTER **198768-1 EM404MP**

Attachment for MM4 Split-Shaft: EX2650LH and Twin 18V Cordless Split-Shaft: DUX60Z

- Easy change*
- Cutting width 420mm
- Bump feed trimmer head



SPLIT SHAFT POLE SAW **199927-0 EY401MP**

Attachment for MM4 Split-Shaft: EX2650LH and Twin 18V Cordless Split-Shaft: DUX60Z

- Easy change*
- Ideal for branches in tall trees and hard to reach areas



SPLIT SHAFT HEDGE TRIMMER **196256-2 EN401MP**

Attachment for MM4 Split-Shaft: EX2650LH and Twin 18V Cordless Split-Shaft: DUX60Z

- Easy change*
- 135° cutting angle for maximum versatility
- Ideal for trimming hard to reach areas



SPLIT SHAFT EDGER **196752-0 EE400MP**

Attachment for MM4 Split-Shaft: EX2650LH and Twin 18V Cordless Split-Shaft: DUX60Z

- Easy change*
- Overall Length: 878 mm
- Net weight: 2.4 kg
- Cuts through turf to define edge of garden beds, paths and driveways



SPLIT SHAFT CULTIVATOR **195711-1 KR400MP**

Attachment for MM4 Split-Shaft: EX2650LH and Twin 18V Cordless Split-Shaft: DUX60Z

- Easy change*
- Compact design
- Designed to work in tight and compact spaces
- Steel drive shaft



SPLIT SHAFT POWER BRUSH **199318-5 BR400MP**

Attachment for MM4 Split-Shaft: EX2650LH and Twin 18V Cordless Split-Shaft: DUX60Z

- Easy change*
- Width: 600 mm
- Nylon bristles
- For sweeping dust, leaves, light snow, fluffing artificial turf, pavement with cracks or uneven stones



SPLIT SHAFT SWEEPER **199339-7 SW400MP**

Attachment for MM4 Split-Shaft: EX2650LH and Twin 18V Cordless Split-Shaft: DUX60Z

- Easy change*
- Width: 600mm
- 12 Rubber paddles
- Removes pebbles, sand, leaves without damaging grass. Clears away water and light snow from hard pavements



SPLIT SHAFT EXTENSION POLE **196032-4 LE400MP**

Attachment for MM4 Split-Shaft: EX2650LH and Twin 18V Cordless Split-Shaft: DUX60Z

- Easy change*
- Enables operator increase reach when used with pole saw. (Only use one extension at a time)



***Easy Change Attachments**

Add Attachments
Push the selected attachment into the female connector until it locks in place.

Remove Attachments
Press the red button on the shaft and pull the attachment out from the female connector.

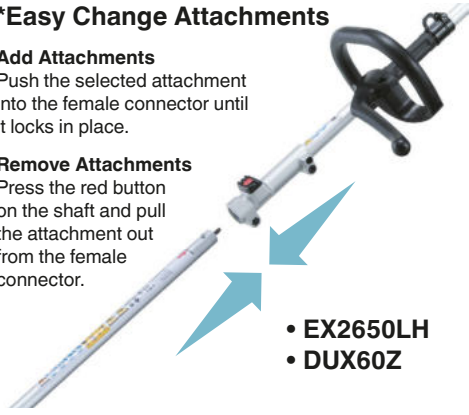

- EX2650LH
- DUX60Z

RBC2510 HEDGE TRIMMER **198584-1**

Attachment for 2-Stroke Brush Cutter: RBC2510

- Converts RBC2510 into a hedge trimmer
- 135° cutting angle for maximum versatility
- Ideal for trimming hard to reach areas



RBC2510 CULTIVATOR **B-04818**

Attachment for 2-Stroke Brush Cutter: RBC2510

- Converts RBC2510 into a cultivator
- Compact design
- Designed to work in tight and compact spaces



Batteries & Cases
Tool Holders
Drilling
Fixing
Saw Blades
Jigsaw & Recip
Multi-Tool
Diamond
Bonded Abrasives
Flap Discs
Coated Abrasives
Router Cutters
Dust Extraction
Ground Maintenance

